

## Overview

### Power Distribution



### Home Accessories



### Plugs and Switches



### Installation Material



### Cables and Tools

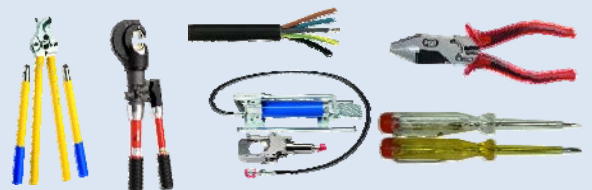

### Fuses and Circuit Breakers



### Time Switches and KWH Meters



### Lamps and Accessories



### Lighting

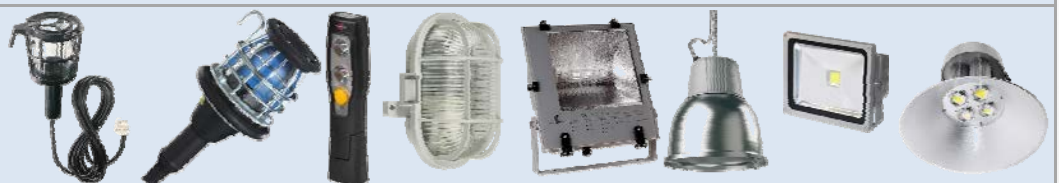

## Industrial Cable Reels - BS

kransstahl®

### KISTENMACHER Cable Reel

- cable reel body made of rust-resistant and galvanised steel
- with 3 x BS socket outlets 240 V with self-closing cover providing protection against dust and contamination
- ergonomic handle and axle for precision cable management when winding and unwinding
- with safety cut-out protection



Art. No.	Cable	Length	Dia
1198057	H05VV-F 3G1,5	25 mtr	240 mm
1198067	H05VV-F 3G1,5	50 mtr	290 mm



galvanised steel body

### Garant Cable Reel

- galvanised frame and steel body
- ergonomic handle and axle for precision cable management when winding and unwinding
- with safety cut-out protection
- 240V, with self-closing cover providing protection against dust and contamination

25 mtr  
50 mtr

20 mtr  
40 mtr



Art. No.	Art. No.	Cable	Length	Dia
1198057900	1198053	H05VV-F 3G1,5	25 mtr	240 mm
1198067900	1198063	H05VV-F 3G1,5	50 mtr	290 mm

Art. No.	Extra Heavy-Duty Cable	Length	Dia
1198113	H05VV-F <b>3G2,5</b>	20 mtr	240 mm
1198093	H05VV-F <b>3G2,5</b>	40 mtr	290 mm

all types come with a galvanised frame and steel body

#### available with:

- 3 x BS socket outlets only

or

- 3 x universal socket system, allows to plug-in BS, US and Euro / Schuko-Plugs

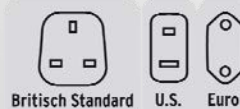

25 mtr  
50 mtr

20 mtr  
40 mtr



Art. No.	Art. No.	Cable	Length	Dia
1218057900	1218053	H05VV-F 3G1,5	25 mtr	240 mm
1208067900	1208063	H05VV-F 3G1,5	50 mtr	290 mm

Art. No.	Extra Heavy-Duty Cable	Length	Dia
1208113	H05VV-F <b>3G2,5</b>	20 mtr	240 mm
1208123	H05VV-F <b>3G2,5</b>	40 mtr	290 mm

#### optionally available

with heavy duty 2,5 sqmm PVC cable (red colour)

- In order to avoid power drops, suitable for generators, high pressure cleaners, welding machines e.g.

all types come with a break-resistant plastic body

## Industrial Cable Reels - BS

brennenstuhl®

### Garant Bretec Cable Reel with the unique Bretec anti cable twist system

- with 3 x BS socket outlets 240V with selfclosing cover providing protection against dust and contamination
- ergonomic handle and axle for precision cable management when winding and unwinding
- with safety cut-out protection



without Bretec



with Bretec



NEW  
CABLEPILOT



BS



galvanised steel body

Art. No.	Cable	Length	Dia
1198867	H05VV-F 3G1,5	50 mtr	290 mm



BS



break-resistant plastic body

Art. No.	Cable	Length	Dia
1208853	H05VV-F 3G1,5	25 mtr	240 mm
1208863	H05VV-F 3G1,5	50 mtr	290 mm

### Super-Solid Cable Reel

- extra stable steel tube frame with new, exclusive stability
- exceptional robust carry handle with comfortable cable guide
- galvanised frame
- with 3 x BS socket outlets 240V cover providing protection against dust and contamination
- with safety cut-out protection
- ergonomic handle and axle for precision cable



with self-closing dust and contamination cover

- with safety cut-out protection



BS



galvanised steel body

Art. No.	Cable	Length	Dia
1309453	H05VV-F 3G1,5	50 mtr	290 mm



BS



break-resistant plastic body, galvanised frame

Art. No.	Cable	Length	Dia
1308953	H05VV-F 3G1,5	50 mtr	290 mm

## Garant Garden Cable Reels

brennenstuhl®

### Garant G Multi-Purpose Reel

- reel body made from special Breflex plastic, galvanized frame
- with BS rubber socket 240 V
- highly flexible Breflex cable with plug and trailing socket
- with cable guide handle für precision cable management
- with safety cut-out protection

25 mtr



special Breflex plastic, galvanised frame

Art. No.	Cable	Length	Dia	Plug
1141743	H05VV-F 3G1,25	25 mtr	240 mm	BS



## Garant CEE Cable Reels

bremerstahl™



### Garant 400 V CEE 1 IP44

water-jet protected version for universal outdoor use

- 1 CEE-plug 400 V / 16 A
- 1 CEE socket 400 V / 16 A
- earthed sockets connected to separate phases
- reel body made from special Breflex plastic on a galvanized frame
- with 3-pin safety cut-out and thermal overload protection
- ergonomic handle and axle for precision cable management

available with 2-way 230V / 16A or 240V / 13A socket outlets with self-closing dust covers



NEW CABLEPILOT

- 20 mtr
- 25 mtr
- 30 mtr



Art. No.	Art. No.	Cable	Length	Dia
1237990	1182773	H07RN-F 5G2,5	20 mtr	320 mm
		AT-N07V3V3-F 5G1,5 flexible, UV & Oil resistant	25 mtr	290 mm
1237980		H07RN-F 5G2,5	30 mtr	320 mm
1182720		H07RN-F 5G1,5	30 mtr	290 mm
1182730		H05VV-F 5G1,5	30 mtr	290 mm

special Breflex plastic, galvanized frame



Art. No.	Art. No.	Cable	Length	Dia
1193200	1193203	H07RN-F 5G2,5	25 mtr	320 mm

galvanized steel body and frame

### Garant 230 V CEE 2 IP 44

water-jet protected version for universal outdoor use

- 1 CEE-plug 230 V / 16 A
- 2 CEE sockets 230 V / 16 A
- reel body made from special Breflex plastic, on a galvanized frame
- with single pole safety cut-off and overheating protection
- ergonomic handle and axle for precision cable management



- 25 mtr
- 40 mtr



Art. No.	Cable	Length	Dia
1182760	H07RN-F 3G2,5	25 mtr	290 mm
1238073	AT-N07V3V3-F 3G2,5 flexible, UV & Oil resistant	40 mtr	320 mm

special Breflex plastic, galvanized frame

### Garant 110 V CEE 2

for every requirement and use

- 2 CEE sockets 110 V / 16 A
- reel body made of special break resistant Breflex rubber
- robust, galvanized steel tube frame
- with cable guide handle für precision cable management
- with safety cut-out protection



NEW CABLEPILOT

- 25 mtr
- 50 mtr



Art. No.	Art. No.	Cable	Length	Dia
1148773	1148853	H05VV-F 3G1,5	25 mtr	240 mm
1138873	1148863	H05VV-F 3G1,5	50 mtr	290 mm
1131953		H05VV-F 3G2,5	25 mtr	240 mm

special Breflex plastic, galvanized frame



with BRETEC anti twist cable system

## Industrial Cable Reels - BS

### Vario Line

- housing made of break-resistant plastic
- practical carrying handle
- twin feet ensure excellent stability
- easy to wind and rewind
- with safety cut-out protection, 240 V

**available with:**

- 3 x BS socket outlets

or

- 3 x universal socket system, allows to plug-in BS, US and Euro / Schuko-Plugs

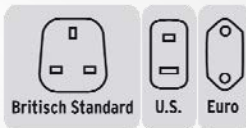

5 mtr  
10 mtr  
15 mtr

10 mtr  
20 mtr

10 mtr  
15 mtr



Art. No.	Art. No.	Cable	Length	Colour
1098207900	1098203	H05VV-F 3G1,5	5 mtr	blue / black
1108567900	1108563	H05VV-F 3G1,5	10 mtr	blue / black
	1108903	H05VV-F 3G1,5	15 mtr	blue / black
	1108553	H05VV-F 3G1,0	10 mtr	grey / black
	1108203	H05VV-F 3G1,0	20 mtr	grey / black
	1093203	H05VV-F 3G1,0	10 mtr	black/black
	1094203	H05VV-F 3G1,0	15 mtr	black/black

### Primera-Line Cable Box

- compact design for comfortable handling
- with a universal handle for both carrying and hanging
- variable use, standing or flat
- robust, rigid construction
- with self-closing cover providing protection against dust and contamination
- with safety cut-out protection
- with 3 x BS socket outlets 240 V

10 mtr



Art. No.	Cable	Length	Colour
1095453	H05VV-F 3G1,5	10 mtr	black / light grey



**robust and rigid construction**

### Comfort Line CL-S

- ergonomic design with a functional and practical rewind ring for easy handling
- with 3 x BS socket outlets 240 V
- with self-closing cover providing protection against dust and contamination
- with safety cut-out protection

3 mtr



3 mtr



Art. No.	Cable	Length	Colour
1109123	05VV-F 3G1,25	3 mtr	black/white
1109223	05VV-F 3G1,5	3 mtr	black/white

Art. No.	Cable	Length	Colour
1109233	05VV-F 3G1,5	3 mtr	black/blue



**break-resistant plastic body**

### Compact Cable Reel AK 180

- reel body made from break-resistant plastic, galvanized frame
- portable and light - lots of cable taking up little space
- with safety cut-out protection
- ergonomic handle and axle for precision cable

**available with:**

- 3 x BS socket outlets or 3 x universal socket system, allows to plug-in BS, US and Euro-Plugs

15 mtr



Art. No.	Art. No.	Cable	Length	Dia
1078187900	1078183004	H05VV-F 3G1,5	15 mtr	180 mm

**break-resistant plastic body, galvanized frame**

## British Standard with BS plug



- with childproof sockets
- illuminated 2-pole ON/OFF safety switch
- earthed sockets in a 45° arrangement, ideal for angular plugs

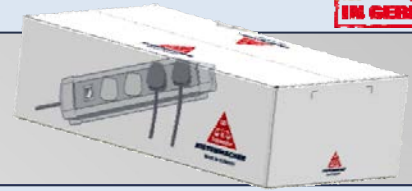

### Premium Line - 4-way



Art. No.	Cable	Length / UP	Colour
1 95114 3 100	05VV-F 3G1.25	1,80 mtr / 4 pieces	Black
1 95554 3 100	05VV-F 3G1.25	1,80 mtr / 4 pieces	Light Grey
1 95154 3 100	05VV-F 3G1.25	1,80 mtr / 4 pieces	Black / Grey
1 95224 3 100	05VV-F 3G1.25	1,80 mtr / 4 pieces	White / White



Art. No.	Cable	Length / UP	Colour
1 95154 3 101	05VV-F 3G1.25	3 mtr / 4 pieces	Black / Grey
1 95154 3 102	05VV-F 3G1.25	5 mtr / 4 pieces	Black / Grey
1 95224 3 102	05VV-F 3G1.25	5 mtr / 4 pieces	White

### Premium Line - 6-way



Art. No.	Cable	Length / UP	Colour
1 95116 3 100	05VV-F 3G1.25	3 mtr / 4 pieces	Black
1 95556 3 100	05VV-F 3G1.25	3 mtr / 4 pieces	Light Grey
1 95156 3 100	05VV-F 3G1.25	3 mtr / 4 pieces	Black / Grey
1 95226 3 100	05VV-F 3G1.25	3 mtr / 4 pieces	White



Art. No.	Cable	Length / UP	Colour
1 95156 3 101	05VV-F 3G1.25	5 mtr / 4 pieces	Black / Grey



Art. No.	Cable	Length / UP	Colour
1 156053 0 24	05VV-F 3G1.25	3 mtr / 4 pieces	Black / Grey

### Premium Line - 8-way



Art. No.	Cable	Length / UP	Colour
1 95118 3 100	05VV-F 3G1.25	3 mtr / 4 pieces	Black
1 95558 3 100	05VV-F 3G1.25	3 mtr / 4 pieces	Light Grey
1 95158 3 100	05VV-F 3G1.25	3 mtr / 4 pieces	Black / Grey
1 95228 3 100	05VV-F 3G1.25	3 mtr / 4 pieces	White

### Premium Alu-Line - 4 / 6 / 8-way

- attractive, timeless sturdy housing made from aluminium matt-finished surface



Art. No.	Cable	Length / UP	Colour
1 39100 3 014	05VV-F 3G1.25	1,80 mtr / 4 pieces	ALU/black
1 39100 3 016	05VV-F 3G1.25	3 mtr / 4 pieces	ALU/black
1 39100 3 018	05VV-F 3G1.25	3 mtr / 4 pieces	ALU/black

## Extension Sockets with BS plug

brennenstuhl®

- with childproof sockets
- illuminated 2-pole ON/OFF safety switch
- competitively priced quality socket outlet rail for DIY, home and office



### Super-Solid-Line 5 + 8 way

- extremely sturdily constructed extension socket made from highly break-resistant polycarbonate & hanging facility
- sockets in 90° arrangements, distance between the sockets allows the use of large charger units

5 way  
8 way

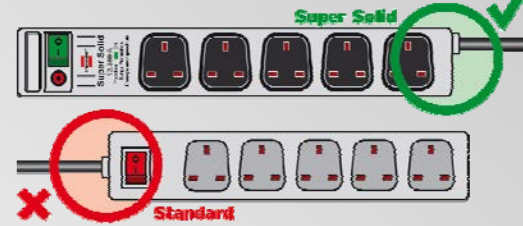

### Eco-Line - 4 + 6 way



4 way



6 way

Art. No.	Cable	Length mtr / UP	Colour
1150403	05VV-F 3G1,25	1,5 mtr / 8 pieces	black
1150423	05VV-F 3G1,25	1,5 mtr / 8 pieces	white
1159503	05VV-F 3G1,25	1,5 mtr / 8 pieces	black
1159523	05VV-F 3G1,25	1,5 mtr / 8 pieces	white

### Primera-Line - 4, 8 and 10 way

- with cable clip for the storage of surplus cable
- option of variable cable output on both sides
- convenient spacing of the sockets

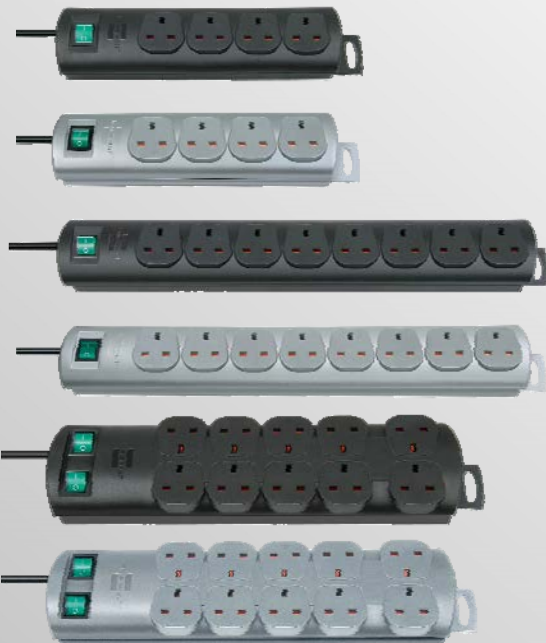

4 way



8 way



10 way

Art. No.	Cable	Length mtr / UP	Colour
1 15330 3 124	05VV-F 3G1.25	1,5 mtr / 4 pieces	black
1 15339 3 124	05VV-F 3G1.25	1,5 mtr / 4 pieces	silver

Art. No.	Cable	Length mtr / UP	Colour
1 15330 3 128	05VV-F 3G1.25	2 mtr / 8 pieces	black
1 15339 3 128	05VV-F 3G1.25	2 mtr / 8 pieces	silver

Art. No.	Cable	Length mtr / UP	Colour
1 15330 3 120	05VV-F 3G1.25	2 mtr / 10 pieces	black
1 15339 3 120	05VV-F 3G1.25	2 mtr / 10 pieces	silver





Premium Multi-Line - Extension Sockets  
British Standard + Euro / US all equipped with BS plug



- 3 or 5 multi sockets with childproof sockets
- illuminated 2-pole ON/OFF safety switch
- exclusive, slim-line and high-quality design
- Innovative and individual fixture system

Multi socket outlet to fit  
US plugs  
SCHUKO plugs  
BS plugs

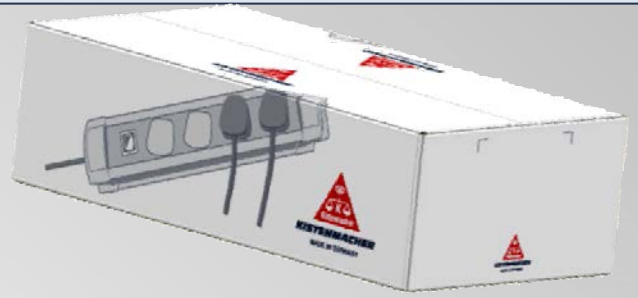
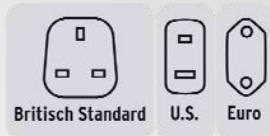

## 3 - way



Art. No.	Cable	Length / UP	Colour
1 95133 7 900	05VV-F 3G1.25	3 mtr / 4 pieces	Black / Blue
1 96013 7 724	05VV-F 3G1.25	3 mtr / 4 pieces	Light Grey / Blue
1 95153 7 900	05VV-F 3G1.25	5 mtr / 4 pieces	Black / Light Grey
1 96033 7 724	05VV-F 3G1.25	5 mtr / 4 pieces	Light Grey

## 5 - way



Art. No.	Cable	Length / UP	Colour
1 15600 7 135	05VV-F 3G1.25	3 mtr / 4 pieces	Black
1 15600 7 155	05VV-F 3G1.25	5 mtr / 4 pieces	Black



Art. No.	Cable	Length / UP	Colour
1 156057 1 35	05VV-F 3G1.25	3 mtr / 4 pieces	Black / Grey
1 15605 7 155	05VV-F 3G1.25	5 mtr / 4 pieces	Black / Grey



Art. No.	Cable	Length / UP	Colour
1 15603 7 135	05VV-F 3G1.25	3 mtr / 4 pieces	Black / Blue



Art. No.	Cable	Length / UP	Colour
1 15655 7 135	05VV-F 3G1.25	3 mtr / 4 pieces	Light Grey
1 15655 7 155	05VV-F 3G1.25	3 mtr / 4 pieces	Light Grey



Art. No.	Cable	Length / UP	Colour
1 15650 7 135	05VV-F 3G1.25	3 mtr / 4 pieces	Grey / Black
1 15650 7 155	05VV-F 3G1.25	5 mtr / 4 pieces	Grey / Black

## Alu Multi-Line



Art. No.	Cable	Length / UP	Colour
1 39100 7 135	05VV-F 3G1.25	3 mtr / 4 pieces	ALU / black
1 39100 7 155	05VV-F 3G1.25	5 mtr / 4 pieces	ALU / black

## Office Multi-Line



Art. No.	Cable	Length / UP	Colour
1 156037 1 415	05VV-F 3G1.25	3 mtr / 4 pieces	black / blue



Art. No.	Cable	Length / UP	Colour
1 15605 7 415	05VV-F 3G1.25	3 mtr / 4 pieces	black / grey



## Premium-Line - Extension Sockets British Standard with BS plug and Fuse Switch



- with childproof sockets
- illuminated 2-pole ON/OFF safety switch
- earthed sockets in a 45° arrangement, ideal for angular plugs
- advanced „fuse switch reset technology“ eliminates time consuming plug fuse replacement. Simply resettable in case of overload by a „switch OFF/ON“ with extra H/D cable 3G1.5mm for high product safety

SASO 2815



### Premium Line - 4 way



Art. No.	Cable	Length / UP	Colour
1 95114 3 603	H05VV-F 3G1.5	3 mtr / 4 pieces	Black
1 95154 3 603	H05VV-F 3G1.5	3 mtr / 4 pieces	Black / Grey



Art. No.	Cable	Length / UP	Colour
1 95114 3 604	H05VV-F 3G1.5	5 mtr / 4 pieces	Black

### Premium Line - 6 way



Art. No.	Cable	Length / UP	Colour
1 95116 3 602	H05VV-F 3G1.5	3 mtr / 4 pieces	Black
1 95156 3 602	H05VV-F 3G1.5	3 mtr / 4 pieces	Black / Grey



Art. No.	Cable	Length / UP	Colour
1 95116 3 603	H05VV-F 3G1.5	5 mtr / 4 pieces	Black

### Premium Line - 8 way



Art. No.	Cable	Length / UP	Colour
1 95118 3 601	H05VV-F 3G1.5	3 mtr / 4 pieces	Black

### Premium Alu-Line - 4 + 6 way

- attractive, timeless sturdy housing made from aluminium matt-finished surface



4 way



6 way

Art. No.	Cable	Length / UP	Colour
1 39100 3 644	H05VV-F 3G1.5	3 mtr / 4 pieces	ALU / Black
1 39100 3 654	H05VV-F 3G1.5	5 mtr / 4 pieces	ALU / Black
1 39100 3 646	H05VV-F 3G1.5	3 mtr / 4 pieces	ALU / Black

### Super-Solid Line - 5 + 8 way

- extremely sturdily constructed extension socket made from highly break-resistant polycarbonate & hanging facility
- sockets in 90° arrangements, distance between the sockets allows the use of large charger units

5 way

8 way

Art. No.	Cable	Length mtr / UP	Colour
1 15334 3 625	H05VV-F 3G1.5	2,5 mtr / 1 piece	Black / Light grey
1 15334 3 628	H05VV-F 3G1.5	2,5 mtr / 1 piece	Black / Light grey



## Alu Office-Line Extension Sockets



- for convenient connection of data processing / Video and audio sets directly with different appliances on the desk.
- elegant, ageless desktop design made from aluminium with unsusceptible, matt-finished surface



Art. No.	Cable	Length mtr / UP	Colour
1 39400 3 416	05VV-F 3G1.25	3 mtr / 1 piece	Grey / Black

## Premium Office-Line Extension Sockets

- for convenient connection of data processing / Video and audio sets directly with different appliances on the desk.
- elegant, ageless desktop design made from extremely durable special synthetic material



Art. No.	Cable	Length mtr / UP	Colour
1 15625 3 416	05VV-F 3G1.25	3 mtr / 1 piece	Black / Light Grey

## hugo! colourful, stylish, cool - 4 way Extension Sockets

- shapely and stable enclosure due to polished, highly break-proof polycarbonate
- illuminated 2-pole ON/OFF safety switch
- with widely spaced sockets positioned at a 90° angle
- with childproof sockets
- with mounting facilities for all installation
- in blister packing

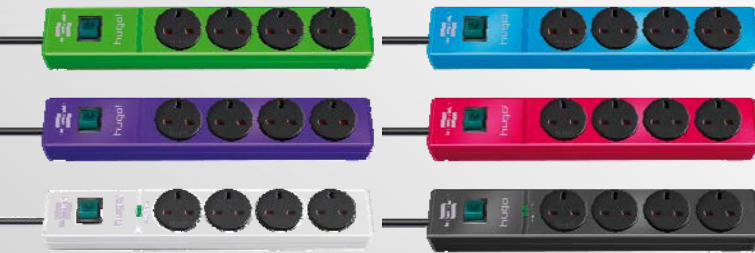

Art. No.	Cable	Length mtr / UP	Colour
1 15061 3 194	05VV-F 3G1.25	2 mtr / 2 pieces	green
1 15061 3 184	05VV-F 3G1.25	2 mtr / 2 pieces	blue
1 15061 3 134	05VV-F 3G1.25	2 mtr / 2 pieces	violet
1 15061 3 174	05VV-F 3G1.25	2 mtr / 2 pieces	rubin-red
1 15061 3 124	05VV-F 3G1.25	2 mtr / 2 pieces	white
1 15061 3 114	05VV-F 3G1.25	2 mtr / 2 pieces	black

## hugo! colourful, stylish, cool - 8 way Extension Sockets



Art. No.	Cable	Length mtr / UP	Colour
1 15061 3 198	05VV-F 3G1.25	3 mtr / 2 pieces	green
1 15061 3 188	05VV-F 3G1.25	3 mtr / 2 pieces	blue
1 15061 3 138	05VV-F 3G1.25	3 mtr / 2 pieces	violet
1 15061 3 178	05VV-F 3G1.25	3 mtr / 2 pieces	rubin-red
1 15061 3 128	05VV-F 3G1.25	3 mtr / 2 pieces	white
1 15061 3 118	05VV-F 3G1.25	3 mtr / 2 pieces	black

## Premium-Line Surge Protection 30.000 A - 4-way

**brennenstuhl**



Art. No.	Cable	Length / UP	Surge	Colour	Plug
1 15605 3 374	05VV-F 3G1,25	1,8 mtr / 2 pcs.	30 KA	black/grey	BS
1 15605 3 394	05VV-F 3G1,25	3 mtr / 2 pcs.	30 KA	black/grey	BS

+ EMV/RFI Filter



- The Brennenstuhl range of multi-way socket outlets with surge suppressor and lightning protection fuse offer effective protection against power surges and high voltage peaks.
- Unless connected appliances like your PC, TV, Hifi, fax machine or other sensitive electric appliances are not effectively protected, severe damage will be unavoidable. Most dangerous are very high voltage peaks caused by starting heavy machinery or by indirect lightning strikes.
- Safety elements like varistors or gas conductors are essential parts in order to divert voltage surges within milli-seconds through the earth connection. No destructive voltage peaks will therefore be able to reach the interior of your sensitive electric appliances. The modern and high quality safety elements used by Brennenstuhl guarantee effective protection against power surges and indirect lightning strikes up to 30.000 Amps.
- Light indicating surge voltage is active.
- Protects sensitive electronics from high frequency interference voltages.

## hugo! colourful, stylish, cool - 19.500 A

- protects expensive devices from overloads with a max. leakage current of up to 19.500 A
- optical function display for overload protection
- **shapely and stable enclosure due to polished, highly break-proof polycarbonate**
- Illuminated 2-pole ON/OFF safety switch
- with widely spaced sockets positioned at a 90° angle
- with childproof sockets
- with mounting facilities for all installation
- in blister packing



4 way



Art. No.	Cable	Length / UP	Colour
1 15061 3 3 74	05VV-F 3G1,25	2 mtr / 1 piece	rubin-red
1 15061 3 324	05VV-F 3G1,25	2 mtr / 1 piece	white
1 15061 3 314	05VV-F 3G1,25	2 mtr / 1 piece	anthracite



6 way



Art. No.	Cable	Length / UP	Colour
1 15061 3 378	05VV-F 3G1,25	3 mtr / 1 piece	rubin-red
1 15061 3 328	05VV-F 3G1,25	3 mtr / 1 piece	white
1 15061 3 318	05VV-F 3G1,25	3 mtr / 1 piece	anthracite

## Eco-Line Surge Protection 4.500 A - 5-way



Art. No.	Cable	Length / UP	Surge	Colour	Plug
1 15675 3	05VV-F 3G1,25	2 mtr / 4 pieces	13.500 A	anthracite	BS

- the competitively priced quality socket outlet rail for DIY, home and office
- prevents damage of destruction from voltage peaks and provides effective protection against indirect lighting strikes.
- suitable for wall fixing
- light indicating surge voltage is active.
- illuminated 2-pole ON/OFF safety switch and surge neon indicator

## Travel Adapter Earthed/GB



Art. No.	Packing Unit	Max. load
1 50853 3	5	13 A / 250 V

### Travel Adapter Earthed /GB

Adapter enabling electrical equipment using an earthed socket system

- This travel adapter is not a transformer or a frequency converter.
- 13 A fuse
- Childproof socket.
- In blister packing

## Travel Adapter GB/Earthed



Art. No.	Packing Unit	Max. load
1 50853 0	5	13 A / 250 V

### Travel Adapter GB/Earthed

Adapter enabling electrical equipment using British plug system to be used in

Countries using an earthed socket system, e.g. DE, FR, BE, PL, NL, ES, PT,

- This travel adapter is not a transformer or a frequency converter.
- Childproof socket.
- In blister packing

## Travel Adapter Earthed/USA, Japan



Art. No.	Packing Unit	Max. load
1 50855 0	5	15 A / 125 V

### Travel Adapter Earthed/USA, Japan

Adapter enabling electrical equipment using the USA or Japanese earthed plug system in countries using an earthed socket system.

- This travel adapter is not a transformer or a frequency converter.
- Childproof socket.

## World Travel Adapter BWA + / BWA USB



Art. No.	Packing Unit	Input Voltage	Max. load
1 50849 0	1	100 V - 250 V	10 A

### World Travel Adapter BWA +

The World Adapter BWA + ensures simple and safe connection of 2- and 3-pole devices from across the world in more than 150 countries

- Suitable for equipment with earthed & unearthed plugs (2- and 3-pole).
- Receptacles for: Switzerland, Italy, Australia/China, UK, USA, Europe (earthed and 2-pole Euro)
- Retractable plugs: Switzerland, Italy, Australia/China, UK, USA, Europe (earthed).



Art. No.	Packing Unit	Input Voltage	Max. load	Further information	Equipment
1 50839 0	1	100 V - 250 V	2,5 A	T2.5 A integrated fuse	2 spare fuses included

### World Travel Adapter BWA USB

The World Adapter BWA + ensures simple and safe connection of 2- and 3-pole devices from across the world in more than 150 countries

- Suitable for equipment with earthed & unearthed plugs.
- Receptacles for: Australia/China, Euro, UK, USA/Japan.
- Retractable plugs: Australia/China, Euro, UK, USA/Japan..

## Primera-Line Remote Control SET RC 3600

brennstuhl®



- easy to use 4 channel hand transmitter to switch all channels
- remote control and receiver socket, any combination
- sockets can be operated manually
- selflearning coding, automatic storage
- **switching capacity 3120W**
- range up to 25 mtr (frequency 433,92 Mhz)
- 12V battery (type A23) for remote control included
- childproof socket



Art. No.	UP	Plug
1 50747 3	6 pieces	BS
1 50747 0	1 piece	Schuko

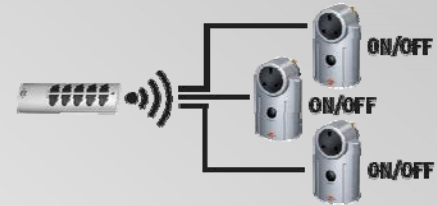

## Primera-Line Digital Weekly Timer DT



- extra large display for days, hours in 12 and 24 hour-format, minutes and seconds
- 20 ON/OFF programmes for day, hour and minute setting
- easy 4 button operation, summer / winter time, manual ON / OFF,
- shortest switching-time 1 minute
- countdown and random function
- Programm: interruption during operation is possible
- data memory in case of power cut
- childproof socket
- 2 batteries AG 13 (LR44) inclusive



Art. No.	UP	Plug
1 50750 3	6 pieces	BS
1 50750 0	2 pieces	Schuko



## 24 hour Timer MZ 20



- up to 96 on/off switching times per day can be set
- shortest switching time: 15 minutes
- easy to set
- childproof socket
- in blister packing



Art. No.	UP	Plug
1 50645 3	6 pieces	BS
1 50645 0	6 pieces	Schuko



## Walkie-Talkie



### PMR Walkie-Talkie TRX 3500

- communication up to a distance of 5km
- easy to use, small, handy and robust
- LC display with background lighting
- eight channels with automatic channel search
- four ring tones
- socket for headphone / microphone
- battery monitoring
- 8 AA batteries required per set (*not included*)



Art. No.	UP
1 290 94 0	1 piece

## Fire Blankets BLD 01



### Fire Blanket BLD-01

- certified DIN EN 1869:997
- high quality glass fibre
- both sides coated
- extinguish fires in seconds, ideal for home and work

Art. No.	UP	Packing	Size cm
1 29120 0	6 pieces	hardbox	100 x 100

## Smoke Detector



Smoke

### Smoke Alarm BR 1211 Interlink

- for a wireless radio network of up to 12 smoke detectors
- photoelectric detector, tested in accordance with EN 14604
- optical function display, with test button for the functional check
- inclusive mute switching function
- shrill acoustic alarm (85dB)
- acoustic signal when the battery is low
- 9 V battery included
- size: 27 x 100 mm
- in blister packing

Art. No.	UP	Sound	Battery
1 29002 0	1 piece	85 dB	1 x 9 V



networking



Smoke

### Smoke Alarm BR 166

- photoelectric detector, tested in accordance with EN 14604
- optical function display, with test button for the functional check
- shrill acoustic alarm (85 dB)
- acoustic signal when the battery is low
- 9 V battery included
- size: 35 x 110 mm
- in blister packing

Art. No.	UP	Sound	Battery
1 29022 0	1 piece	85 dB	1 x 9 V



Smoke

### Smoke Alarm BR 1201 basic / BR 8221 extra longlife

- photoelectric detector, tested in accordance with EN 14604
- optical function display, with test button for the functional check
- inclusive mute switching function (only for Art. 1290800)
- shrill acoustic alarm (85 dB)
- acoustic signal when the battery is low
- battery is included
- size: 30 x 85 mm
- in blister packing



Art. No.	UP	Sound	Battery / life
1 29001 0	1 piece	85 dB	1 x 9 V / 5 years
1 29080 0	1 piece	85 dB	1 x 3 V fixed / 10 years

## Heat Detector



Heat

### Heat Detector BH 1201

- warning light and acoustic signal
- short reaction time at a temperature increase to over 55°C
- function test button
- with battery monitoring feature
- 9V battery included
- for use in kitchen garage or in closed rooms where a smoke detector is not suitable because of the formation of steam from cooking, exhaust gases or dust

Art. No.	UP	Sound	Battery
1 29045 0	1 piece	85 dB	1 x 9V



## CO Detector



Carbon

### CO Detector BCN 1221

- use in garages, living quarters with open fire places/camping
- durable, modern electro-chemical sensor
- alarm signal and LED display
- regular self-testing
- shrill alarm 85dB
- warning signal when battery is running low
- battery operated 9V, can be installed anywhere

Art. No.	UP	Sound	Packaging
1 29049 0	1 piece	85 dB	Blister
1 29049 0 012	1 piece	85 dB	Display



### KISTENMACHER Cable Reel

- cable reel body made of rust-resistant and galvanised steel
- with 4 x Schuko socket outlets with self-closing cover providing protection against dust and contamination
- ergonomic handle and axle for precision cable management when winding and unwinding
- with safety cut-out protection



25 mtr  
50 mtr



Art. No.	Cable	Length	Dia
1198067	H05VV-F 3G1,5	25 mtr	240 mm
1195067	H05VV-F 3G1,5	50 mtr	240 mm

Schuko



*galvanised steel body*

### Garant Cable Reel

- with 4 x Schuko socket outlets with self-closing cover providing protection against dust and contamination
- ergonomic handle and axle for precision cable management when winding and unwinding
- galvanised steel frame
- with safety cut-out protection



25 mtr  
50 mtr



Art. No.	Cable	Length	Dia
1195056	H05VV-F 3G1,5	25 mtr	290 mm
1195066	H05VV-F 3G1,5	50 mtr	290 mm

Schuko



*galvanised steel body*

25 mtr  
50 mtr



Art. No.	Cable	Length	Dia
1215056	H05VV-F 3G1,5	25 mtr	240 mm
1205066	H05VV-F 3G1,5	50 mtr	290 mm

Schuko



*break-resistant plastic body*

### Garant Bretec Cable Reel

with the unique Bretec anti cable twist system

- with 4 x Schuko socket outlets with self-closing cover providing protection against dust and contamination
- ergonomic handle and axle for precision cable management when winding and unwinding
- with safety cut-out protection



25 mtr  
50 mtr



Art. No.	Cable	Length	Dia
1208850	H05VV-F 3G1,5	25 mtr	240 mm
1208860	H05VV-F 3G1,5	50 mtr	290 mm

Schuko



*break-resistant plastic body*

The one has got a Bretec:  
the other's got a mess.



## Industrial Cable Reels - Schuko

### Vario Line

- robust casing, made of special plastic
- with 4 x Schuko socket outlets
- practical carrying handle
- twin feet ensure excellent stability
- with safety cut-out
- with childproof sockets



black / grey      black / blue      black / bordeaux / grey      black / blue / grey

5 mtr

10 mtr

15 mtr

5,10,20 mtr

Art. No.	Cable	Length	Colour
1092200	H05VV-F 3G1,5	5 mtr	black / grey
1093200	H05VV-F 3G1,5	10 mtr	black / grey
1093230	H05VV-F 3G1,5	10 mtr	black / blue / grey
1093270	H05VV-F 3G1,5	10 mtr	black / bordeaux / grey
1094200	H05VV-F 3G1,5	15 mtr	black / grey
1092106	H05VV-F 3G1,0	5 mtr	black / blue
1103466	H05VV-F 3G1,0	10 mtr	black / blue
1102206	H05VV-F 3G1,0	20 mtr	black / blue

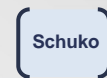

**break-resistant plastic body**

### Comfort Line CL-S

- ergonomic design with a functional and practical rewind ring for easy handling
- with 4 x Schuko socket outlets
- with safety cut-out
- with childproof sockets



3 mtr

Art. No.	Cable	Length	Colour
1109220	H05VV-F 3G1,5	3 mtr	black / white
1109230	H05VV-F 3G1,5	3 mtr	black / blue



**break-resistant plastic body**

### Compact Cable Reel

- reel body made from break-resistant plastic, galvanized frame
- with 4 x Schuko socket outlets
- portable and light - lots of cable taking up little space
- with safety cut-out protection
- with childproof sockets



3 mtr

Art. No.	Cable	Length	Dia
1079180004	H05VV-F 3G1,5	15 mtr	180 mm

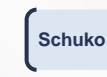

**break-resistant plastic body**

## Garant Garden Cable Reels

### Garant G Multi-Purpose Reel

- reel body made from special Breflex plastic, galvanized frame
- with BS rubber socket 240 V
- highly flexible Breflex cable with plug and trailing socket
- with cable guide handle für precision cable management
- with safety cut-out protection



25 mtr

50 mtr

Art. No.	Cable	Length	Dia	Plug
1141740	HO5VV-F 3G1,25	25 mtr	240 mm	Schuko
1181750	HO5VV-F 3G1,25	50 mtr	290 mm	Schuko

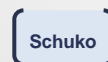

**special Breflex plastic, galvanized frame**

### Garant Bretec 290R Garden Cable Reel

- with the perfect quick and easy rewind ROL' UP and BRETEC anti cable twist system
- with 16 A Schuko plug and socket
- with cable guide handle für precision cable management
- with safety cut-out protection
- extremely sturdy, very flexible to -35°C, UV- and oil resistant and extremely non-abrasive cable



50 mtr

Art. No.	Cable	Length	Dia
1326840	<b>AT-N05V3V3-F 3G1,5 flexible, UV &amp; Oil resistant</b>	50 m	290 mm

**special Breflex plastic, galvanized frame**





## Premium-Line - Extension Sockets Schuko Standard with Schuko plug

breitenstuhl®



- with childproof sockets
- illuminated 2-pole ON/OFF safety switch
- earthed sockets at 45° angles, for angled plugs as well



### Premium Line - 4-way



Art. No.	Cable	Length mtr / UP	Colour
1155220014	H05VV-F 3G1.5	1,8 mtr / 4 pieces	black/blue
1155110014	H05VV-F 3G1.5	1,8 mtr / 4 pieces	white/white
1155110014	H05VV-F 3G1.5	1,8 mtr / 4 pieces	black/black
1155550014	H05VV-F 3G1.5	1,8 mtr / 4 pieces	grey/grey
1155170014	H05VV-F 3G1.5	1,8 mtr / 4 pieces	black/bordeaux
1155150014	H05VV-F 3G1.5	1,8 mtr / 4 pieces	black/grey
1155550014	H05VV-F 3G1.5	1,8 mtr / 4 pieces	light grey/black
1158150014	H05VV-F 3G1.5	5 mtr / 4 pieces	black/grey

### Premium Line - 6-way



Art. No.	Cable	Length mtr / UP	Colour
1156030016	H05VV-F 3G1.5	3 mtr / 4 pieces	black/blue
1156220016	H05VV-F 3G1.5	3 mtr / 4 pieces	white/white
1156110016	H05VV-F 3G1.5	3 mtr / 4 pieces	black/black
1156550016	H05VV-F 3G1.5	3 mtr / 4 pieces	grey/grey
1156170016	H05VV-F 3G1.5	3 mtr / 4 pieces	black/bordeaux
1156150016	H05VV-F 3G1.5	3 mtr / 4 pieces	black/grey
1156510016	H05VV-F 3G1.5	3 mtr / 4 pieces	light grey/black
1156150016	H05VV-F 3G1.5	5 mtr / 4 pieces	black/grey

### Premium Line - 8-way



Art. No.	Cable	Length mtr / UP	Colour
1156150018	H05VV-F 3G1.5	3 mtr / 4 pieces	black/grey
1156220018	H05VV-F 3G1.5	3 mtr / 4 pieces	white/white
1156110018	H05VV-F 3G1.5	3 mtr / 4 pieces	black/black
1156550018	H05VV-F 3G1.5	3 mtr / 4 pieces	grey/grey
1156510018	H05VV-F 3G1.5	3 mtr / 4 pieces	light grey/black
1158000018	H05VV-F 3G1.5	5 mtr / 4 pieces	black/grey

### Premium Line - 10-way



Art. No.	Cable	Length mtr / UP	Colour
1156150010	H05VV-F 3G1.5	3 mtr / 4 pieces	black/grey
1156220010	H05VV-F 3G1.5	3 mtr / 4 pieces	white/white
1156110010	H05VV-F 3G1.5	3 mtr / 4 pieces	black/black
1156550010	H05VV-F 3G1.5	3 mtr / 4 pieces	grey/grey
1156510010	H05VV-F 3G1.5	3 mtr / 4 pieces	light grey/black

## Door Chimes



300

Art. No.	Power	Colour	Size mm
300	220-240 V	White	160 x 160 x 45
300 BIV	220/127 V	White	160 x 160 x 45



white

### Gold Plated Inlet

two note, electromechanical system  
connection: direct to mains  
220-240V AC, 220/127V AC

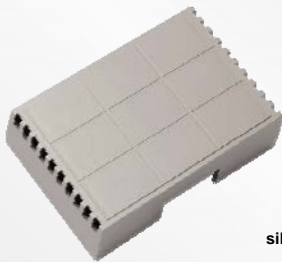

2201

Art. No.	Power	Colour	Size mm
2201 WE 240	220-240 V	White	119 x 82 x 36
2201 WE 240	220/127 V	Silver	119 x 82 x 36



white

two note, electrical system  
connection: direct to mains  
220-240V AC, 220/127V AC



77

Art. No.	Power	Colour	Size mm
77 WE 240	220-240 V	white	113 x 80 x 42
77 GE 240	220-240 V	pastel yellow	113 x 80 x 42
77 GR 240	220-240 V	pale grey	113 x 80 x 42
77 WE BIV	220/127 V	white	113 x 80 x 42
77 GE BIV	220/127 V	pastel yellow	113 x 80 x 42
77 GR BIV	220/127 V	pale grey	113 x 80 x 42



pale grey



pastel yellow

white

two note, electromechanical system  
connection: direct to mains  
220-240V AC, 220/127V AC



85

Art. No.	Power	Colour	Size mm
85 WE 240	220-240 V	white	115 x 115 x 45
85 GE 240	220-240 V	pastel yellow	115 x 115 x 45
85 GR 240	220-240 V	pale grey	115 x 115 x 45
85 WE BIV	220/127 V	white	115 x 115 x 45
85 GE BIV	220/127 V	pastel yellow	115 x 115 x 45
85 GR BIV	220/127 V	pale grey	115 x 115 x 45



pale grey



pastel yellow

white

two note, electromechanical system  
connection: direct to mains  
220-240V AC, 220/127V AC



880

Art. No.	Power	Colour	Size mm
880 WE 240	220-240 V	white	150 x 150 x 45
880 GE 240	220-240 V	pastel yellow	150 x 150 x 45
880 BL 240	220-240 V	pale blue	150 x 150 x 45
880 GN 240	220-240 V	pastel green	150 x 150 x 45
880 WE BIV	220/127 V	white	150 x 150 x 45
880 GE BIV	220/127 V	pastel yellow	150 x 150 x 45
880 BL BIV	220/127 V	pale blue	150 x 150 x 45
880 GN BIV	220/127 V	pastel green	150 x 150 x 45



pastel yellow



pastel blue



pastel green

white

two note, electromechanical system  
connection: direct to mains  
220-240V AC, 220/127V AC

## Door Chimes



Art. No.	Power	Colour	Size mm
900 WE 240	220-240 V	white	215 x 130 x 92
900 WE BIV	220/127 V	white	215 x 130 x 92



900

white

three note, electronic with 2 loudspeaker  
connection: direct to mains  
220-240V AC, 220/127V AC

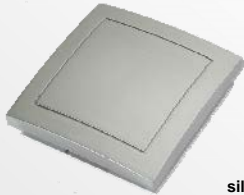

silver

Art. No.	Power	Colour	Size mm
2250 WE 240	220-240 V	white	132 x 132 x 43
2250 WE BIV	220/127 V	white	132 x 132 x 43
2250 SI 240	220-240 V	silver	132 x 132 x 43
2250 SI BIV	220/127 V	silver	132 x 132 x 43



2250

white

two note, electrical system  
connection: direct to mains  
220-240V AC, 220/127V AC



Art. No.	Power	Colour	Size mm
106 WE/SI 240	220-240 V	white / metallic silver	166 x 112 x 45
106 WE/SI BIV	220/127 V	white / metallic silver	166 x 112 x 45
106 TR WE/SI	with trafo	white / metallic silver	166 x 112 x 45



106

white /  
metallic silver

two note, electromechanical system  
1.) connection: direct to mains 220-240V AC, 220/127V AC  
2.) connection: mains 230 V AC through built-in bell-transformer 8V, 1A



Art. No.	Power	Colour	Size mm
405 WE 240	220-240 V	white	235 x 160 x 72
405 WE BIV	220/127 V	white	235 x 160 x 72
405 TR WE	with trafo	white	235 x 160 x 72



405

white

two note, electromechanical system  
1.) connection: direct to mains 220-240V AC, 220/127V AC  
2.) connection: mains 230 V AC through built-in bell-transformer 8V, 1A

## Door Chimes



white

Art. No.	Power	Colour	Size mm
950 WE 240	220-240 V	white	125 x 95 x 35
950 BL 240	220-240 V	pastel blue	125 x 95 x 35
950 GR 240	220-240 V	pale grey	125 x 95 x 35
950 WE BIV	220/127 V	white	125 x 95 x 35
950 BL BIV	220/127 V	pastel blue	125 x 95 x 35
950 GR BIV	220/127 V	pale grey	125 x 95 x 35



pastel blue



pale grey

three note, electronic with one loudspeaker  
connection: direct to mains  
220-240V AC, 220/127V AC

950



pale grey / blue

Art. No.	Power	Colour	Size mm
970 GR/SZ 240	220-240 V	pale grey / black	140 x 77 x 55
970 GR/GE 240	220-240 V	pale grey / yellow	140 x 77 x 55
970 GR/BL 240	220-240 V	pale grey / blue	140 x 77 x 55
970 GR/GN 240	220-240 V	pale grey / green	140 x 77 x 55
970 GR/SZ BIV	220/127 V	pale grey / black	140 x 77 x 55
970 GR/GE BIV	220/127 V	pale grey / yellow	140 x 77 x 55
970 GR/BL BIV	220/127 V	pale grey / blue	140 x 77 x 55
970 GR/GN BIV	220/127 V	pale grey / green	140 x 77 x 55

continuous note, electrical and adjustable  
with one loudspeaker  
connection: direct to mains  
220-240V AC, 220/127V AC



pale grey / black



pale grey / yellow



pale grey / green

970



two note, electronic system  
connection: direct to mains  
220-240V AC, 220/127V AC

Art. No.	Power	Colour	Dia. mm
660 WE/BL 240	220-240 V	white / anthracite	170 x 55
660 WE/BL BIV	220/127 V	white / anthracite	170 x 55



white / anthracite

660



white / silver

Art. No.	Power	Colour	Size mm
103 WE/SI 240	220-240 V	white / metallic silver	166 x 112 x 45
103 WE/BL 240	220-240 V	white / metallic blue	166 x 112 x 45
103 WE/SI BIV	220/127 V	white / metallic silver	166 x 112 x 45
103 WE/BL BIV	220/127 V	white / metallic blue	166 x 112 x 45
103 TR WE/SI	with trafo	white / metallic silver	166 x 112 x 45
103 TR WE/BL	with trafo	white / metallic blue	166 x 112 x 45



white / metallic blue

two note, electromechanical system  
1.) connection: direct to mains 220-240V AC, 220/127V AC  
2.) connection: mains 230 V AC through built-in bell-transformer 8V, 1A

103

## Door Chimes

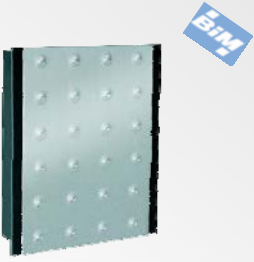

Art. No.	Power	Colour	Size mm
411 AN/ME 240	220-240 V	anthracite / metallic silver	220 x 160 x 47
411 AN/ME BIV	220/127 V	anthracite / metallic silver	220 x 160 x 47
411 TR AN/ME	with trafo	anthracite / metallic silver	220 x 160 x 47
411 SU AN/ME	with buzzer	anthracite / metallic silver	220 x 160 x 47



two note, electromechanical system

1.) connection: direct to mains 220-240V AC, 220/127V AC

2.) connection: mains 230 V AC through built-in Bell-transformer 8V, 1A

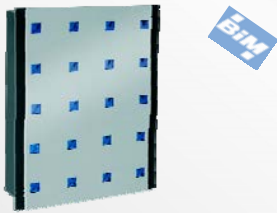

Art. No.	Power	Colour	Size mm
412 AN/BL 240	220-240 V	anthracite / metallic silver blue	220 x 160 x 47
412 AN/BL BIV	220/127 V	anthracite / metallic silver blue	220 x 160 x 47
412 TR AN/BL	with trafo	anthracite / metallic silver blue	220 x 160 x 47
412 SU AN/BL	with buzzer	anthracite / metallic silver blue	220 x 160 x 47

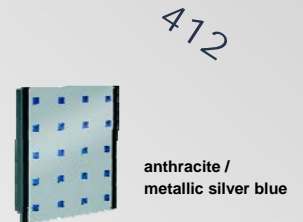

two note, electromechanical system

1.) connection: direct to mains 220-240V AC, 220/127V AC

2.) connection: mains 230 V AC through built-in Bell-transformer 8V, 1A



Art. No.	Power	Colour	Size mm
105 WE/GO 240	220-240 V	white / gold	190 x 145 x 45
105 WE/GO BIV	220/127 V	white / gold	190 x 145 x 45
105 TR WE/GO	with trafo	white / gold	190 x 145 x 45



two note, electromechanical system

1.) connection: direct to mains 220-240V AC, 220/127V AC

2.) connection: mains 230 V AC through built-in Bell-transformer 8V, 1A



Art. No.	Power	Colour	Size mm
500 WE 240	220-240 V	white	150 x 150 x 45
500 GE 240	220-240 V	pastel yellow	150 x 150 x 45
500 BL 240	220-240 V	pale blue	150 x 150 x 45
500 WE BIV	220/127 V	white	150 x 150 x 45
500 GE BIV	220/127 V	pastel yellow	150 x 150 x 45
500 BL BIV	220/127 V	pale blue	150 x 150 x 45

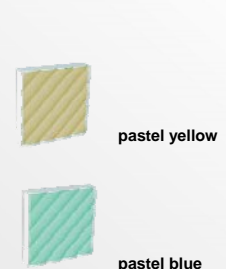

two note, electromechanical system

connection: direct to mains  
220-240V AC, 220/127V AC

## Door Chimes



grey / blue

two note, electromechanical system  
connection: direct to mains  
220-240V AC, 220/127V AC

Art. No.	Power	Colour	Size mm
707 GR/BL 240	220-240 V	grey / blue	210 x 210 x 55
707 GR/GN 240	220-240 V	grey / green	210 x 210 x 55
707 GR/GE 240	220-240 V	grey / yellow	210 x 210 x 55
707 GR/BL BIV	220/127 V	grey / blue	210 x 210 x 55
707 GR/GN BIV	220/127 V	grey / green	210 x 210 x 55
707 GR/GE BIV	220/127 V	grey / yellow	210 x 210 x 55



grey / green



grey / yellow

707



two note, electromechanical system  
connection: direct to mains  
220-240V AC, 220/127V AC

Art. No.	Power	Colour	Size mm
708 GR 240	220-240 V	grey / silber	210 x 210 x 55
708 GR BIV	220/127 V	grey / silber	210 x 210 x 55



grey / silber

708



two note, electromechanical system  
connection: direct to mains  
220-240V AC, 220/127V AC

Art. No.	Power	Colour	Size mm
709 GR 240	220-240 V	grey / chrome	210 x 210 x 55
709 GR BIV	220/127 V	grey / chrome	210 x 210 x 55



grey / chrome

709



surface type  
220-240 V AC, 70 mm dia. flat gong with connection  
for additional door bell or door opener.

### Bell combined with bell transformer

Art. No.	Power	Execution	Size mm
2553 WE 230	220-240 V AC	with bell	137 x 80 x 38
2555 WE 230	220-240 V AC	with buzzer	137 x 80 x 38



white

2553

2555

### School Bells



Art. No.	Power	Colour	Diameter
56-GR	12 V AC	grey	154 mm
56-GR	220-240 V AC	grey	154 mm
66-RT	12 V DC	red	154 mm
66-RT	240V DC	red	154 mm
59-GR	24 V AC	grey	230 mm
59-GR	220-240 V AC	grey	230 mm



grey



red

56

## Door Entry Accessories

### Wireless Door Bells

- 17 appealing polyphone melodies
- ALARM function with DIN emergency call tone
- incl. water-proof combination transmitter IP 54
- central and individual paging available
- volume adjustable

Art. No.	Wireless Range	Volume	Transmission Frequency	Receiver Measurements
MISTRAL 200 / 43305	250 m	86 dB(A)	868.35 MHz	150 x 115 x 38 mm
MISTRAL 600 / 43400	500 m	83 dB(A)	868.35 MHz	180 x 140 x 50 mm



SET MISTRAL 200



SET MISTRAL 600



Incl. 12 glossy motif cover and high quality acrylic sheet for real glass look



### Video Analog Door Entry Kit surface mounting street panel, hands free



SET  
3 690 83



Colour 7" screen analog video kit -  
Hands free - 4 wires (+ 2 to open the gate)

The monitor allows surveillance and opening of the gate.  
The system allows 2 additional monitors, with intercom function.

#### Composition:

- 1 metal street panel (entrance) with LED lights
- 1 colour 7" monitor. Equipped with cable and plug.
- 1 wall-mounting base
- 1 set of screws for fixing on walls

Art. No. (BS-Plug)	Art. No. (Schuko-Plug)	Power
3 690 83	3 690 80	Complete Video Kit
3 690 88	3 690 85	Additional video internal kit

### Electric Door Openers



10 K



14 / D11



17 / D11

classic model - surface mounted

- suitable for all common striking plates
- due to 180° fitting, can be used DIN right and left
- symmetrical design

Art. No.	Power	Size
10 K / 6-12	6 - 12 V	132 x 65 x 24 mm
10 K / 24	24 V	(coverplate: 132 x 65 mm)
14 / D11	6 - 12 V	90 x 20 x 28,2 mm
17 / D11	6 - 12 V	75 x 20,5 x 28 mm

## Condor Float Switches



### PN-X

10 (8) A 250 V - IP 68  
with rubber cable (H07RN-F 3G1,0 sqmm)



### PN-X

Float switches for filling and emptying.



full + empty

Art. No.	Cable length	Pieces / carton	Pieces / pallet
PN-X-1,5	1,5 mtr	100 pcs	800 pcs
PN-X-3,0	3,0 mtr	80 pcs	640 pcs
PN-X-5,0	5,0 mtr	60 pcs	480 pcs
PN-X-10,0	10,0 mtr	40 pcs	320 pcs

### PSN-X / F / O

10 (8) A 250 V - IP 68  
with rubber cable (H07RN-F 3G1,0 sqmm)



### PSN-X

Float switches for filling and emptying.

### PSN-F

Float switches for filling. On reaching the lower switching threshold, the switching mechanism activates the pump. On reaching the upper switching threshold the pump is switched off.

### PSN-O

Float switches for emptying. On reaching the upper switching threshold the switching mechanism activates the pump. On reaching the lower switching

full + empty

full

empty

Art. No.	Cable length	Packing	Art. No.	Cable length	Packing	Art. No.	Cable length	Packing
PSN-X-1,5	1,5 mtr	100 pcs	PSN-F-1,5	1,5 mtr	100 pcs	PSN-O-1,5	1,5 mtr	100 pcs
PSN-X-3,0	3,0 mtr	80 pcs	PSN-F-3,0	3,0 mtr	80 pcs	PSN-O-3,0	3,0 mtr	80 pcs
PSN-X-5,0	5,0 mtr	60 pcs	PSN-F-5,0	5,0 mtr	60 pcs	PSN-O-5,0	5,0 mtr	60 pcs
PSN-X-10,0	10,0 mtr	40 pcs	PSN-F-10,0	10,0 mtr	40 pcs	PSN-O-10,0	10,0 mtr	40 pcs

## Accessories



IG - PS



BS - PS

Weight for float switch, for free setting of the switching differences

Art. No.	Weight
IG - PS	180 g
BS - PS	400 g



## Float Switches

As one of the Middle East's favourite float switches, the EGK PN/BG resp. RS provide a very simple and reliable solution for the handling of water tanks in domestic and light industrial applications.



**KISTENMACHER Float Switch**  
16A/250V, pumping full and empty,  
PVC cable,  
including counter weight  
single-packed in a strong plastic bag

Suitable for pumps of up to 2 HP (230V) / 1 HP (110V)

Electrical features:  
Microswitch: 250V~  
Rated current: 16(8)A  
Max. operational temperature: 50°C  
Storage temperature: -10°C to + 60°C  
Protection grade: IP68

Item-No.	Cable	pcs. / carton	pcs. / pallet
EGK PN-BG/1,5mtr.	1,5 mtr. x 1,00 sqmm	20 pcs.	320 pcs.
EGK PN-BG/2mtr.	2,0 mtr. x 1,00 sqmm	20 pcs.	320 pcs.
EGK PN-BG/3mtr.	3,0 mtr. x 1,00 sqmm	20 pcs.	320 pcs.
EGK PN-BG/5mtr.	5,0 mtr. x 1,00 sqmm	15 pcs.	240 pcs.
EGK PN-BG/10mtr.	10,0 mtr. x 1,00 sqmm	10 pcs.	160 pcs.



**KISTENMACHER Float Switch**  
16A/250V, pumping full and empty,  
PVC cable,  
including counter weight  
single-packed in a strong cardboard box

Suitable for pumps of up to 2 HP (230V) / 1 HP (110V)

Electrical features:  
Microswitch: 250V~  
Rated current: 16(8)A  
Max. operational temperature: 50°C  
Storage temperature: -10°C to + 60°C  
Protection grade: IP68

Item-No.	Cable	pcs. / carton	pcs. / pallet
EGK PN-RS/1,5mtr.	1,5 mtr. x 1,00 sqmm	24 pcs.	432 pcs.
EGK PN-RS/2mtr.	2,0 mtr. x 1,00 sqmm	24 pcs.	432 pcs.
EGK PN-RS/3mtr.	3,0 mtr. x 1,00 sqmm	24 pcs.	432 pcs.
EGK PN-RS/5mtr.	5,0 mtr. x 1,00 sqmm	12 pcs.	216 pcs.
EGK PN-RS/10mtr.	10,0 mtr. x 1,50 sqmm	12 pcs.	216 pcs.

## Plastic Plugs, Couplings and Adaptors



### Schuko Plug

Plug

Art. No.	Volt / Amp	Colour
614S	250 V / 16 A	Black
614W	250 V / 16 A	White



### Schuko Coupling

Coupling

Art. No.	Volt / Amp	Colour
544S	250 V / 16 A	Black
544W	250 V / 16 A	White



### Adapter Plug

from American flat pins to Schuko

Art. No.	Volt / Amp	Colour
686 sw	250 V / 10 A	Black
686 ws	250 V / 10 A	White



### Adapter Plug

from Schuko to American flat pins

Art. No.	Volt / Amp	Colour
695 sw	250 V / 10 A	Black
695 ws	250 V / 10 A	White



### Iron Plug

- rewirable with earthing contact and strain relief sleeve
- without switch

Art. No.	Volt / Amp	Colour
685 sw	250 V / 10 A	Black
685 ws	250 V / 10 A	White

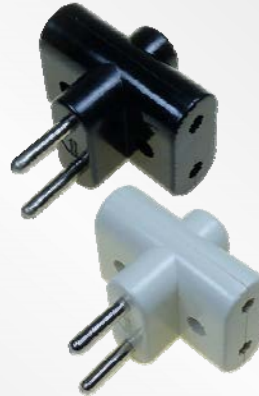

### Three Way Plugs

6 A, with solid slotted pins

Art. No.	Volt / Amp	Colour
671 sw	250 V / 6 A	Black
671 ws	250 V / 6 A	White



### Adapter Plug

from British Standard to Schuko

Art. No.	Volt / Amp	Colour
146 sw	250 V / 13 A	Black
146 ws	250 V / 13 A	White



from Schuko to British Standard

Art. No.	Volt / Amp	Colour
148 sw	250 V / 13 A	Black
148 ws	250 V / 13 A	White



### BS-Plug with earthing contact

available with or without strain reliefe sleeve

Art. No.	Volt / Amp	Colour
523 sw	250 V / 13 A	Black
523 ws	250 V / 13 A	White



Art. No.	Volt / Amp	Colour
0 503 26	250 V / 13 A	White

with ASTA Certification

## KISTENMACHER Rubber Plugs and



10-16 A / 250 Volt



Long  
Version

Plug

Art. No.	Colour	Packing / Carton
31501	Black	20 pieces



Coupling

Art. No.	Colour	Packing / Carton
31701	Black	15 pieces

10-16 A / 250 Volt



Short  
Version

Plug

Art. No.	Colour	Packing / Carton
31511	Black	25 pieces



Coupling

Art. No.	Colour	Packing / Carton
31791	Black	20 pieces

## KISTENMACHER Rubber Plugs and



16 A / 250 Volt



Plug

Art. No.	Colour	Packing / Carton
12091	Black	40 pieces



Coupling

Art. No.	Colour	Packing / Carton
12151	Black	20 pieces

## Rubber Plugs and Couplings - Schuko

PCE



16 A / 250 Volt  
IP 44 - splashproof

Plug

Art. No.	Colour	Packing / Carton
0511-S	Black	30 pieces



IP 20

Coupling

Art. No.	Colour	Packing / Carton
2510-S	Black	20 pieces



## Weatherproof Isolating Switches

**KISTENMACHER** offers two different styles of isolating switches for the highest demands in rough environments. Our new S-Series isolating switches are suitable for current ratings of up to 100A.

### Isolating Switches:

**Voltage:** max. 440V  
**Protection:** IP 66  
**Measurements:** 80 x 80 x 160 mm  
**Cable entries:** 4 (2 ea. at top / bottom)



Art.-No.	Poles	Current	pcs. / carton	ctns. / pallet
EGK 1p.-20A	1-pole	20A	24 pcs.	16 cartons
EGK 1p.-35A	1-pole	35A	24 pcs.	16 cartons
EGK 1p.-63A	1-pole	63A	24 pcs.	16 cartons
EGK 2p.-20A	2-pole	20A	24 pcs.	16 cartons
EGK 2p.-35A	2-pole	35A	24 pcs.	16 cartons
EGK 2p.-63A	2-pole	63A	24 pcs.	16 cartons
EGK 3p.-20A	3-pole	20A	24 pcs.	16 cartons
EGK 3p.-35A	3-pole	35A	24 pcs.	16 cartons
EGK 3p.-63A	3-pole	63A	24 pcs.	16 cartons
EGK 4p.-20A	4-pole	20A	24 pcs.	16 cartons
EGK 4p.-35A	4-pole	35A	24 pcs.	16 cartons
EGK 4p.-63A	4-pole	63A	24 pcs.	16 cartons

### Isolating Switches:

Surface-mounted, IP65  
 230-440V

Current (A)	Model		Dimensions (mm)					
	3-pole	4-pole	a	b	c	d	e	f
10A	EGK S0-310	EGK S0-410	80	101	66	35	60	60
16A	EGK S0-316	EGK S0-416						
20A	EGK S0-320	EGK S0-420						
20A	EGK S1-320	EGK S1-420	101	126	86	35	80	115
25A	EGK S1-325	EGK S1-425						
32A	EGK S1-332	EGK S1-432						
32A	EGK S3-332	EGK S3-432	116	176	101	35	90	165
40A	EGK S3-340	EGK S3-440						
50A	EGK S3-350	EGK S3-450						
63A	EGK S3-363	EGK S3-463						
63A	EGK S5-363	EGK S5-463	160	240	122	37	142	193
80A	EGK S5-380	EGK S5-480						
100A	EGK S5-3100	EGK S5-4100						



## Weatherproof Switches / Sockets

**KISTENMACHER** offers a comprehensive range of weatherproof switches and sockets in British standard, German standard as well as multi-standard solutions.

### EGK SMulti

Multi Standard Socket  
Surface-Mounted, IP55  
15A - 250V~

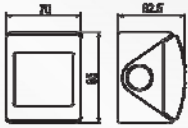

### EGK 1GS

1-Gang Switch / Single Pole  
Surface-Mounted, IP55  
13A - 250V~

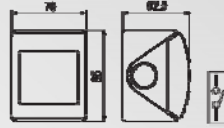

### EGK SSMulti

Multi Standard Switch / Socket  
(1-Gang / Single Pole)  
Surface-Mounted, IP55  
15A - 250V~

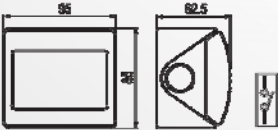

### EGK 2GS

2-Gang Switch / Single Pole  
Surface-Mounted, IP55  
13A - 250V~

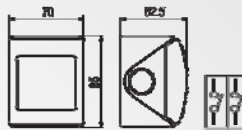

### EGK BSSMulti

Multi Standard Switch / Socket  
(1-Gang / Double Pole)  
Surface-Mounted, IP55  
15A - 250V~

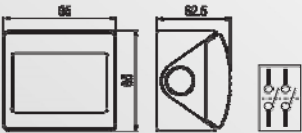

### EGK 3GS

3-Gang Switch / Single Pole  
Surface-Mounted, IP55  
13A - 250V~

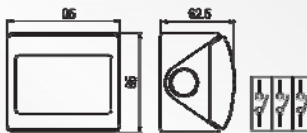

### EGK 2GSSMulti

Multi Standard Switch / Socket  
(2-Gang / Single Pole)  
Surface-Mounted, IP55  
15A - 250V~

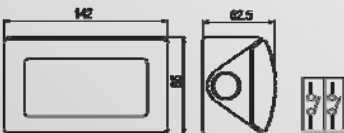

### EGK 4GS

4-Gang Switch / Single Pole  
Surface-Mounted, IP55  
13A - 250V~

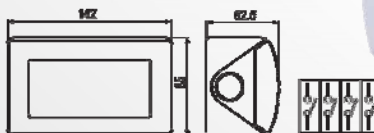

### EGK S/2Multi

Multi Standard Double Socket  
Surface-Mounted, IP55  
15A - 250V~

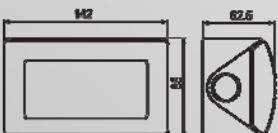

### EGK S/2

BS Standard Double Socket  
Surface-Mounted, IP55  
13A - 250V~

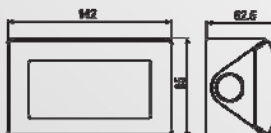

## Weatherproof Switches / Sockets

**KISTENMACHER** offers a comprehensive range of weatherproof switches and sockets in British standard, German standard as well as multi-standard solutions.

### EGK SR

BS Standard (old) Socket  
Surface-Mounted, IP55  
15A - 250V~

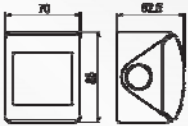

### EGK SSR

BS Standard (old) Switched Socket  
(Boiler Switch)  
Surface-Mounted, IP55  
15A - 250V~



### EGK S

BS Standard Socket  
Surface-Mounted, IP55  
13A - 250V~

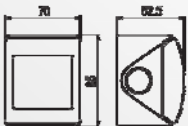

### EGK SS

BS Standard Switch / Socket  
(1-Gang / Single Pole)  
Surface-Mounted, IP55  
13A - 250V~

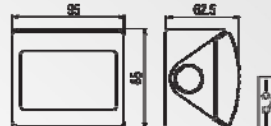

### EGK BSS

BS Standard Switch / Socket  
(1-Gang / Double-Pole)  
Surface-Mounted, IP55  
13A - 250V~

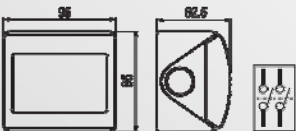

### EGK 2GSS

BS Standard Switch / Socket  
(2-Gang / Single Pole)  
Surface-Mounted, IP55  
13A - 250V~

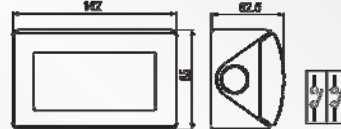

### EGK 1GS2W

1-Gang / 2-Way Switch  
Surface-Mounted, IP55  
13A - 250V~

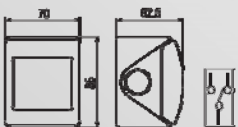

### EGK 1GBS

1-Gang / Double Pole Switch  
Surface-Mounted, IP55  
13A - 250V~

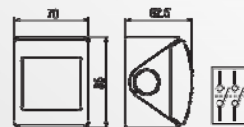

### EGK 2GS2W

2-Gang / 2-Way Switch  
Surface-Mounted, IP55  
13A - 250V~

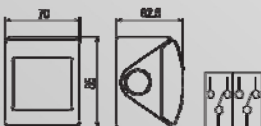

### EGK 2GBS

2-Gang / Double Pole Switch  
Surface-Mounted, IP55  
13A - 250V~

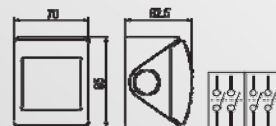

## Weatherproof Switches / Sockets

**KISTENMACHER** offers a comprehensive range of weatherproof switches and sockets in British standard, German standard as well as multi-standard solutions.

### EGK 3GS2W

3-Gang / 2-Way Switch  
Surface-Mounted, IP55  
13A - 250V~

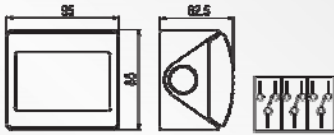

### EGK 3GBS

3-Gang / Double Pole Switch  
Surface-Mounted, IP55  
13A - 250V~

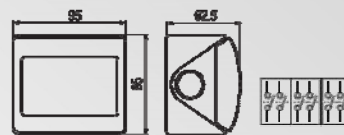

### EGK 4GS2W

4-Gang / 2-Way Switch  
Surface-Mounted, IP55  
13A - 250V~

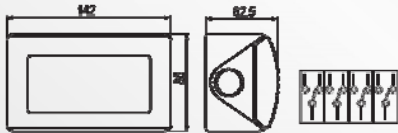

### EGK 4GBS

4-Gang / Double Pole Switch  
Surface-Mounted, IP55  
13A - 250V~

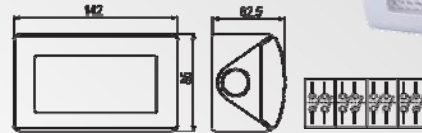

### EGK 1GB

Bell Switch  
Surface-Mounted, IP55  
16A - 250V~

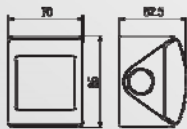

### EGK TS

Schuko Standard Socket  
Surface-Mounted, IP55  
16A - 250V~

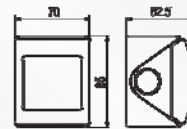

### EGK TSS

Schuko Standard Switch / Socket  
(1-Gang / Single Pole)  
Surface-Mounted, IP55  
16A - 250V~

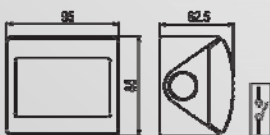

### EGK SR/2

Schuko Standard Double Socket  
Surface-Mounted, IP55  
16A - 250V~

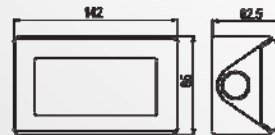

### EGK T2GSS

Schuko Standard Double Switch / Socket  
(2-Gang / Single Pole)  
Surface-Mounted, IP55  
16A - 250V~

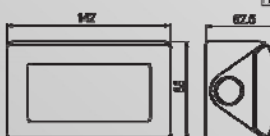

## Waterproof Material AQUA TOP-Serie



455009 - single type

### Industrial Socket Outlet

- casing and cover grey
- for 2 cable entries

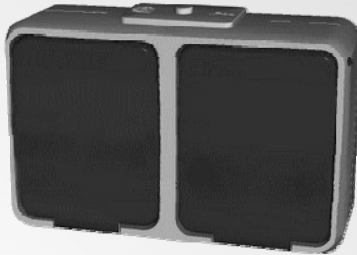

455409 - double type

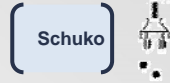

Art. No.	Volt / A	IP	Pieces / Carton
455009	250 V / 10/16 A	IP 44	10 pieces
455409	250 V / 10/16 A	IP 44	5 pieces



451609 - single type

### Industrial ON/OFF-Switch

- casing and rockers grey
- for 2 cable entries



451509 - 2-gang type

Art. No.	Volt / A	IP	Pieces / Carton
451609	250 V / 10 A	IP 44	10 pieces
451509	250 V / 10 A	IP 44	10 pieces

## Waterproof Material PLEXO-Serie



0697 32 - single type

### Socket Outlets

- captive terminals screws supplied in backed off position



0697 39 - 2-gang type



### PLEXO Serie

#### IP 55 weatherproof wiring accessories

Polycarbonate mechanism / ABS frames polypropylene housing

Temp. Rating: - 20 to + 40°C (+ 50°C for short periods)

Supplied with direct piercing gland

Art. No.	Volt / A	IP	Pieces / Carton
0697 32	250 V / 13 A	IP 55	10 pieces
0697 39	250 V / 13 A	IP 55	5 pieces



0697 11 - Two-way switch

### Switches

- supplied with screwless terminals

Art. No.	Volt / A	IP	Pieces / Carton
0697 11	250 V / 10 A	IP 55	10 pieces
0697 15	250 V / 10 A	IP 55	10 pieces



0697 15 - Two-gang two-way switch

### PUSH-Button

Art. No.	Volt / A	IP	Pieces / Carton
0697 20	250 V / 10 A	IP 55	10 pieces





## KISTENMACHER PVC Connectors



Poles: 12 brass terminals, flexible  
 Material: Polyethylen (PE)  
 Terminal: Temperature-stable up to 85°C  
 Bolts: Brass  
 Screws: Steel galvanised, blue chromalised  
 Colours: Natural or Black

Art. No.	Size	Amp.	Pieces / carton
7-1025N	2,5 mm <sup>2</sup>	2,5 A	300 pieces
7-106N	4-6 mm <sup>2</sup>	5 A	200 pieces
7-110N	10 mm <sup>2</sup>	15 A	200 pieces
7-116N	16 mm <sup>2</sup>	30 A	120 pieces
7-125N	25 mm <sup>2</sup>	50 A	100 pieces



Poles: 12 brass terminals, flexible  
 Material: Polyethylen (PE)  
 Terminal: Temperature-stable up to 85°C  
 Bolts: Nickel plated brass  
 Screws: Zinc-plated steel  
 Colours: Black or White



Art. No.	Size	Amp.	Voltage	Pieces / carton
Z-154SZ/KM	35 mm <sup>2</sup>	100 A	750 V	40 pieces

## Polyamide EURO Connectors for High Temperature

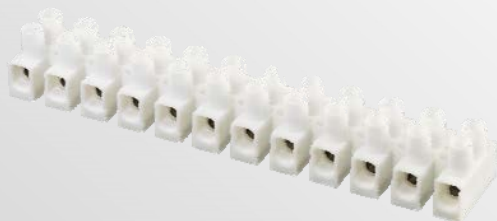

Poles: 12 brass terminals  
 Material: Polyamide (PA), self-extinguishing,  
 Terminal: Temperature-stable up to 100°C  
 Bolts: Brass, nickel plated  
 Screws: Steel galvanised, blue chromalised  
 Colours: Natural, White, Black

acc. to DIN EN 60998 / VDE 0613

Art. No.	Size	Amp.	Pieces / carton
7-1025N PA VDE	2,5 mm <sup>2</sup>	2,5 A	300 pieces
7-104N PA VDE	4 mm <sup>2</sup>	5 A	200 pieces
7-106N PA VDE	6 mm <sup>2</sup>	7,5 A	200 pieces
7-110N PA VDE	10 mm <sup>2</sup>	15 A	200 pieces
7-116N PA VDE	16 mm <sup>2</sup>	30 A	120 pieces

## Porcelain Connectors



Poles: 1 - without fitting hole, no wire protection  
 2 + 3 - with fitting hole, no wire protection

Material: Porcelain KER DIN 40685, white glazed  
 Terminal: Temperature-stable up to max. 350°C  
 Bolts: Brass, nickel plated  
 Screws: steel, galvanised, blue chromalised  
 Packing: 100 pieces / carton

acc. to DIN EN 60998 / VDE 0613

Rated cross section (for solid conductors)	Art. No. 1-poles	Art. No. 2-poles	Art. No. 3-poles	Ampere
2,50 mm <sup>2</sup>	120201	120212	120213	24 A
4 mm <sup>2</sup>	122201	122212	122213	32 A
6 mm <sup>2</sup>	123201	123212	123213	41 A
10 mm <sup>2</sup>	124201	124212	124213	57 A
16 mm <sup>2</sup>	125201	125212	125213	76 A

## Bakelite Connectors



Poles: 12  
 Material: Bakelite type PF31  
 Terminal: Temperature-stable up to max. 140°C  
 Bolts: Brass, nickel plated (galvanised)  
 Screws: Zinc-plated steel (galvanised)  
 Colour: Black

Art. No.	Size	Pieces / carton
3-722-8-12	1,5 - 6 mm <sup>2</sup>	20 pieces
3-822-8-12	10 mm <sup>2</sup>	20 pieces
3-922-8-12	16 mm <sup>2</sup>	20 pieces

## Cable Junction Boxes



with pre-moulded knock-outs  
(for application with cable glands)



Art. No.	Dimensions	Lid closing method	IP	No. of entries	Cable Glands	Cables dia. min./max.	Packing
220-A	80x80x50 mm	Press-On	54	7	PG16	11-14	10 pieces
222-A	100x100x55 mm	Twist-Lock Screws	65	6	PG16	11-14	6 pieces
221-A	150x110x70 mm	Twist-Lock Screws	65	10	PG16	11-14	3 pieces
223-A	175x110x66 mm	Twist-Lock Screws	65	10	PG16	11-14	3 pieces
223-ATA	175x110x83 mm	Twist-Lock Screws	65	10	PG16	11-14	3 pieces
225-A	190x150x70 mm	Twist-Lock Screws	65	10	2 PG29+8PG21	14-25	3 pieces
225-ATA	190x150x83 mm	Twist-Lock Screws	65	10	2 PG29+8PG21	14-25	3 pieces
224-A	220x170x120 mm	Twist-Lock Screws	65	10	2 PG29+8PG21	14-25	2 pieces

with stepped rubber grommets



Art. No.	Dimensions	Lid closing method	IP	No. of entries	Cable Glands	Cables dia. min./max.	Packing
219-B	80x45 mm	Press-On	54	4	PG21	3,5-23,5	8 pieces
220-B	80x80x50 mm	Press-On	54	7	PG16	3,5-20	10 pieces
222-B	100x100x55 mm	Twist-Lock Screws	65	6	PG21	3,5-23,5	6 pieces
221-B	150x110x70 mm	Twist-Lock Screws	65	10	PG21	3,5-23,5	3 pieces
223-B	175x110x66 mm	Twist-Lock Screws	65	10	PG21	3,5-23,5	3 pieces
223-BTA	175x110x83 mm	Twist-Lock Screws	65	10	PG21	3,5-23,5	3 pieces
225-B	190x150x70 mm	Twist-Lock Screws	65	10	2 PG29+8PG21	3,5-32	3 pieces
225-BTA	190x150x83 mm	Twist-Lock Screws	65	10	2 PG29+8PG21	3,5-32	3 pieces
224-B	220x170x120 mm	Twist-Lock Screws	65	10	2 PG29+8PG21	3,5-32	2 pieces

with plain walls



Art. No.	Dimensions	Lid closing method	IP	No. of entries	Cable Glands	Cables dia. min./max.	Packing
220-L	80x80x50 mm	Press-On	54	X	X	X	10 pieces
222-L	100x100x55 mm	Twist-Lock Screws	65	X	X	X	6 pieces
221-L	150x110x70 mm	Twist-Lock Screws	65	X	X	X	3 pieces
223-L	175x110x66 mm	Twist-Lock Screws	65	X	X	X	3 pieces
223-LTA	175x110x83 mm	Twist-Lock Screws	65	X	X	X	3 pieces
225-L	190x150x70 mm	Twist-Lock Screws	65	X	X	X	3 pieces
225-LTA	190x150x83 mm	Twist-Lock Screws	65	X	X	X	3 pieces
224-L	220x170x120 mm	Twist-Lock Screws	65	X	X	X	2 pieces

with transparent covers



Art. No.	Dimensions	Lid closing method	IP	No. of entries	Cable Glands	Cables dia. min./max.	Packing
221-ATR	150x110x70 mm	Twist-Lock Screws	65	10	PG16	11-14	3 pieces
221-BTR	150x110x70 mm	Twist-Lock Screws	54	10	PG21	3,5-23,5	3 pieces
221-LTR	150x110x70 mm	Twist-Lock Screws	65	X	X	X	3 pieces
223-ATR	175x110x66 mm	Twist-Lock Screws	65	10	PG21	11-14	3 pieces
223-BTR	175x110x66 mm	Twist-Lock Screws	54	10	PG21	3,5-23,5	3 pieces
223-LTR	175x110x66 mm	Twist-Lock Screws	65	X	X	X	3 pieces
223-ATATR	175x110x83 mm	Twist-Lock Screws	65	10	PG16	11-14	3 pieces
223-BTATR	175x110x83 mm	Twist-Lock Screws	54	10	PG21	3,5-23,5	3 pieces
223-LTATR	175x110x83 mm	Twist-Lock Screws	65	X	X	X	3 pieces
225-ATR	190x150x70 mm	Twist-Lock Screws	65	10	2 PG29+8PG21	14-45	3 pieces
225-BTR	190x150x70 mm	Twist-Lock Screws	54	10	2 PG29+8PG21	3,5-32	3 pieces
225-LTR	190x150x70 mm	Twist-Lock Screws	65	10	X	X	3 pieces
225-ATATR	190x150x83 mm	Twist-Lock Screws	65	10	2 PG29+8PG21	14-25	3 pieces
225-BTATR	190x150x83 mm	Twist-Lock Screws	54	10	2 PG29+8PG21	3,5-32	3 pieces
225-LTATR	190x150x83 mm	Twist-Lock Screws	65	X	X	X	3 pieces
224-ATR	220x170x120 mm	Twist-Lock Screws	65	10	2 PG29+8PG21	14-25	2 pieces
224-BTR	220x170x120 mm	Twist-Lock Screws	65	10	2 PG29+8PG21	3,5-32	2 pieces



### Junction Box i 12-L

complete with perforation tool and blanking plug, with external fixing positions according to DIN EN 60670 (VDE 0606), 12 entries, 3 floor entries, IP 55, grey, without terminals, for VDE approved single terminals

Base made of Polyethylene, Cover made of Polypropylene

Art. No.	Size	Cross Section	Insulation Voltage AC	Blanking Plug
332 912 01	85 x 85 x 37 mm	2,5 mm <sup>2</sup>	400 V	M 16



### Junction Box - WK Range

Duroplastic, halogen-free, with IP54 attachment bushes, grey, without terminals, acc. DIN EN 60670 (VDE 0606)

Art. No. / WK	Size	Cross section	Insulation voltage AC	Blanking Plug	Seal Range	With sealing kit
402 907 01 / WK 007	80 x 80 x 38 mm	2,5 mm <sup>2</sup>	400 V	M 16	6 - 10 mm	No
404 907 01 / WK 040	87 x 87 x 45 mm	4 mm <sup>2</sup>	690 V	M 20	8 - 13,5 mm	No
406 906 01 / WK 060	100 x 100 x 50 mm	6 mm <sup>2</sup>	690 V	M 25	9 - 18,5 mm	No
410 906 01 / WK 100	115 x 115 x 66 mm	10 mm <sup>2</sup>	690 V	M 32	13 - 23 mm	Yes
416 912 01 / WK 160	165 x 165 x 76 mm	16 mm <sup>2</sup>	690 V	M 40	17 - 30 mm	Yes
425 916 01 / WK 250	256 x 171 x 106 mm	25 mm <sup>2</sup>	690 V	M 40	17 - 30 mm	Yes



### Distribution Box - AKi Range

Industrial quality, halogen-free, IP 65, PE/N terminal, masking and labelling strips, insulating seals, additional double-membrane seals

Art. No. / Aki	Size	Insulation Voltage AC	Modules	Pole	Elastic entries on top
736 403 01 / Aki 03	100 x 150 x 96 mm	400 V	3	2 x 4 pole 6/16mm <sup>2</sup>	3
736 405 01 / Aki 05	125 x 200 x 122 mm	400 V	5	2 x 5 pole 6/16mm <sup>2</sup>	4
736 409 01 / Aki 09	200 x 200 x 122 mm	400 V	9	2 x 7 pole 6/16mm <sup>2</sup>	6
736 412 01 / Aki 12	250 x 200 x 122 mm	400 V	12	2 x 12 pole 6/16mm <sup>2</sup>	8
736 424 01 / Aki 24	250 x 370 x 122 mm	400 V	24	2 x 16 pole 6/16mm <sup>2</sup>	8



## Cable Glands



### CONUS Cable Gland

Material: Polystyrene, impact-proof, halogen-free, grey, IP 54, PG connection thread

also available with adjustable rubbering (IP65) (Art.No. +...AS)

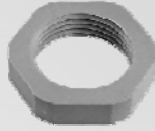

### Locknut

Material: Polystyrene, impact-proof, halogen-free, grey, PG connection thread



### Screw Plug

Material: Polystyrene, impact-proof, halogen-free, grey, IP 54, PG connection thread



Art. No.	Size	Packing Unit
250/07	3,5 - 6	50
250/09	4,5 - 7	50
250/11	6 - 9	50
250/13	9 - 12	50
250/16	11 - 14	50
250/21	14 - 18	50
250/29	18 - 25	10
250/36	25 - 32	10
250/42	30 - 38	5
250/48	34 - 42	5

Art. No.	Packing Unit
3420/07	100
3420/09	100
3420/11	100
3420/13	100
3420/16	100
3420/21	100
3420/29	50
3420/36	25
3420/42	25
3420/48	25

Art. No.	Packing Unit
514/07	100
514/09	100
514/11	100
514/13	100
514/16	100
514/21	100
514/29	50
514/36	25
514/42	25
514/48	25



### Cable Gland

Material: brass, nickel plated IP 54, PG connection thread

also available with adjustable rubber ring (IP65) (Art.No. +...A)



### Locknut

Material: brass, nickel plated, PG connection thread



### Screw Plug

Material: brass, nickel plated, PG connection thread



Art. No.	Size	Packing Unit
530/07	5 - 7	100
530/09	6 - 8	100
530/11	8 - 10	50
530/13	11 - 13	50
530/16	13 - 15	50
530/21	17 - 19	25
530/29	24 - 26	10
530/36	31 - 33	10
530/42	37 - 39	10
530/48	41 - 43	5

Art. No.	Packing Unit
420/07	100
420/09	100
420/11	100
420/13	100
420/16	100
420/21	100
420/29	100
420/36	50
420/42	25
420/48	25

Art. No.	Packing Unit
1514/07	100
1514/09	100
1514/11	100
1514/13	100
1514/16	100
1514/21	100
1514/29	50
1514/36	25
1514/42	25
1514/48	25



### IPON Cable Glands light grey

with integrated strain relief, Material: Polyamide, halogen-free, IP68, 5 Bar, light grey  
Flame-retardance: UL94V-0  
Glow wire test: 850°C

PG or metric ISO thread available

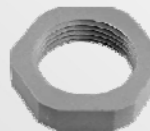

### Locknut

Material: Polyamide, glass-fibre reinforced, with fire protection, halogen-free

PG or metric ISO thread available



### Screw Plug

Material: Polyamide, impact-proof, halogen-free, IP54

PG or metric ISO thread available

Art. No.	Size	Packing Unit
1234P0701	3 - 6,5	50
1234P0901	4 - 8	50
1234P1101	5 - 10	50
1234P1301	6 - 12	50
1234P1601	9 - 14	50
1234P2101	12 - 18	25
1234P2901	17 - 25	10
1234P3601	20 - 32	10
1234P4201	32 - 38	5
1234P4801	37 - 44	5

Art. No.	Packing Unit
1420/07	100
1420/09	100
1420/11	100
1420/13	100
1420/16	100
1420/21	100
1420/29	100
1420/36	50
1420/42	25
1420/48	25

Art. No.	Packing Unit
514/07	100
514/09	100
541/11	100
541/13	100
514/16	100
514/21	100
514/29	50
514/36	25
514/42	25
514/48	25

## Cable Ties

All **KISTENMACHER** Cable Ties are one piece moulded mechanism with no metal barbs or cumbersome wedges, molded of the finest virgin Nylon 66, self-extinguishing UL-94 flam.

Class: V-2, V-0 available upon request.

Bent tip, finger grip tip, low threading force, no sharp edges ensure easy handling and installation to increase productivity and reduce your installation costs.

Standard colors: natural nylon, Pigmented black optional. Other colors available upon request. Ultraviolet ray resistand black ties for outdoor applications and heat stabilized ties available upon request



### Standard:

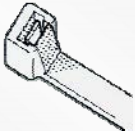

Operating temperature:

- 40°C to + 85° C



Art.-No.	Length mm	Width mm	Pieces / plastic	Pieces / carton
EGK C 080 x 2,5	80 mm	2,5 mm	100 pieces	60.000 pieces
EGK C 100 x 2,5	100 mm	2,5 mm	100 pieces	60.000 pieces
EGK C 120 x 2,5	120 mm	2,5 mm	100 pieces	45.000 pieces
EGK C 150 x 2,5	150 mm	2,5 mm	100 pieces	40.000 pieces
EGK C 200 x 2,5	200 mm	2,5 mm	100 pieces	30.000 pieces
EGK C 150 x 3,5	150 mm	3,5 mm	100 pieces	25.000 pieces
EGK C 180 x 3,5	180 mm	3,5 mm	100 pieces	22.000 pieces
EGK C 200 x 3,5	200 mm	3,5 mm	100 pieces	20.000 pieces
EGK C 250 x 3,5	250 mm	3,5 mm	100 pieces	16.000 pieces
EGK C 300 x 3,5	300 mm	3,5mm	100 pieces	14.000 pieces
EGK C 370 x 3,5	370 mm	3,5 mm	100 pieces	12.000 pieces
EGK C 200 x 4,8	200 mm	4,8 mm	100 pieces	14.000 pieces
EGK C 250 x 4,8	250 mm	4,8 mm	100 pieces	12.000 pieces
EGK C 300 x 4,8	300 mm	4,8 mm	100 pieces	10.000 pieces
EGK C 350 x 4,8	350 mm	4,8 mm	100 pieces	10.000 pieces
EGK C 370 x 4,8	370 mm	4,8 mm	100 pieces	9.000 pieces
EGK C 400 x 4,8	400 mm	4,8 mm	100 pieces	8.000 pieces
EGK C 450 x 4,8	450 mm	4,8 mm	100 pieces	6.000 pieces
EGK C 500 x 4,8	500 mm	4,8 mm	100 pieces	5.000 pieces
EGK C 200 x 7,6	200 mm	7,6 mm	100 pieces	7.000 pieces
EGK C 250 x 7,6	250 mm	7,6 mm	100 pieces	6.000 pieces
EGK C 300 x 7,6	300 mm	7,6 mm	100 pieces	5.000 pieces
EGK C 350 x 7,6	350 mm	7,6 mm	100 pieces	5.000 pieces
EGK C 400 x 7,6	400 mm	7,6 mm	100 pieces	4.000 pieces
EGK C 450 x 7,6	450 mm	7,6 mm	100 pieces	3.500 pieces
EGK C 500 x 7,6	500 mm	7,6 mm	100 pieces	3.000 pieces
EGK C 550 x 7,6	550 mm	7,6 mm	100 pieces	2.000 pieces
EGK C 700 x 7,6	700 mm	7,6 mm	100 pieces	1.000 pieces
EGK C 400 x 9,0	400 mm	9,0 mm	100 pieces	2.000 pieces
EGK C 450 x 9,0	450 mm	9,0 mm	100 pieces	2.000 pieces
EGK C 500 x 9,0	500 mm	9,0 mm	100 pieces	2.000 pieces
EGK C 550 x 9,0	550 mm	9,0 mm	100 pieces	1.000 pieces
EGK C 600 x 9,0	600 mm	9,0 mm	100 pieces	1.000 pieces
EGK C 650 x 9,0	650 mm	9,0 mm	100 pieces	1.000 pieces
EGK C 700 x 9,0	700 mm	9,0 mm	100 pieces	1.000 pieces
EGK C 750 x 9,0	750 mm	9,0 mm	100 pieces	1.000 pieces
EGK C 800 x 9,0	800 mm	9,0 mm	100 pieces	1.000 pieces
EGK C 900 x 9,0	900 mm	9,0 mm	100 pieces	1.000 pieces
EGK C 1020 x 9,0	1020 mm	9,0 mm	100 pieces	1.000 pieces

### Heavy Duty line:

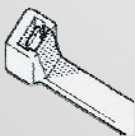

### Heavy Duty line:

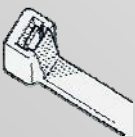

## Spiral Wrapping Band

For the management and protection of cables and hoses, **KISTENMACHER** offers, plastic spiral wrapping.

Thanks to flexible PE material, the spiral wrapping can be installed and removed with ease.

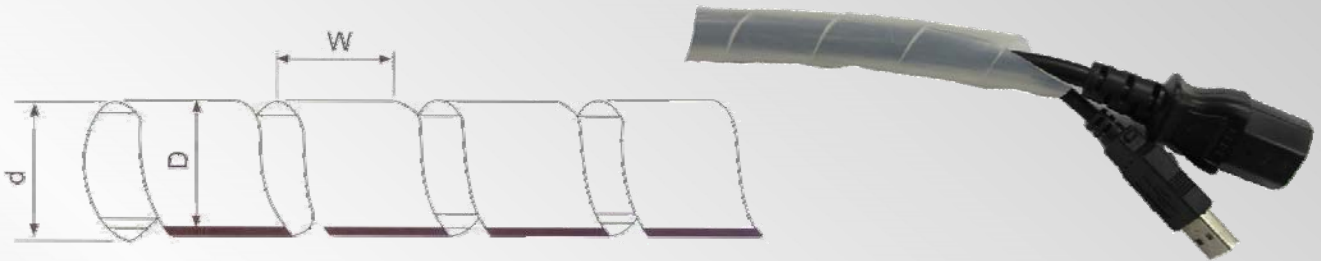

Art.-No.	D (mm)	d (mm)	W (mm)	Wrapping Range (mm)	Meters / Roll	Rolls / Carton
EGK SW 6	4,00	6,00	7,00	4 - 50	10 m	100 rolls
EGK SW 8	6,00	8,00	10,80	6 - 60	10 m	80 rolls
EGK SW 10	7,50	10,00	11,40	7,5 - 60	10 m	50 rolls
EGK SW 12	9,00	12,00	13,90	9 - 65	10 m	40 rolls
EGK SW 15	12,00	15,00	15,00	12 - 75	10 m	25 rolls
EGK SW 19	15,00	19,00	18,20	15 - 100	10 m	9 rolls
EGK SW 24	20,00	24,00	19,60	20 - 130	10 m	8 rolls

Material: Polyethylene (PE)  
 Temp. resistance of material: -50 to 75°C  
 Colours: natural / black





## Cable Markers

**KISTENMACHER** marker tongue spans to fit various cable diameters and retracts to hold wires firmly in position

Maximum service temperature: +85°C

Material: PVC oil and erosion resistant



Art.-No.	Cable Size (sqmm)	Sqmm	Type-Numbering	Type-Lettering	Type-Symbol	Pieces per Roll	Lenth/Roll
EGK EC 0	0,75 sqmm	0,75 sqmm	0 to 9	A to Z or Blank	+, -, /, #, *, ~, ,	1.000 pieces	4,00 mtr
EGK EC 0	0,75 sqmm - 3,0 sqmm	1,0 sqmm	0 to 9	A to Z or Blank	+, -, /, #, *, ~, ,	1.000 pieces	4,00 mtr
EGK EC 0	1,5 sqmm - 3,0 sqmm	1,5 sqmm	0 to 9	A to Z or Blank	+, -, /, #, *, ~, ,	1.000 pieces	4,00 mtr
EGK EC 1	2,6 sqmm - 4,2 sqmm	2,5 sqmm	0 to 9	A to Z or Blank	+, -, /, #, *, ~, ,	1.000 pieces	4,00 mtr
EGK EC 2	3,6 sqmm - 7,4 sqmm	4,0 sqmm	0 to 9	A to Z or Blank	+, -, /, #, *, ~, ,	500 pieces	2,75 mtr
EGK EC 3	5,0 sqmm - 10,0 sqmm	6,0 sqmm	0 to 9	A to Z or Blank	+, -, /, #, *, ~, ,	350 pieces	1,95 mtr
EGK EC 3	8,0 sqmm - 11,9 sqmm	8,0 sqmm	0 to 9	A to Z or Blank	+, -, /, #, *, ~, ,	250 pieces	1,37 mtr
EGK EC 3	10,0 sqmm	10,0 sqmm	0 to 9	A to Z or Blank	+, -, /, #, *, ~, ,	180 pieces	0,99 mtr
EGK EC 3	12,0 sqmm	12,0 sqmm	0 to 9	A to Z or Blank	+, -, /, #, *, ~, ,	160 pieces	0,88 mtr
EGK EC J	3,6 sqmm - 7,2 sqmm	4,0 sqmm	0 to 9	A to Z or Blank	+, -, /, #, *, ~, ,	500 pieces	2,50 mtr

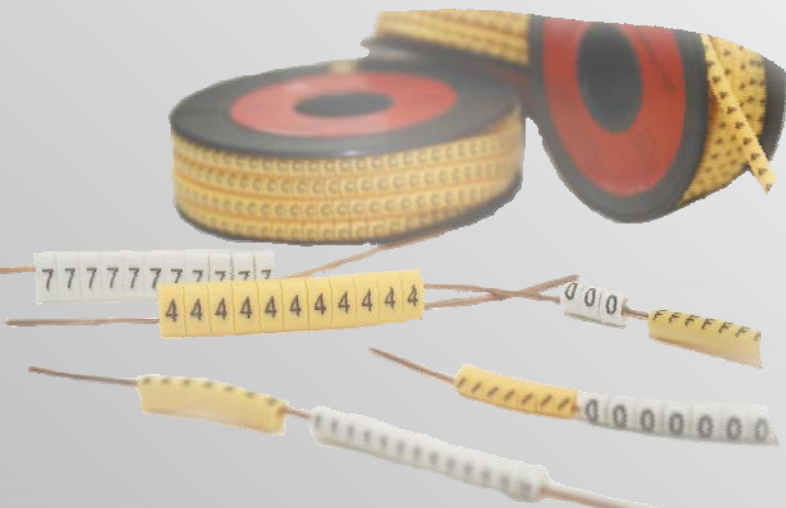



## Pipe Bending Springs

**KISTENMACHER** pipe bending springs are available in a variety of types and will bend electrical conduits with ease.

### Standard Pipe Bending Springs:

one end with plain ending, other end with round hook  
plain steel finishing  
protected by an anti-rust grease film

Art.-No.	Diameter	Length	Pieces/ bag / carton
EGK PBS16	16 mm	560 mm	20 pieces
EGK PBS20	20 mm	560 mm	20 pieces
EGK PBS25	25 mm	560 mm	20 pieces
EGK PBS32	32 mm	560 mm	20 pieces
EGK PBS38	38 mm	560 mm	20 pieces



### Heavy Duty Pipe Bending Springs:

one end with plain ending, other end with **double round hook**  
plain steel finishing  
protected by an anti-rust grease film

Art.-No.	Diameter	Length	Pieces/ bag / carton
EGK PBS-E16	16 mm	560 mm	20 pieces
EGK PBS-E20	20 mm	560 mm	20 pieces
EGK PBS-E25	25 mm	560 mm	20 pieces
EGK PBS-E32	32 mm	560 mm	20 pieces
EGK PBS-E38	38 mm	560 mm	20 pieces



### Galvanized Pipe Bending Springs:

one end with plain ending, other end with round hook  
galvanized steel finishing

Art.-No.	Diameter	Length	Pieces/ bag / carton
EGK PBS-G16	16 mm	560 mm	20 pieces
EGK PBS-G20	20 mm	560 mm	20 pieces
EGK PBS-G25	25 mm	560 mm	20 pieces
EGK PBS-G32	32 mm	560 mm	20 pieces
EGK PBS-G38	38 mm	560 mm	20 pieces

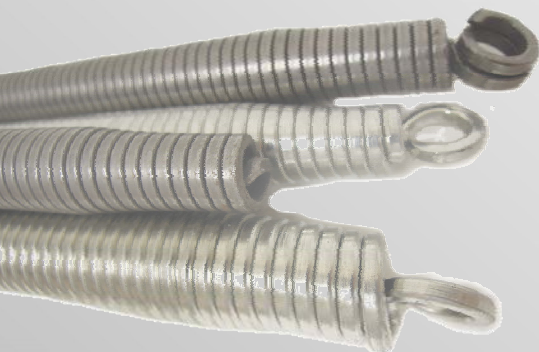



## Draw-In Bands

### KISTENMACHER Plastic Draw-In Bands

Material: Solid Nylon

available in black or white

with revitted eye and ball

Thickness (diameter): 3 mm

Thickness (diameter): 4 mm



Art. No.	Length	Pieces / Carton
PE 305	5 mtr.	400 pcs
PE 310	10 mtr.	200 pcs.
PE 315	15 mtr.	130 pcs.
PE 320	20 mtr.	100 pcs.
PE 325	25 mtr.	80 pcs.
PE 330	30 mtr.	70 pcs.
PE 340	40 mtr.	50 pcs.
PE 350	50 mtr.	40 pcs.

Art. No.	Length	Pieces / Carton
PE 405	5 mtr.	400 pcs.
PE 410	10 mtr.	200 pcs.
PE 415	15 mtr.	100 pcs.
PE 420	20 mtr.	100 pcs.
PE 425	25 mtr.	60 pcs.
PE 430	30 mtr.	50 pcs.

### KISTENMACHER Steel Draw-In Bands

Material: Extra hardened steel

Thickness (diameter): 0,5 mm

Width: 3,5 mm

with revitted eye on both sides

with revitted eye and ball



Art. No.	Length	Pieces / Carton
ST 05	5 mtr.	10 pcs.
ST 10	10 mtr.	10 pcs.
ST 15	15 mtr.	10 pcs.
ST 20	20 mtr.	10 pcs.
ST 25	25 mtr.	10 pcs.
ST 30	30 mtr.	10 pcs.
ST 50	50 mtr.	10 pcs.

Art. No.	Length	Pieces / Carton
STB 05	5 mtr.	10 pcs.
STB 10	10 mtr.	10 pcs.
STB 15	15 mtr.	10 pcs.
STB 20	10 mtr.	10 pcs.
STB 25	25 mtr.	10 pcs.
STB 30	30 mtr.	10 pcs.
STB 50	50 mtr.	10 pcs.

Thickness (diameter): 0,5 mm

Width: 5 mm

with revitted eye on both sides



Art. No.	Length	Pieces / Carton
SB 05	5 mtr.	10 pcs.
SB 10	10 mtr.	10 pcs.
SB 15	15 mtr.	10 pcs.
SB 20	20 mtr.	10 pcs.
SB 25	25 mtr.	10 pcs.
SB 30	30 mtr.	10 pcs..
SB 40	40 mtr.	10 pcs..
SB 50	50 mtr.	5 pcs.



## Splicing Kits



### i-joint cast resin low voltage straight joints (0,6 kV - 1 kV)

The straight joints are suitable for all electrical installation work on all types of plastic cables and those made of PVC, PE, EPR and VPE (e.g. NYY, NYCWY) in the low voltage system.



#### Characteristics

- Two-piece, shock-resistant and transparent moulds
- Compact dimensions
- Preset cable diameter on the moulds
- Ready for use immediately
- Waterproof, both lengthwise and crosswise
- Straight joints castable underwater
- Storable for 36 months

#### Areas of application

- Indoors and Outdoors
- Underground
- Underwater
- In installation channels

according to VDE 278

according to DIN EN 50393

#### Straight joints suitable for all plastic cables (with cast resin PUR 661)

Type	Cable Ø mm (from - to)	Conductor cross-section mm (from - to max.)	Socket dimensions A/B mm	Quantity of resin A/B
KM i-0	7 - 16	3 x 1,5 5 x 2,5	182 / 25	95 ml / 130 g
KM i-1	8 - 24	3 x 1,5 4 x 10 resp. 5 x 6	190 / 36	165 ml / 226 g
KM i-2	14 - 30	5 x 1,5 4 x 25 resp. 5 x 16	276 / 49	400 ml / 548 g
KM i-3	23 - 35	5 x 10 4 x 50 resp. 5 x 35	360 / 54	655 ml / 897 g
KM i-4	28 - 47	4 x 25 4 x 95	400 / 69	1.140 ml / 1.562 g
KM i-5	33 - 55	4 x 50 4 x 150	520 / 100	2 x 1.1450 ml / 1.987 g
KM i-6	48 - 70	4 x 150 4 x 240	700 / 128	4 x 1.640ml / 2.247 g
KM i-7	55 - 77	4 x 185 4 x 400	870 / 140	5 x 1950 ml / 2672 g

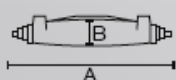

Scope of delivery:  
i-joint, two-component cast resin pouch,  
gloves, adhesive tape, assembly instructions

### Two-component PUR 661 cast resin (low voltage, 0,6 kV - 1 kV)

Suitable for insulation and mechanical protection in the low voltage system.

#### Properties

- In practical transparent two-pocket receptable
- Excellent flow properties
- Highly Hydrophic
- Excellent adhesion to all plastic cables
- Does not crack under electrical stress
- Low exothermic reaction at large-volume

#### Storage time

36 months in aluminium protective bag at surrounding temperatures between 15°C and 35°C

according to DIN VDE 0291 Part 2, GNW, GMW, GFW



Type of resin	ml / g
PUR 661 KM i-0	95 ml / 130 g
PUR 661 KM i-1	165 ml / 226 g
PUR 661 KM i-2	400 ml / 548 g
PUR 661 KM i-3	655 ml / 897 g
PUR 661 KM i-4	1.140 ml / 1.562 g
PUR 661 KM i-5	1.450 ml / 1.987 g
PUR 661 KM i-6	1.640 ml / 2.247 g
PUR 661 KM i-7	1.950 ml / 2.672 g



Properties	Value	Unit
Viscosity	2,0	Pas
Gel time	20	Min
Potlife at 23°C	10	Min
Hardening	1,75	h
Max. reaction temperature	72	°C
Density	1,37	g/cm
Shore - Hardness D	55	Shore D
Tensile strenght	9	N/mm
Elongation at break	115 %	%
Volume shrinkage	≤ 0,54	%
Dielectric dissipation factor at 23°C	0,04	
Dielectric strenght at 23°C	> 20	KV/mm
Volume resistance	2,0 x 10 E14	
Volume resistance	8,0 x 10 E13	
Volume resistance	2,0 x 10 E13	
Tracking resistance	CTI 600	
Water absorbtion (24h/23°C)	47,5	mg
Water absorbtion (42h/50°C)	243	mg
Electrolytic corrosion	A 1,2	
Temperature resistance	-25 up to +120	°C
Shelf life	36	month

## Splicing Kits

### Y-joint

#### cast resin low voltage straight joints (0,6 kV - 1 kV)

The branch joints are suitable for all electrical installation work on all types of plastic cables and those made of PVC, PE, EPR and VPE (e.g. NYY, NYCWY) in the low voltage system.



#### Characteristics

- Two-piece, shock-resistant and transparent moulds
- Compact dimensions
- Preset cable diameter on the moulds
- Ready for use immediately
- Waterproof, both lengthwise and crosswise
- Branch joints castable underwater
- Storable for 36 months

#### Areas of application

- Indoors and Outdoors
- Underground
- Underwater
- In installation channels

according to VDE 278

according to DIN EN 50393

Branch joints suitable for all plastic cables (with cast resin PUR 661)

Type	Cable Ø mm (from - to)	Conductor cross-section mm (to max.)	Socket dimensions A/B mm	Quantity of resin A/B
KM Y-0	main cable: 10 - 24	3 x 1,5 to 4 x 10	190 / 60	240 ml / 329 g
	stub cable: 30° 10 - 24	3 x 1,5 to 4 x 10		
KM Y-1	main cable: 8 - 22	3 x 1,5 to 5 x 10	205 / 70	490 ml / 671 g
	stub cable: 30° 10 - 22	3 x 1,5 to 5 x 6		
KM Y-2	main cable: 25 - 33	4 x 16 to 5 x 25	350 / 98	1.445 ml / 1.980 g
	stub cable: 20° 15 - 30	4 x 6 to 5 x 16		
KM Y-3	main cable: 10 - 40	4 x 16 to 5 x 16	330 / 90	995 ml / 1.308 g
	stub cable: 20° 13 - 28	4 x 10 to 5 x 10		
KM Y-5	main cable: 35 - 51	4 x 25 to 4 x 150	298 / 120	2.045 ml / 2.802 g
	stub cable: 15° 17 - 33	4 x 10 to 4 x 50		
KM Y-6	main cable: 30 - 55	4 x 95 to 4 x 185	430 / 130	2 x 1.450 ml / 1.897 g
	stub cable: 20° 17 - 40	4 x 10 to 4 x 70		

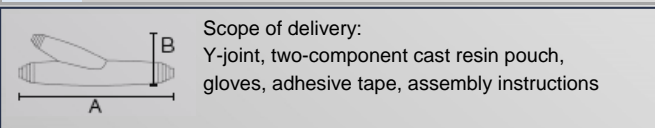

### T-Joint

#### cast resin low voltage branch joints (0,6 kV - 1 kV)

The branch joints are suitable for all electrical installation work on all types of plastic cables and those made of PVC, PE, EPR and VPE (e.g. NYY, NYCWY) in the low voltage system.



#### Characteristics

- Two-piece, shock-resistant and transparent moulds
- Compact dimensions
- Preset cable diameter on the moulds
- Ready for use immediately
- Waterproof, both lengthwise and crosswise
- Branch joints castable underwater
- Storable for 36 months

#### Areas of application

- Indoors and Outdoors
- Underground
- Underwater
- In installation channels

according to VDE 278

according to DIN EN 50393

Branch joints suitable for all plastic cables (with cast resin PUR 661)

Type	Cable Ø mm (from - to)	Conductor cross-section mm (to max.)	Socket dimensions A/B mm	Quantity of resin A/B
KM T-1	main cable: 16 - 26	5 x 1,5 to 5 x 10	276 / 177	455 ml / 623 g
	stub cable: 90° 10 - 24	3 x 1,5 to 5 x 6		
KM T-2	main cable: 25 - 32	5 x 6 to 5 x 16	380 / 225	2.045 ml / 2.802 g
	stub cable: 90° 18 - 25	5 x 1,5 / 5 x 10		
KM T-3	main cable: 29 - 40	5 x 10 to 5 x 50	520 / 205	2 x 1.1450ml / 1.987 g
	stub cable: 90° 20 - 30	5 x 6 to 5 x 16		

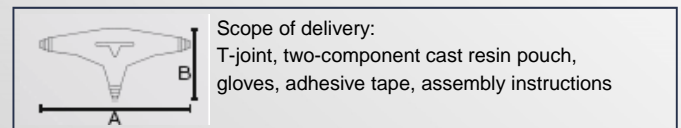



## Heat Shrinkable Tubes

**KISTENMACHER** thin wall Heat Shrinkable Tubes provide an easy to use and durable solution for the protection of cable and cable connections. EGK heat shrinkable tubes will work reliably in temperatures from  $-40^{\circ}\text{C}$  up to  $+125^{\circ}\text{C}$  and provide flame retardancy and UV resistance. The field of application ranges from installation in communication, electronics and aviation to maintenance and cable indexing. Installation of EGK Heat Shrinkable tubes can work with any standard hot air gun with best performance.

**Standard colours: Black, White, Red, Yellow, Blue, Green, other colours on request**

- Shrink Ratio:** 2 : 1
- Operating temp:** - 40 to + 125°C
- Max. voltage:** 660V
- Characteristics:**
- Flexible
  - Non-corrosive
  - High tensile strength
  - UV resistant
  - Flame retardant
  - Good electrical features



**Bi-Colour available on request**



	on carton-roll				
	Art.-No.	Thickness	Size	Mtr. per spool	Mtr. per carton
	EGK HEAT 1	0,18 mm $\pm$ 0,02mm	$\varnothing$ 1,0 / 0,5 mm	200 mtr.	3000 mtr.
	EGK HEAT 1,5	0,18 mm $\pm$ 0,02 mm	$\varnothing$ 1,5 / 0,75 mm	200 mtr.	2600 mtr.
	EGK HEAT 2	0,18 mm $\pm$ 0,02 mm	$\varnothing$ 2,0 / 1,0 mm	200 mtr.	2000 mtr.
	EGK HEAT 2,5	0,18 mm $\pm$ 0,02 mm	$\varnothing$ 2,5 / 1,25 mm	200 mtr.	3000 mtr.
	EGK HEAT 4	0,22 mm $\pm$ 0,02 mm	$\varnothing$ 4,0 / 2,0 mm	200 mtr.	1800 mtr.
	EGK HEAT 5	0,24 mm $\pm$ 0,02 mm	$\varnothing$ 5,0 / 2,5 mm	100 mtr.	1200 mtr.
	EGK HEAT 6	0,24 mm $\pm$ 0,02 mm	$\varnothing$ 6,0 / 3,0 mm	100 mtr.	1000 mtr.
	EGK HEAT 7	0,24 mm $\pm$ 0,02 mm	$\varnothing$ 7,0 / 3,5 mm	100 mtr.	2000 mtr.
	EGK HEAT 8	0,24 mm $\pm$ 0,02 mm	$\varnothing$ 8,0 / 4,0 mm	100 mtr.	1900 mtr.
	EGK HEAT 9	0,24 mm $\pm$ 0,02 mm	$\varnothing$ 9,0 / 4,5 mm	100 mtr.	1800 mtr.
	EGK HEAT 10	0,28 mm $\pm$ 0,02 mm	$\varnothing$ 10,0 / 5,0 mm	100 mtr.	1700 mtr.
	EGK HEAT 11	0,28 mm $\pm$ 0,02 mm	$\varnothing$ 11,0 / 6,5 mm	100 mtr.	1600 mtr.
	EGK HEAT 12	0,28 mm $\pm$ 0,02 mm	$\varnothing$ 12,0 / 6,0 mm	100 mtr.	1500 mtr.
	EGK HEAT 13	0,28 mm $\pm$ 0,02 mm	$\varnothing$ 13,0 / 6,5 mm	100 mtr.	1400 mtr.
	EGK HEAT 14	0,30 mm $\pm$ 0,03mm	$\varnothing$ 14,0 / 7,0 mm	100 mtr.	1400 mtr.
	EGK HEAT 15	0,30 mm $\pm$ 0,03 mm	$\varnothing$ 15,0 / 7,5 mm	100 mtr.	1300 mtr.
	EGK HEAT 16	0,30 mm $\pm$ 0,03 mm	$\varnothing$ 16,0 / 8,0 mm	100 mtr.	1200 mtr.
	EGK HEAT 17	0,35 mm $\pm$ 0,03 mm	$\varnothing$ 17,0 / 8,5 mm	100 mtr.	1100 mtr.
	EGK HEAT 18	0,35 mm $\pm$ 0,03 mm	$\varnothing$ 18,0 / 9,0 mm	100 mtr.	1100 mtr.
	EGK HEAT 19	0,35 mm $\pm$ 0,03 mm	$\varnothing$ 19,0 / 9,5 mm	100 mtr.	1000 mtr.
	EGK HEAT 22	0,35 mm $\pm$ 0,03 mm	$\varnothing$ 22,0 / 11,0 mm	100 mtr.	900 mtr.
	EGK HEAT 25	0,40 mm $\pm$ 0,05 mm	$\varnothing$ 25,0 / 12,5 mm	25 mtr.	500 mtr.
	EGK HEAT 28	0,40 mm $\pm$ 0,05 mm	$\varnothing$ 28,0 / 14,0 mm	25 mtr.	450 mtr.
	EGK HEAT 30	0,40 mm $\pm$ 0,05 mm	$\varnothing$ 30,0 / 15,0 mm	25 mtr.	400 mtr.
	EGK HEAT 35	0,40 mm $\pm$ 0,05 mm	$\varnothing$ 35,0 / 17,5 mm	25 mtr.	350 mtr.
	EGK HEAT 38	0,40 mm $\pm$ 0,05 mm	$\varnothing$ 38,0 / 14,0 mm	25 mtr.	500 mtr.
	EGK HEAT 50	0,40 mm $\pm$ 0,05 mm	$\varnothing$ 50,0 / 25,0 mm	25 mtr.	250 mtr.
	EGK HEAT 80	0,45 mm $\pm$ 0,03 mm	$\varnothing$ 80,0 / 40,0 mm	25 mtr.	200 mtr.
	EGK HEAT 100	0,45 mm $\pm$ 0,03 mm	$\varnothing$ 100,0 / 50,0 mm	25 mtr.	150 mtr.
	EGK HEAT 150	0,50 mm $\pm$ 0,03 mm	$\varnothing$ 150,0 / 75,0 mm	25 mtr.	100 mtr.



## PVC Electrical Tape

**KISTENMACHER** PVC electrical tape is a general purpose insulation tape for most mechanical and electrical applications. Suitable for use as primary insulation for splices up to 600V and for use as outer jacket for splices at higher voltages or simply for bundeling or marking of wires.

### PVC Electrical tape KM-1500:

- Flame retardant
- Resistant to UV rays, water, oil, acids, alkalis, corrosive chemicals
- RoHS and REACH compliant

Backing material: PVC

Adhesive material: Rubber resin

Operating temperature: 0-80°C

Tensile strength: 25 N/cm

Dielectric strength: 40 kv/mm

Max voltage: 600V



Art-No.	Length:	Width:	Thickness:	Colour:	Packing: (pcs. / pack / carton)
EGK ET-1500-0131920 BK	20 meters	19 mm	0,13 mm (5 mil)	black	10 / 100 pcs.
EGK ET-1500-0131920 WH	20 meters	19 mm	0,13 mm (5 mil)	white	10 / 100 pcs.
EGK ET-1500-0131920 BL	20 meters	19 mm	0,13 mm (5 mil)	blue	10 / 100 pcs.
EGK ET-1500-0131920 RE	20 meters	19 mm	0,13 mm (5 mil)	red	10 / 100 pcs.
EGK ET-1500-0131920 GR	20 meters	19 mm	0,13 mm (5 mil)	green	10 / 100 pcs.
EGK ET-1500-0131920 YL	20 meters	19 mm	0,13 mm (5 mil)	yellow	10 / 100 pcs.
EGK ET-1500-0131920 BR	20 meters	19 mm	0,13 mm (5 mil)	brown	10 / 100 pcs.
EGK ET-1500-0131920 VL	20 meters	19 mm	0,13 mm (5 mil)	violet	10 / 100 pcs.
EGK ET-1500-0131920 OR	20 meters	19 mm	0,13 mm (5 mil)	orange	10 / 100 pcs.
EGK ET-1500-0131920 GY	20 meters	19 mm	0,13 mm (5 mil)	grey	10 / 100 pcs.
EGK ET-1500-0131920 YG	20 meters	19 mm	0,13 mm (5 mil)	yellow / green	10 / 100 pcs.
EGK ET-1500-013191Y BK	10 yards	19 mm	0,13 mm (5 mil)	black	10 / 200 pcs.
EGK ET-1500-013191Y WH	10 yards	19 mm	0,13 mm (5 mil)	white	10 / 200 pcs.
EGK ET-1500-013191Y BL	10 yards	19 mm	0,13 mm (5 mil)	blue	10 / 200 pcs.
EGK ET-1500-013191Y RE	10 yards	19 mm	0,13 mm (5 mil)	red	10 / 200 pcs.
EGK ET-1500-013191Y GR	10 yards	19 mm	0,13 mm (5 mil)	green	10 / 200 pcs.
EGK ET-1500-013191Y YL	10 yards	19 mm	0,13 mm (5 mil)	yellow	10 / 200 pcs.
EGK ET-1500-013191Y BR	10 yards	19 mm	0,13 mm (5 mil)	brown	10 / 200 pcs.
EGK ET-1500-013191Y VL	10 yards	19 mm	0,13 mm (5 mil)	violet	10 / 200 pcs.
EGK ET-1500-013191Y OR	10 yards	19 mm	0,13 mm (5 mil)	orange	10 / 200 pcs.
EGK ET-1500-013191Y GY	10 yards	19 mm	0,13 mm (5 mil)	grey	10 / 200 pcs.
EGK ET-1500-013191Y YG	10 yards	19 mm	0,13 mm (5 mil)	yellow / green	10 / 200 pcs.



other specifications are available on request

## CEE Plugs

PCE

015-6

IP44 splashproof



Amp.	Poles	pack. unit	110V~	230V~	400V~
			50/60 Hz 4h	50/60Hz 3p=9h	50/60Hz 3p=9h
			Cat. No.	Cat. No.	Cat. No.
16	3	10	013-4	<b>013-6</b>	013-9
16	4	10	014-4	014-9	<b>014-6</b>
16	5	10	015-4	015-9	<b>015-6</b>
32	3	10	023-4	<b>023-6</b>	023-9
32	4	10	024-4	024-9	<b>024-6</b>
32	5	10	025-4	025-9	<b>025-6</b>

0152-6

IP67 watertight



16	3	10	0132-4	<b>0132-6</b>	0132-9
16	4	10	0142-4	0142-9	<b>0142-6</b>
16	5	10	0152-4	0152-9	<b>0152-6</b>
32	3	10	0232-4	<b>0232-6</b>	0232-9
32	4	10	0242-4	0242-9	<b>0242-6</b>
32	5	10	0252-4	0252-9	<b>0252-6</b>

035-6

IP66/67 watertight



63	3	2	033-4	<b>033-6</b>	033-9
63	4	2	034-4	034-9	<b>034-6</b>
63	5	2	035-4	035-9	<b>035-6</b>

045-6

IP67/67 watertight



125	3	2	043-4	<b>043-6</b>	043-9
125	4	2	044-4	044-9	<b>044-6</b>
125	5	2	045-4	045-9	<b>045-6</b>

## CEE Connectors

PCE



215-6

IP44 splashproof

Amp.	Poles	pack. unit	110V~	230V~	400V~
			50/60 Hz 4h	50/60Hz 3p=9h	50/60Hz 3p=9h
			Cat. No.	Cat. No.	Cat. No.
16	3	10	213-4	<b>213-6</b>	213-9
16	4	10	214-4	214-9	<b>214-6</b>
16	5	10	215-4	215-9	<b>215-6</b>
32	3	10	223-4	<b>223-6</b>	223-9
32	4	10	224-4	224-9	<b>224-6</b>
32	5	10	225-4	225-9	<b>225-6</b>



2152-6

IP67 watertight

16	3	10	2132-4	<b>2132-6</b>	2132-9
16	4	10	2142-4	2142-9	<b>2142-6</b>
16	5	10	2152-4	2152-9	<b>2152-6</b>
32	3	10	2232-4	<b>2232-6</b>	2232-9
32	4	10	2242-4	2242-9	<b>2242-6</b>
32	5	10	2252-4	2252-9	<b>2252-6</b>

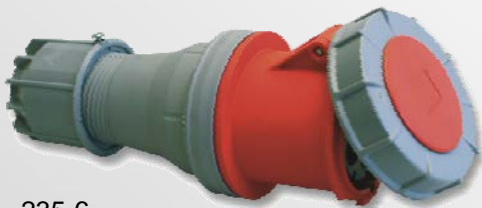

235-6

IP 66/67 watertight

63	3	2	233-4	<b>233-6</b>	233-9
63	4	2	234-4	234-9	<b>234-6</b>
63	5	2	235-4	235-9	<b>235-6</b>

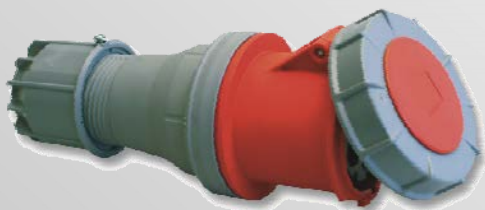

245-6

IP 66/67 watertight

125	3	2	243-4	<b>243-6</b>	243-9
125	4	2	244-4	244-9	<b>244-6</b>
125	5	2	245-4	245-9	<b>245-6</b>

## CEE Wall Mounted Plugs

PCE

**110V~**

50/60 Hz  
4h

**230V~**

50/60Hz  
3p=9h

**400V~**

50/60Hz  
3p=9h

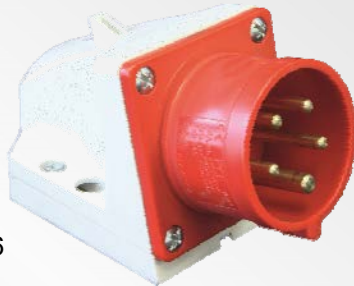

515-6

IP44 splashproof

Amp.	Poles	pack. unit	Cat. No.	Cat. No.	Cat. No.
16	3	10	513-4	513-6	513-9
16	4	10	514-4	514-9	514-6
16	5	10	515-4	515-9	515-6
32	3	10	523-4	523-6	523-9
32	4	10	524-4	524-9	524-6
32	5	10	525-4	525-9	525-6

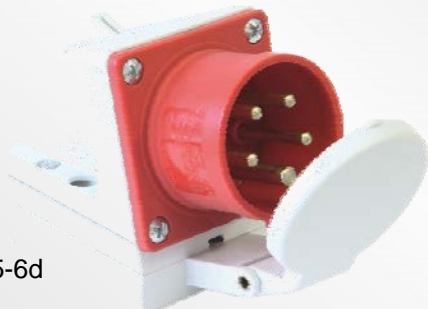

515-6d

IP44 splashproof

16	3	10	513-4d	513-6d	513-9d
16	4	10	514-4d	514-9d	514-6d
16	5	10	515-4d	515-9d	515-6d
32	3	10	523-4d	523-6d	523-9d
32	4	10	524-4d	524-9d	524-6d
32	5	10	525-4d	525-9d	525-6d



535-6

IP67/67 watertight

63	3	2	533-4	533-6	533-9
63	4	2	534-4	534-9	534-6
63	5	2	535-4	535-9	535-6

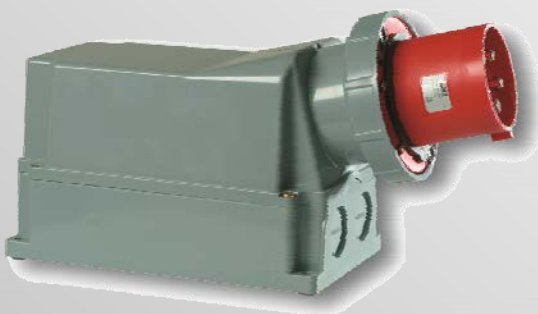

545-6

IP67/67 watertight

125	3	1	543-4	543-6	543-9
125	4	1	544-4	544-9	544-6
125	5	1	545-4	545-9	545-6



## CEE Wall Sockets

PCE

**110V~**

50/60 Hz  
4h

**230V~**

50/60Hz  
3p=9h

**400V~**

50/60Hz  
3p=9h

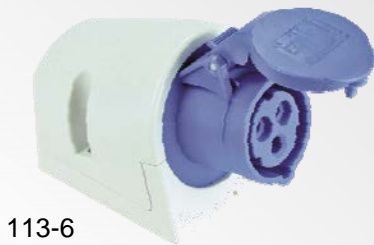

113-6

IP44 splashproof

Amp.	Poles	pack. unit	Cat. No.	Cat. No.	Cat. No.
16	3	10	113-4	113-6	113-9
16	4	10	114-4	114-9	114-6
16	5	10	115-4	115-9	115-6
32	3	10	123-4	123-6	123-9
32	4	10	124-4	124-9	124-6
32	5	10	125-4	125-9	125-6



1152-6

IP67 watertight

16	3	5	1132-4	1132-6	1132-9
16	4	5	1142-4	1142-9	1142-6
16	5	5	1152-4	1152-9	1152-6
32	3	5	1232-4	1232-6	1232-9
32	4	5	1242-4	1242-9	1242-6
32	5	5	1252-4	1252-9	1252-6



115-6k

IP44 splashproof

16	3	10	113-4k	113-6k	113-9k
16	4	10	114-4k	114-9k	114-6k
16	5	10	115-4k	115-9k	115-6k
32	3	10	123-4k	123-6k	123-9k
32	4	10	124-4k	124-9k	124-6k
32	5	10	125-4k	125-9k	125-6k



135-6

IP66/67 watertight

63	3	2	133-4	133-6	133-9
63	4	2	134-4	134-9	134-6
63	5	2	135-4	135-9	135-6

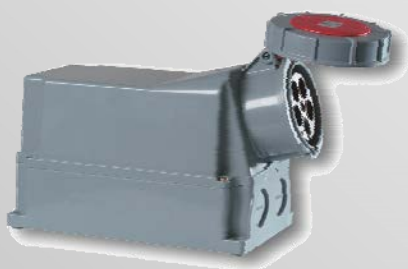

145-6

IP66/67 watertight

125	3	1	143-4	143-6	143-9
125	4	1	144-4	144-9	144-6
125	5	1	145-4	145-9	145-6

## CEE Panel Mounted

PCE

### Straight

315-6f7

IP44 splashproof  
IP44/54 16/3 and 32/3 are splash- + dustproof



Amp.	Poles	pack. unit	110V~	230V~	400V~
			50/60 Hz 4h	50/60Hz 3p=9h	50/60Hz 3p=9h
			Cat. No.	Cat. No.	Cat. No.
16	3	10	313-4f7	313-6f7	313-9f7
16	4	10	314-4f7	314-9f7	314-6f7
16	5	10	315-4f7	315-9f7	315-6f7
32	3	10	323-4f7	323-6f7	323-9f7
32	4	10	324-4f7	324-9f7	324-6f7
32	5	10	325-4f7	325-9f7	325-6f7

3152-6

IP67 watertight



16	3	10	3132-4	3132-6	3132-9
16	4	10	3142-4	3142-9	3142-6
16	5	10	3152-4	3152-9	3152-6
32	3	10	3232-4	3232-6	3232-9
32	4	10	3242-4	3242-9	3242-6
32	5	10	3252-4	3252-9	3252-6

315-6

IP44 splashproof  
IP44/54 16/3 and 32/3 are splash- + dustproof



16	3	10	313-4	313-6	313-9
16	4	10	314-4	314-9	314-6
16	5	10	315-4	315-9	315-6
32	3	10	323-4	323-6	323-9
32	4	10	324-4	324-9	324-6
32	5	10	325-4	325-9	325-6

### Slopping

415-6

IP44 splashproof  
IP44/54 16/3, 16/5 and 32/3 are splash- + dustproof



16	3	10	413-4f8	413-6f8	413-9f8
16	4	10	414-4f8	414-9f8	414-6f8
16	5	10	415-4	415-9	415-6
32	3	10	423-4	423-6	423-9
32	4	10	424-4	424-9	424-6
32	5	10	425-4	425-9	425-6

## Pressure Switches



MDR 1 / 6



MDR 1 / 11

### MDR 1 / 6

Pump version,  
incl. cable glands PG 11 Z/ZK

Switching Capacity	Max. Cut-Out Pressure	Poles	Flange Type	Phase
4.0 kW	6 bar	2-pole (N.C)	Steel	Single

### MDR 1 / 11

Compressor version,

Switching Capacity	Max. Cut-Out Pressure	Poles	Flange Type	Phase
4.0 kW	11 bar	2-pole (N.C)	Aluminium	Single



MDR 11 / 6  
MDR 11 / 11

### MDR 11 / 6

Pump version,

Switching Capacity	Max. Cut-Out Pressure	Poles	Flange Type	Phase
4.0 kW	6 bar	2-pole (N.C)	Steel	Single

### MDR 11 / 11

Compressor version,

incl. cable glands PG 13.5 Z/ZK

Switching Capacity	Max. Cut-Out Pressure	Poles	Flange Type	Phase
4.0 kW	11 bar	2-pole (N.C)	Aluminium	Single



MDR 2



### MDR 2

with screw terminals

Switching Capacity	Max. Cut-Out Pressure	Poles	Flange Type	Phase
2.2 kW	12 bar	2-pole (N.C)	Aluminium	Single



MDR 21



### MDR 21

Switching Capacity	Max. Cut-Out Pressure	Poles	Flange Type	Phase
2.2 kW	12 bar	2-pole (N.C)	Aluminium	Single



MDR 3



### MDR 3

available with overload relay, undervoltage protection and hourmeter

Switching Capacity	Max. Cut-Out Pressure	Poles	Flange Type	Phase
7.5 (11) kW	35 bar	3-pole (N.C)	Aluminium	3-Phase

## Pressure Switches



MDR 4 S



MDR 43

Switching Capacity	Max. Cut-Out Pressure	Poles	Flange Type	Phase
5.5 kW	25 bar	3-pole (N.C)	Aluminium	3-Phase

### MDR 43

transparent cover

Switching Capacity	Max. Cut-Out Pressure	Poles	Flange Type	Phase
-	16 bar	1 N.C + 1 N.O	Aluminium	Single



MDR 4 SD



MDR 4 SU

### MDR 4 SD

with scale and transparent cover

Switching Capacity	Max. Cut-Out Pressure	Poles	Flange Type	Phase
5.5 kW	11 bar	3-pole (N.C)	Aluminium	3-Phase

### MDR 4 SU

with reversed function

Switching Capacity	Max. Cut-Out Pressure	Poles	Flange Type	Phase
4.0 kW	16 bar	3-pole (N.C)	Aluminium	3-Phase



MDR 5



MDR 5 IP65

### MDR 5

Switching Capacity	Max. Cut-Out Pressure	Poles	Flange Type	Phase
5.5 kW	45 bar	3-pole (N.C)	-	Single

### MDR 5 IP65

Pump version, special execution IP 65

Applications: e.g. pump shafts

Switching Capacity	Max. Cut-Out Pressure	Poles	Flange Type	Phase
5.5 kW	16 bar	3-pole (N.C)	Aluminium	3-Phase



MDR 53



MDR F

### MDR 53

ample wiring room, 1 SPDT, 1 change over

Switching Capacity	Max. Cut-Out Pressure	Poles	Flange Type	Phase
	16 bar	2-pole (N.C)	Aluminium	Single

### MDR F - High Performance Pressure Switch

ample wiring room, 1 SPDT, models Industrial clamp version or industrial screw version with Perbunan diaphragm and die-cast aluminum flange for oil, water e.g.

Switching Capacity	Max. Cut-Out Pressure	Poles	Flange Type	Phase
	250 bar	1 SPDT *	Aluminium	Single

\* DPDT also available

### various additional accessories

available upon your request



additional approvals  
upon your request





## Coaxial Cables RG 6

Specification:

Core: CCS - 1,0 mm diameter  
 Dielectric insulator: PE Foam - 4,8 mm thickness  
 Shielding: Aluminium foil 0,04 mm + 32 x 0,12 mm aluminium wires  
 Outer sheath: PVC - 0,9 mm thickness

### Coaxial cables on coils

Art-No.	Length	Connectors	Colour	Packing (coils / carton)
EGK RG6 BL20 Y	20 yards	2 x F-Connector	Black	12 coils
EGK RG6 BL30 Y	30 yards	2 x F-Connector	Black	12 coils
EGK RG6 BL50 Y	50 yards	plain ends	Black	6 coils
EGK RG6 BL90 Y	90 yards	plain ends	Black	6 coils
EGK RG6 WH20 Y	20 yards	2 x F-Connector	White	12 coils
EGK RG6 WH30 Y	30 yards	2 x F-Connector	White	12 coils
EGK RG6 WH50 Y	50 yards	plain ends	White	6 coils



### Coaxial cables in dispenser boxes

Art-No.	Length	Connectors	Colour	Packing (boxes / carton)
EGK RG6 BL100 Y BOX	100 yards	plain ends	Black	6 boxes
EGK RG6 WH100 Y BOX	100 yards	plain ends	White	6 boxes



## CAT 6

Art-No.	Length	CCA	HDPE	Cord + Cross	Colour	Packing (boxes / carton)
EGK CAT6 GR 305M BOX	305 meter	0,57 mm	1,02 mm	6,0 mm	Grey	2 boxes
EGK CAT6 GR 305M BOX ECO	305 meter	0,51 mm	0,93 mm	5,7 mm	Grey	2 boxes

Specification:

Class: CAT 6  
 Material of conductor: CCA  
 Impedance: 100 Ω  
 Suitable for: 10 Mbit, 100 Mbit, 1 Gbit  
 TIA: 250 MHz  
 Shielding: U/U / UTP



## Rubber and Control Cables



H05VV-F



H07RN-F



H05RR-F



JZ 500 - flexible



F-CY-JZ - copper screened



Y-CY-JZ - copper screened, transparent

## SAT and Heat Resistant Cables



Coaxial Cable



SIF, SIF/GL, SIFF, SID, SID/GL

## CAT Cables

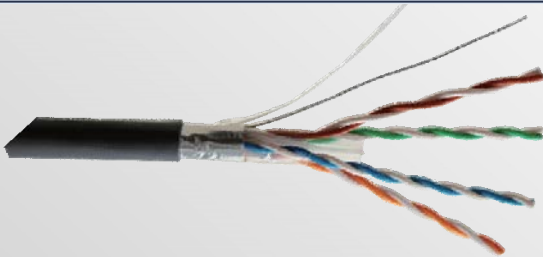

CAT 6



CAT 7

## Cable Rollers



### Cable Corner Rollers / Cable Laying Rollers

with steel roller bodies, running in ball bearings and steel frame, galvanized

Art. No.	Carrying capacity	For cable dia. up to	Dimensions	Weight
080-1901-001 (laying type)	250 kg	150 mm	300 x 240 x 255 mm	3,70 kg
080-1901-031 (corner type)	500 kg (vertical rollers) 250 kg (horizontal rollers)	100 mm	550 x 340 x 360 mm	10,30 kg

*more types available upon your request*

## Mechanical Cable Cutters

### Mechanical Cable Cutter for Cu and Al Cables

PVC coated handles with blue/yellow insulation, suitable for CU and AL Cables.

not suitable for cutting steel or steel wire



Art. No.	Cutting Range	Length
K 100	max. Ø 14 mm	280 mm

### Mechanical Cable Cutter for Cu and Al Cables

PVC coated handles with blue/yellow insulation, suitable for CU and AL Cables.

not suitable for cutting steel or steel wire



Art. No.	Cutting Range	Length
K 101/1	max. Ø 26 mm	570 mm

### Mechanical Cable Cutter for Cu and Al Cables

PVC coated handles with blue/yellow insulation, suitable for CU and AL Cables.

not suitable for cutting steel or steel wire



Art. No.	Cutting Range	Length
K 101/2	max. Ø 38 mm	930 mm

### Mechanical Cable Cutter for Cu and Al Cables

PVC coated handles with blue/yellow insulation, suitable for CU and AL Cables.

not suitable for cutting steel or steel wire



Art. No.	Cutting Range	Length
K 130	max. Ø 30 mm	570 mm
K 150	max. Ø 50 mm	710 mm

### Mechanical Cable Cutter for Cu and Al Cables

PVC coated handles with blue/yellow insulation, suitable for CU and AL Cables.

not suitable for cutting steel or steel wire



Art. No.	Cross Ref.	Cutting Range	Length
SH 600	K 103/1	max. Ø 60 mm	720 mm

### Mechanical Cable Cutter for Cu and Al Cables

PVC coated handles with blue/yellow insulation, suitable for CU and AL Cables.

not suitable for cutting steel or steel wire



Art. No.	Cross Ref.	Cutting Range	Length
SH 1000	K 104/1	max. Ø 100 mm	870 mm

### Mechanical Cable Cutter for Cu and Al Cables

PVC coated handles with blue insulation, suitable for CU and AL Cables.

not suitable for cutting steel or steel wire



Art. No.	Cross Ref.	Cutting Range	Length
SH 320	K 106/1	max. Ø 32 mm	260 mm

### Mechanical Cable Cutter for Cu and Al Cables

PVC coated handles with blue insulation, suitable for CU and AL Cables.

not suitable for cutting steel or steel wire



Art. No.	Cross Ref.	Cutting Range	Length
SH 500	K 106/2	max. Ø 52 mm	285 mm

## Mechanical Crimping Tools



### Mechanical Crimping Tools with revolving dies Hexagonal crimping



Art. No.	Crimping Range	Length
K 05	6-50 mm <sup>2</sup>	390 mm
K 06	10-120 mm <sup>2</sup>	650 mm
K 09	25-150 mm <sup>2</sup>	650 mm

mechanical crimping tool for tubular cable lugs and connectors, standard type, with revolving dies, PVC coated handles, with blue/yellow insulation

### Mechanical Crimping Tools with revolving dies Indent crimping



Art. No.	Crimping Range	Length
K 5	6 - 50 mm <sup>2</sup>	600 mm
K 6	50 - 120 mm <sup>2</sup>	970 mm
K 7	120 - 240 mm <sup>2</sup>	975 mm
K 07	185 - 400 mm <sup>2</sup>	975 mm
K 8	35 - 95 mm <sup>2</sup>	975 mm

mechanical crimping tool for tubular cable lugs and connectors, standard type, with revolving dies, PVC coated handles, with blue/yellow insulation

### Crimping Hand Tool

suitable for red/blue/yellow insulated DIN cable lugs, pin cable lugs, tabs and receptacles, circular connectors and receptacles butt and parallel connectors



### Crimping Hand Tool

with exchangeable crimping Die Sets



Art. No.	Cross Ref.	Range	Application
CK 100 SET	CK 100-44	0,5 - 6,0 mm <sup>2</sup>	red/blue/yellow cable lugs/ pin cable lugs, tabs, receptacles, circular connectors, butt parallel connectors
CK 100 SET	CK 100-65	0,5 - 10,0 mm <sup>2</sup>	flat push-on receptacles and tabs without insulation
CK 100 SET	CK 100-AE21	0,14 - 10,0 mm <sup>2</sup>	wire end ferrules with and without insulation sleeve

Art. No.	Cross Ref.	Red	Blue	Yellow
CK 90-44	CK 90	0,5 - 1,0 mm <sup>2</sup>	1,5 - 2,5 mm <sup>2</sup>	4,0 - 6,0 mm <sup>2</sup>

### Hydraulic Punching Tools

punches accurate slugs nearly free of burrs, easy single handed using with small effort



LS8



LS6

Art. No.	Cross Ref.	Punching Capacity	Punching Force	Handle
LS8	50-600	steel plates up to max. 3 mm	80 kN	straight
LS6	50-099	steel plates up to max. 3 mm	60 kN	angled



LS8-SET

Art. No.	Cross Ref.	Cutting Edges and Matrix	Components
LS8-SET	50-608	dia. 16,5mm (M16), 20,5mm (M20), 25,5mm (M25), 32,5 mm (M32)	3 Elastic Inserts, 1 Sleeve, 1 Adapter, 1 Rod, 1 Plastic Case with Insert



## Battery Operated Hydraulic Tools



### Hydraulic Crimping Tool Set



- with open head

battery powered with memory card, packed in blue metal carrying case

- rotating crimping head
- yellow chromated, Cu-hexagonal crimping dies
- spare battery, battery charger, software and USB data cable



Art. No.	Crimping Force	Crimping Range	Number of dies
APE 6-22 KI	60 kN	10 - 300 mm <sup>2</sup>	12

### Hydraulic Crimping Tool Set



- with C head (29 mm)

Art. No.	Crimping Force	Crimping Range	Number of dies
APE 13C KI	130 kN	10 - 400 mm <sup>2</sup>	13

### Hydraulic Crimping Tool Set



- rotating crimping head
- yellow chromated, Cu-hexagonal crimping dies
- spare battery, battery charger, software and USB data cable

- with open head

Both battery powered with memory card, packed in blue metal carrying case



Art. No.	Crimping Force	Crimping Range	Number of dies
APEM 5-5	50 kN	- 10 -150 mm <sup>2</sup> (Aluminium)	9
		- 10 - 185 mm <sup>2</sup> (Copper)	10
		- 10 - 240 mm <sup>2</sup> (Standard)	11

### Hydraulic Cutting Tool Set

- rotating cutting head
- yellow chromated, Cu-hexagonal crimping dies
- spare battery, battery charger, software and USB data cable



Art. No.	Cutting Force	Cutting Range
ASE 85 KI	70 kN	max. 85 mm <sup>2</sup>

### Electrohydraulic Pump for use with mains 220 - 240V



For use with mains 220 - 240V, with digital pressure gauge, equipped with 2 mtr hydraulic hose and quick couplings, suitable to connect most common crimping and cutting devices.

*Longer hydraulic hoses and bigger tank volume available on request*

- max. pressure (HD) 700 bar
- min. pressure (ND) 60 bar
- haul capacity (HD) 0,34 l / min
- haul capacity (ND) 0,80 l / min
- motor capacity 0,37 kw
- engine rpm 1360
- tank volume 2,0 ltr
- weight 18,0 kgs
- voltage 220 - 240 V / 50 / 60 Hz
- noise level 75 dB A

Art. No.	Operating Pressure	Motor Capacity
AKPE2 KI	700 bar	0,37 kw

### Battery Operated Hydraulic Drive Unit

Equipped with 1,50 mtr. Hydraulic high pressure hose and quick couplings, suitable to connect most common crimping and cutting devices, total weight 4,90 kgs only

Including:

- remote control and strap
- bag
- read-out option of the machine status
- failure analysis
- li-ion battery 3.000 mA / 18V



Art. No.	Operating Pressure
AKPE1 KI	700 bar

## Hydraulic Crimping and Cutting Tools



### Hydraulic Crimping Tool with Foot Pump



Art. No.	Crimping Force	Crimping Range
SET PK 250 KI	250 kN	16 - 630 mm <sup>2</sup>
SET PK 450 KI	450 kN	95 - 1.000 mm <sup>2</sup>

foot-operated double piston pump, 700 bar, with automatic change-over and pressure relief valve and coupling, complete with 2 mtr. mounted high pressure hose, with rotating nickel plated crimping head in blue metal transport case with yellow chromated Cu-hexagonal crimping dies, sets consisting of the following dies:

SET PK 250 (14 pieces)

16, 25, 35, 50, 70, 95, 120, 150, 185, 240, 300, 400, 500, 630 mm<sup>2</sup>

SET PK 450 (11 pieces)

95, 120, 150, 185, 240, 300, 400, 500, 635, 800, 1.000 mm<sup>2</sup>

resp. 11 pcs - PK450)

### Hydraulic Cable Cutting Tool with Foot Pump



Art. No.	Cutting Force	Cutting Range
SET SK 85 KI	70 kN	85 mm
SET SK 120 KI	100 kN	120 mm

foot-operated double piston pump, 700 bar, with automatic change-over and pressure relief valve and coupling, complete with 2 mtr. mounted high pressure hose, with rotating cutting head in blue metal transport case

suitable for aluminium and copper cable

### Hydraulic Foot Pump



Art. No.	Pressure	Hose Length
FP 700	700 Bar	2 meters

foot-operated double piston pump with automatic change-over and pressure relief valve and coupling, complete with 2 mtr. mounted high pressure hose

### Hydraulic Cable Cutter Head

chrome-plated rotating cutting head with double piston pump and automatic safety relief valve

suitable for power copper and aluminium cables



Art. No.	Cutting Force	Cutting Range
SK 85 KI	70 kN	85 mm

### Hydraulic Cable Cutter Head

black lacquered rotating cutting head with double piston pump and automatic safety relief valve



Art. No.	Cutting Force	Cutting Range	Suitable Cables
SK 120 KI	100 kN	120 mm	Cu + Al
SK 120 ST-KI	135 kN	120 mm	Armoured Copper

### Hydraulic Cable Cutter Head

black lacquered rotating cutting head with double piston pump and automatic safety relief valve

suitable for **armoured copper**, aluminium, ACSR cables and solid steel bars up to 16 mm



Art. No.	Cutting Force	Cutting Range
SK 45 KI	70 kN	45 mm

### Hydraulic Cable Cutter Head - Shear Type - open

with quick coupling suitable for foot pump / electro pump up to 700bar, suitable for power copper and aluminium cables



Art. No.	Cutting Force	Cutting Range
SK 120 O	100 kN	120 mm

## Hydraulic Crimping and Cutting Tool Sets



### Hydraulic Crimping Tool Set

hand-operated, with rotating C-compression head, double piston pump and automatic safety relief valve, in blue metal carrying case  
complete with yellow chromated CU-hexagonal crimping dies (13 pcs)



Art. No.	Crimping Force	Crimping Force
SET PK 130 KI	130 kN	10 - 400 mm <sup>2</sup>

### Hydraulic Crimping Tool Set

hand-operated, with rotating C-compression head, double piston pump and automatic safety relief valve, in blue metal carrying case  
complete with yellow chromated CU-hexagonal crimping dies (13 pcs)

with extra large opening of 42mm head, suitable as well for C- and H-Clamps



Art. No.	Crimping Force	Crimping Force
SET PK 130 KI / 42	130 kN	10 - 400 mm <sup>2</sup>

### Hydraulic Crimping Tool Set

hand-operated, with rotating round-compression head, double piston pump and automatic safety relief valve, in blue metal carrying case  
complete with yellow chromated CU-hexagonal crimping dies (12 pcs)



Art. No.	Crimping Force	Crimping Range
SET HP60/22 KI	60 kN	10-300 mm <sup>2</sup>

### Hydraulic Cable Cutter HKS

hand-operated, with rotating cutting head, double piston pump and automatic safety relief valve, in blue metal carrying case  
suitable for copper and aluminium cables.



Art. No.	Cutting Force	Cutting Range	Suitable Cables
HS 45 KI	60 kN	max. 45 mm <sup>2</sup>	Armoured Copper
HS 50 KI	60 kN	max. 50 mm <sup>2</sup>	Cu + Al
HS 85 KI	70 kN	max. 85 mm <sup>2</sup>	Cu + Al

## Cable and Wire Strippers



For most common coaxial-cable types and round PVC cables

Art. No.	Coaxial Cable	PVC Cable
30600	4,8 - 7,5 mm Ø	3 x 0,75 mm <sup>2</sup>



For all standard insulated round cables

Art. No.	Cable	NYM Cables
30155	8 - 13 mm Ø	3 x 1,5 to 5 x 2,5 mm <sup>2</sup>



10350



10270

For all common round cables, with automatic TiN coated swivel-blade, screw to adjust cutting depth, spare-blade is stored inside the handle

Art. No.	Cable
10160	4 - 16 mm Ø
10270	8 - 28 mm Ø
10350	27 - 35 mm Ø

20100



Art. No.	Cable
20100	0,2 - 6 mm <sup>2</sup>
20090	6 - 16 mm <sup>2</sup>



20090

Ergonomic and automatic wire stripper, suitable for cables and wires with insulation of PVC and other materials



29310



29300

Art. No.	Cable
29310	3,2 - 4,4 mm <sup>2</sup>
29300	4,4 - 7 mm <sup>2</sup>

## Hydraulic Punch Drivers

**KISTENMACHER** punching tools are a reliable solution for most punching applications on mild steel and aluminium sheets. This line covers manual and hydraulic tools.

### Hydraulic Punch Driver - EGK WK-8AL:

- Extremely versatile and easy-to-use hole punching tool thanks to 360° rotatable punching head
- Leightweight aluminium construction for easy operation and effortless portability

Punching range:	Ø 22,5 - 61,5 mm / 3,5 mm mild steel
Punching force:	70 KN
Stroke:	25 mm
Weight:	about 2,10 kg

Accessories:	Punches (type D): 22,5 - 22,3 - 34,6 - 43,2 - 49,6 - 61,5 mm 7/16" x 3/4" draw stud 3/4" x 3/4" draw stud Spacer Sealing kit
--------------	--



### Hydraulic Punch Driver - EGK WK-12AL:

- Extremely versatile and easy-to-use hole punching tool thanks to 360° rotatable punching head
- Leightweight aluminium construction for easy operation and effortless portability

Punching range:	Ø 22,5 - 61,5 mm / 3,5 mm mild steel
Punching force:	120 KN
Stroke:	27 mm
Weight:	about 3,00 kg

Accessories:	Punches (type D): 22,5 - 22,3 - 34,6 - 43,2 - 49,6 - 61,5 mm 7/16" x 3/4" draw stud 3/4" x 3/4" draw stud Spacer Sealing kit
--------------	--





## Punching Technology

**KISTENMACHER** punching tools are a reliable solution for most punching applications on mild steel and aluminium sheets. This line covers manual and hydraulic tools.

### Manual Knock Out Punch Kit 1/2" - 1 1/4". - EGK MPS 1/2-

Description	Hole Size (actual)	
	Ø inch	Ø mm
1/2" Conduit size punch and die	7/8"	22,50
3/4" Conduit size punch and die	1,115"	28,30
1" Conduit size punch and die	1,362"	34,60
1"-1/4" Conduit size punch and die	1,701"	43,20
3/8" , 24UN Draw stud with bearing		
3/4" , 16UN Draw stud with bearing		



### Manual Knock Out Punch Kit 1 1/2" - 2" - EGK MPS 1.1/2-2:

Description	Hole Size (actual)	
	Ø inch	Ø mm
1 - 1/2" Conduit size punch and die	1-15/16"	49,60
2" Conduit size punch and die	2-3/8"	61,50



## VDE Screwdrivers

**ALL-IN-ONE 1 SCREWDRIVER for 6 SIZES**

### ALL-IN-ONE Screwdriver VDE



only 1 screwdriver covers 6 different cross slot sizes i.e. PH No. 1, 2, 3 and PZ No. 1, 2, 3

red insulated blade, with black tip, insulated up to 1000V AC, GS approved

Blade: from high-alloy special steel  
Handle: ergonomic design, 2 component type

Art. No.	Blade length	Handle length
SET 01500	100 mm	117 x 33 mm



*sales assistance with 36 pieces*

### Screwdrivers Set VDE

red insulated blade, with black tip, insulated up to 1000V AC, GS approved



**Comfort Line VDE**  
Art. No. 65604



**Basic Line VDE**  
Art. No. 56080

Art. No.	Quantity	Bit Type	Art. No.	Specifications
65604	4x	PH	Art. No. 6647	2.5 x 75; 4.0 x 100; 5.5 x 125; 6.5 x 150
	2x	+	Art. No. 6636	PH 1; PH 2 (optional PZ)
	1x	PH	Art. No. 401	Voltage Tester
56080	3x	PH	Art. No. 647	2.5 x 75; 4.0 x 100; 5.5 x 125; 6.5 x 150
	2x	+	Art. No. 636	PH 1; PH 2 (optional PZ)
	1x	PH	Art. No. 401	Voltage Tester

### Screwdrivers Comfort Line VDE

red insulated blade, with black tip, 2 component handle, insulated up to 1000V AC, GS approved

1 VDE - Electricians Slot      2 VDE PH/PZ - Cross Tip



### Screwdrivers Basic Line VDE

red insulated blade, with black tip, basic plastic handle, insulated up to 1000V AC, GS approved

3 VDE - Electricians Slot      4 VDE PH/PZ - Cross Tip



mm	1		3	
	Art. No.	Art. No.	Art. No.	Art. No.
2.5 x 75	66470	64700		
2.5 x 75	66471	64701		
3.0 x 100	66472	64702		
3.5 x 100	66473	64703		
4.0 x 100	66474	64704		
5.5 x 125	66475	64705		
6.5 x 150	66476	64706		
8.0 x 175	66477	64707		
10.0 x 200	66478	64708		

PH	2		4	
	Art. No.	Art. No.	Art. No.	Art. No.
0	66360	63600		
1	66361	63601		
2	66362	63602		
3	66363	63603		
4	66364	63604		
PZ				
	0	66380	63800	
1	66381	63801		
2	66382	63802		
3	66383	63803		
4	66384	63804		

## Hole Saws



### Bi-Metal Hole Saws

M42 / 4 - 6 tpi, white



### Accessories



Art. No.	Width (mm)	Art. No.	Width (mm)	Art. No.	Width (mm)	Art. No.	Width (mm)	Art. No.	Width (mm)
CT 14	14	CT 32	32	CT 52	52	CT 76	76	CT 121	121
CT 16	16	CT 33	33	CT 54	54	CT 79	79	CT 127	127
CT 17	17	CT 35	35	CT 57	57	CT 83	83	CT 133	133
CT 19	19	CT 37	37	CT 58	58	CT 86	86	CT 140	140
CT 20	20	CT 38	38	CT 59	59	CT 89	89	CT 146	146
CT 21	21	CT 40	40	CT 60	60	CT 92	92	CT 152	152
CT 22	22	CT 41	41	CT 63	63	CT 95	95	CT 160	160
CT 23	23	CT 43	43	CT 64	64	CT 98	98	CT 168	168
CT 24	24	CT 44	44	CT 65	65	CT 102	102	CT 177	177
CT 25	25	CT 46	46	CT 67	67	CT 105	105	CT 200	200
CT 27	27	CT 48	48	CT 68	68	CT 108	108	CT 210	210
CT 29	29	CT 50	50	CT 70	70	CT 111	111		
CT 30	30	CT 51	51	CT 73	73	CT 114	114		

Art. No.	Arbors
A1	8,5 mm / Ø 14 - 30 mm - hex shank
A2	11 mm / Ø 14 - 30 mm - hex shank
A3	8,5 mm / Ø 32 - 210 mm - hex shank, pull system
A4	11 mm / Ø 32 - 210 mm - hex shank, pull system
A5	11 mm / Ø 32 - 210 mm - hex shank, screw system
A7	Ø 14 - 30 mm - SDS
A8	Ø 32 - 210 mm - SDS, pull system
A10	6,35 mm / Ø 14 - 30 mm - three-sided shank
Drills	
B1	6,35 mm / Ø 83mm - for A1, A2, A3, A4, A5, A7, A8
B2	6,35 mm / Ø 105mm - for A1, A2, A3, A4, A5, A7, A8, A10
Extension Bars	
V 8,5	300mm - for A1, A3, A13
V 10	300mm - for A2, A4, A5, A15
F	Pressure Spring

## Pliers

### Original ODUR-„Fit“ Shear Pliers



### ODÜR - FIT Pliers

Polished and high quality plastic handles



14/8"



15/8"

**14/8"** 12 individually boxes packed in one display carton

300 pcs in wooden case or 720 pcs in strong export carton

**15/8"** 12 individually hang up cartons packed in one carton packing.



Art. No.	Handle	Length	Weight	Packing
14/8"	Isolated	200 mm / 8 inch	280 g	Single Box
15/8"	2-component handles	200 mm / 8 inch	300 g	Hang Up Carton

## Pliers



### VDE Pliers Set 4 pcs.



- 1 x long nose plier (35/160)
  - 1 x side cutting plier (40/160)
  - 1 x combination plier (65/180)
  - 1 x insulation stripping plier (79/160)
- packing in strong display box

Art. No.	Handle
A3-VDE-2K	VDE heavy opaque 2-component handles
A3-VDE-SF	VDE directly injected 1000V insulating handles

## Electronic Voltage Tester



### Volt Check 3.1 IP 40

Art. No.	Range	Display
991895	6-400V AC/DC	LED



### Master Check battery powered, IP 65

Art. No.	Range	Display
991888	6-400V AC/DC	LED



### Combi Check battery powered, IP 65

Art. No.	Range	Display
991886	6-690V AC/DC	LED



### Combi Check PRO battery powered, IP 65

Art. No.	Range	Display
127933	6-690V AC/DC	LED



### Multi Check battery powered, IP 65

Art. No.	Range	Display
991892	5-500V AC/DC	LCD



### Digi Check battery powered, IP 65

Art. No.	Range	Display
991885	5-690V AC/DC	LCD



### Digi Check PRO battery powered, IP 65

Art. No.	Range	Display
991887	5-690V AC/DC	LCD



## Detectors



### Electronic Multi Tester MT 6 S/2



- non-contact location of cables with AC voltage
- checking phase, neutral and earthing conductor at the sockets
- continuity check, e.g. of fuses, bulbs etc.
- polarity check, e.g. of batteries
- display through the LED
- small and handy
- can be used as a torch because of the super-bright LED
- inclusive 3 replaceable coin cells



Art. No.	Packing
1 29715 0	5 pieces

### Moisture Detector MD



- to determine the moisture content of wood building material, such as e.g. concrete, brick, screed, plasterboard, wallpaper etc
- measuring range of 5-50% for wood, or 1,5-33% for building material
- large LCD display (resolution 0,1%) as well as acoustically
- practical hold function also makes measurement possible at locations difficult to access
- automatic switch-off appr. 3min after last application
- battery low voltage display
- robust, ergonomic housing with separate compartment for 9V monobloc battery (not included)
- with protective cap

Art. No.	Packing
129 86 80	1 piece

### Multifunction Detector WMV Plus



- for locating metal, voltage carrying cables (AV voltage) and wooden beams e.g. in walls
- 3 functions on one appliance, functions can be individually applied
- accurate display of the result on large LCD display
- automatic sensitivity control
- battery compartment for 9V block (battery not included)
- automatic switch-off after end of measurement
- battery low voltage display
- maximum detection: wood up to 40mm, AC voltage appr. 30-50mm, metal appr. 50-80mm
- user friendly through the operation button on the side and front.

Art. No.	Packing
1 29818 0	1 piece



## Voltage and Car Light Testers



### Voltage Tester 100 - 500 V with brass cap



+ clip

( clear )

Art. No.	Colour	Length
451 PM/k	clear	125 mm
452 PM/k	clear	140 mm

Art. No.	Colour	Length
457 PM/k	clear	190 mm

( yellow )



Art. No.	Colour	Length
451 PM/g	yellow	125 mm
452 PM/kg	yellow	140 mm



Art. No.	Colour	Length
457 PM/g	yellow	190 mm

600 pcs /  
carton  
2400 pcs /  
carton

1200 pcs /  
carton

### Voltage Tester 100 - 500 V with plastic cap and clip



( clear )

Art. No.	Colour	Length
451 P/k	clear	125 mm
452 P/k	clear	140 mm



( yellow )

Art. No.	Colour	Length
451 P/g	yellow	125 mm
452 P/kg	yellow	140 mm

600 pcs /  
carton  
2400 pcs /  
carton

### Euro Voltage Tester 125 - 250 V with plastic clip

Art. No.	Colour	Length
45300P/b	blue	150 mm
45800P/b	blue	190 mm

Art. No.	Colour	Length
45400P/r	red	150 mm
45900P/r	red	190 mm

Art. No.	Colour	Length
45300P/o	orange	150 mm
45800P/o	orange	190 mm



### Car Light Tester 6 - 24 V with cable and crocodile clip



( brass )

Art. No.	Colour	Length
4598 A	yellow	120 mm



( PVC )

Art. No.	Colour	Length
4568 A	yellow	120 mm

### Spark Plug Tester



Art. No.	Colour	Length
4568Z	yellow	120 mm

### Car Light + Spark Plug Tester Set 6 - 24 V

with cable and crocodile clip,  
in single plastic wallets  
including Art. No. 4568A + 4568Z

Art. No.	Colour	Length
4518 ZA/T	yellow	120 mm

### SECUPEN Voltage Tester 100 - 250V



Art. No.	Length	Packing
17150/C	137 mm	1000 pcs
17151/C	215 mm	400 pcs

with clip hanger



Art. No.	Length	Packing
17150/B	137 mm	400 pcs / box
17151/B	215 mm	600 pcs / box

without clip hanger, bulk packing



Art. No.	Length	Packing
17150/D	137 mm	40 pcs / box
17151/D	215 mm	40 pcs / box

without clip hanger, in display box

## Hot Air Guns

**HL 1400 S**



- promotion type - starter model

**HL 1620 S**



- with two heating and airflow stages

Model	Art. No. (Schuko-Plug)	Art. No. (BS-Plug)	Output (Watt)	Melt Temp. (°C)	Voltage	Airflow Rate	Temp. Setting
HL 1400 S	345914	n. a.	1400	300 / 500	220 - 230	In 2 steps	2-stage
HL 1620 S	351106	009632	1600	300 / 500	220 - 230	In 2 steps	2-stage

**HL 1920 E**



- electronically controlled hot air gun with temperature control and cool air stage

**HG 2320 E**



- electronically controlled hot air gun with continuously adjustable air flow and temperature control
- LCD display mode in 10°C steps

Model	Art. No. (Schuko-Plug)	Art. No. (BS-Plug)	Output (Watt)	Melt Temp. (°C)	Voltage	Airflow Rate	Temp. Setting
HL 1920 E	352103	009649	2000	80 - 600	220 - 230	In 3 steps	9-stage
HG 2320 E	007386	009663	2300	80 - 650	220 - 230	In 2 steps	

**HL 2020 E**



- with LCD display
- microprocessor controlled hot air gun with temperature control and cool air stage

**HL 2020 E CASE**



- HL 2020 E with LCD display
- delivered in a case including 9 mm reduction nozzle

Model	Art. No. (Schuko-Plug)	Art. No. (BS-Plug)	Output (Watt)	Melt Temp. (°C)	Voltage	Airflow Rate	Temp. Setting
HL 2020 E	008192	009656	2200	80 - 630	220 - 230	In 3 steps	in 10°C steps
HL 2020 E/Case	352202	012007	2200	80 - 630	220 - 230	In 3 steps	in 10°C steps

## Glue Guns

### GLUEMATIC 3002



- attractively priced glue gun
- electronically controlled with high melt capacity for diyers and professional users
- including 3 glue sticks

### SET GLUEMATIC 3002



- attractively priced glue gun
- electronically controlled with high melt capacity for diyers and professional users
- packed in PVC case, including 8 glue sticks

Model	Art. No. (Schuko-Plug)	Art. No. (BS-Plug)	Output (Watt)	Melt Temp. (°C)	Voltage
GLUEMATIC 3002	333317	330118	200	206	100 - 240
SET GLUEMATIC 3002	333393	n. a.	200	206	100 - 240

### GLUEMATIC 5000



- electronically controlled hot-melt glue
- applicator with a very high melting capacity for cordless glueing, including long and short nozzle

### SET GLUEMATIC 5000



- including standard and long nozzle and 8 glue sticks
- packed in PVC case

Model	Art. No.	Output (Watt)	Melt Temp. (°C)	Voltage
GLUEMATIC 5000	332716	500	210 - 220	220 - 240
SET GLUEMATIC 5000	332754	500	210 - 220	220 - 240

### GLUE STICKS



Glue Sticks suitable for a.m. models  
dia 11 mm, length 250 mm  
250 g / pack containing 10 pcs

Art. No.	Colour
006761	Transparent, ULTRA POWER
006754	Transparent, CRYSTAL
006792	Black
006808	White
006778	Wood Application

### Wireless Hot-Melt Glue Guns Neo 1 & Neo 2



NEO 1

NEO 2

- cordless operation with rechargeable lithium-ion battery 3,6 V
- incl. charging adapter with Schuko + Micro USB Plug
- run time up to 30 minutes
- automatic switch off
- warm up time less than 15 sec.
- NEW: gluing without dripping



Glue Sticks Neo  
dia 7 mm, length 150 mm  
suitable for different materials

Art. No.	Weight	Melt Temp. (°C)	Voltage
NEO 1 / 334109	155 gr.	170	100 - 240
NEO 2 / 334208	275 gr.	170	100 - 240

Art. No.	Colour
006624	Transparent, CRYSTAL 96g
006594	Transparent, CRYSTAL 240g

## Steel Collars



### Steel Collars for Light Pipes

- band size 16 x 1,2 mm
- thread M6
- bulk packing with 100 pcs.



### Nylon Plug VN with white zinc-plated screw

- For clamp CT
- bulk packing with 100 pcs.

Art. No.	Type	Thread	Plug mm	Hole dia. mm
768	VN V 8 x 40	M6	40	8

Art. No.	Type	pipes for (mm)
1402	CT14	14
1403	CT16	16
1404	CT18	18
1405	CT20	20
1406	CT22	22
1407	CT24	24
1408	CT26	26
1409	CT28	28
1410	CT32	32
1415	CT35	35
1411	CT38	38
1412	CT42	42
1413	CT48	48
1414	CT50	50



### Steel Collars Set

Containing steel collars, white zinc-plated screws, with wall plugs, blister packing

Art. No.	Type	pipes for (mm)	pieces / pack
3189	CTV 10.S	10	5 each
3190	CTV 12.S	12	5 each
3191	CTV 14.S	14	4 each
3192	CTV 16.S	16	4 each
3193	CTV 18.S	18	4 each
3194	CTV 20.S	20	4 each
3195	CTV 22.S	22	4 each
3196	CTV 24.S	24	4 each
3197	CTV 26.S	26	3 each
3198	CTV 28.S	28	3 each
3199	CTV 32.S	32	3 each
3202	CTV 38.S	38	2 each
3203	CTV 42.S	42	2 each

## Screws and Anchors



### Screws and Anchors Set

for brick and concrete

100 sets / carton

Art. No.	Size	Pieces / Set
280420/EGK	4 x 20mm	25 pieces
280525/EGK	5 x 25mm	20 pieces
280630/EGK	6 x 30mm	12 pieces
281840/EGK	8 x 40mm	8 pieces
281050/EGK	10 x 50mm	4 pieces
281260/EGK	12 x 60mm	2 pieces

**other compositions available on request**

## NH - Fuse Links



Type: 0



Type: 00



Type: 000



Type: 1



Type: 2



Type: 3

## Neozed & Bottle Fuses



Type: NDZ



Type: D I



Type: D II



Type: D III



Type: D IV



Type: D V

## Accessories



Fuse Caps



Fuse Bases



Fuse Bases



1 - pole  
230 / 400 V



2 - pole  
400 V



3 - pole  
400 V



4 - pole  
400 V

	Amp.	Poles	Art. No.	Poles	Art. No.	Poles	Art. No.	Poles	Art. No.
6 kA	6 Amp	1	PE 61 C6	2	PE 62 C6				
	10 Amp	1	PE 61 C10	2	PE 62 C10				
	16 Amp	1	PE 61 C16	2	PE 62 C16	3	PE 63 C16		
	20 Amp	1	PE 61 C20	2	PE 62 C20	3	PE 63 C20	4	PR 64 C20
	32 Amp	1	PE 61 C32	2	PE 62 C32	3	PE 63 C32	4	PR 64 C32
10 kA	16 Amp	1	PR 61 C16	2	PR 62 C16	3	PR 63 C16		
	20 Amp	1	PR 61 C20	2	PR 62 C20	3	PR 63 C20	4	PR 64 C20
	32 Amp	1	PR 61 C32	2	PR 62 C32	3	PR 63 C32	4	PR 64 C32
	40 Amp	1	PR 61 C40	2	PR 62 C40	3	PR 63 C40	4	PR 64 C40
	50 Amp	1	PR 61 C50	2	PR 62 C50	3	PR 63 C50	4	PR 64 C50
	63 Amp	1	PR 61 C63	2	PR 62 C63	3	PR 63 C63	4	PR 64 C63



2 pole PFB  
230 V



2 pole PCHB 2 (100 A)  
230 V



4 pole PFB  
400 V



4 pole PCHB (100 A)  
400 V

Amp		Poles	Art. No.	Poles	Art. No.
40 Amp	0.3 (300 mA)	2	PFB 2 40/0,3	4	PFB 4 40/0,3
40 Amp	0.03 (30 mA)	2	PFB 2 40/0,03	4	PFB 4 40/0,03
63 Amp	0.3 (300 mA)	2	PFB 2 63/0,3	4	PFB 4 63/0,3
63 Amp	0.03 (30 mA)	2	PFB 2 63/0,03	4	PFB 4 63/0,03
100 Amp	0.3 (300 mA)	2	PCHB 2 100/0,3	4	PCHB 4 100/0,3
100 Amp	0.03 (30 mA)	2	PCHB 2 100/0,03	4	PCHB 4 100/0,03



## Isolator Switches

Made in Slovakia



1 - pole



2 - pole



3 - pole

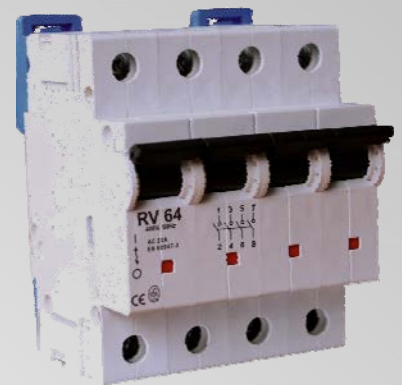

4 - pole

Amp.	Poles	Art. No.	Poles	Art. No.	Poles	Art. No.	Poles	Art. No.
10 Amp	1	RV 61 10	2	RV 62 10	3	RV 63 10	4	RV 64 10
16 Amp	1	RV 61 16	2	RV 62 16	3	RV 63 16	4	RV 64 16
25 Amp	1	RV 61 25	2	RV 62 25	3	RV 63 25	4	RV 64 25
32 Amp	1	RV 61 32	2	RV 62 32	3	RV 63 32	4	RV 64 32
40 Amp	1	RV 61 40	2	RV 62 40	3	RV 63 40	4	RV 64 40
63 Amp	1	RV 61 63	2	RV 62 63	3	RV 63 63	4	RV 64 63
125 Amp	1	RV 121 125	2	RV 122 125	3	RV 123 125	4	RV 124 125

## Accessories

Made in Slovakia



Signal Lamps RS Series  
1 - pole

Colour	Voltage	Voltage	Voltage	Voltage
White	24 V	110 V	48 V	230 V
Red	24 V	110 V	48 V	230 V
Blue	24 V	110 V	48 V	230 V
Green	24 V	110 V	48 V	230 V
Yellow	24 V	24 V	24 V	24 V



Undervoltage Trip PC

*suitable for protection against re-run  
-up of motor by failure in mains.*

*with signalisation of release  
position green / red*

Rated Voltage
24 V
48 V
120 V
230 V
400 V



Motor Protection Switches

*with thermal and magnetic  
short-circuit release*

*reliable protection especially at  
overloads and in certain cases  
also at short circuits*

Available operating currents (A)
2, 3, 5, 8, 12, 20, 33, 44, 75, 120, 160, 230, 270, 360, 400



### AlphaRex D21

Daily and weekly time switch

- 1 changeover contact
- 250 V/50 Hz, 16 A~ cos φ = 1
- 56 programs
- Shortest switching step: 1 s
- multi languages

Art. No.	Volt	Hz	Channels
4 126 31	230 V	50/60 Hz	1
4 126 41	230 V	50/60 Hz	2



### MicroRex D21/D22 Plus 2

Digital weekly time switch

- manual override
- running reserve of 3 years

Art. No.	Volt	Hz	Channels
603 770	230 V	50/60 Hz	1
603 771	230 V	50/60 Hz	2



### MicroRex QT31 - 3 Modules

Daily time switch

With quartz motor, +/- 2.5 s/day clock precision, 100 hour working reserve, Surface-mounting possible with a wall bracket and a terminal cover. Unit width: 3 modules of 17.5 mm each, 15 min switching increments, shortest switching step: 30 min

Art. No.	Volt	Hz
4 128 13 <i>(old 037 53)</i>	230 V	50/60 Hz



### MicroRex QT11 - 1 Module

With synchronous (mains-synchronised clock precision), +/- 2.5 s/day clock precision, 100 hour working reserve, unit width: 1 module of 17.5 mm, 15 min switching increments, shortest switching step: 15 min

Art. No.	Volt	Hz
4 127 90 <i>(old 037 40)</i>	230 V	50/60 Hz

### EconoRex MT

Time switch modules with flat plugs for

Art. No.	Volt	Hz
499 83	230 V	50 Hz

### Suitable Wall Mounting Kit

Includes base plate with terminal and terminal cover.

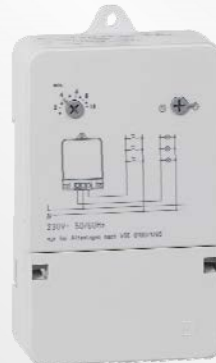
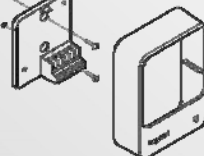

### Staircase Switches REX 600

modified version (electronic)

Art. No.	Volt	Hz
49 781	110/220 V	50/60 Hz



### PolarRex KKT

Defrost time switches without running reserve, 24 hour

Art. No. 499 26

Art. No.	Volt	Hz	Channels
499 26	230 V	50 Hz	2



### Multifunction Relay's

To control single timer functions like: illumination, ventilation, automation, signalisation, control systems e.g. Sealable cover, lexic design

*more details upon request*

Art. No.	Volt	Hz	Channels
047 44	8A / 250V	50/60 Hz	1





## Kilowatt Hour Meters

**KISTENMACHER** Kilowatt Hour Meters provide a measuring solution in the popular classic style. Other types and digital meters are available on request.

### Single Phase Active Kilowatt Hour Meters - DD28-Series:

for indoor wall installation.

Manufactured according to standards GB/T15283 and IEC 62053-11 for direct connection

Dimensions: 190 x 114 x 108 mm

Aluminium cover (plastic and glass covers are available on request)

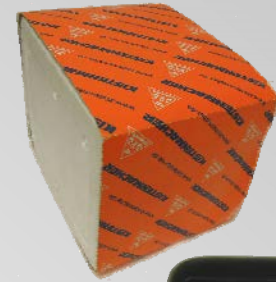

Art.-No.	Rated Current	Rated Voltage	Overload Capacity	Starting Current	Accuracy class	Pieces / carton
EGK DD28/3	3(12)A	220-230V 50/60 Hz.	400% lb	0.5% lb	2.0	12 pcs.
EGK DD28/5	5(20)A					
EGK DD28/10	10(40)A					
EGK DD28/15	15(60)A					
EGK DD28/30	20(80)A					



### Single Phase Active Kilowatt Hour Meters - DD862-Series:

Art.-No.	Rated Current	Rated Voltage	Overload Capacity	Starting Current	Accuracy class	Pieces / carton
EGK DD862/2,5	2,5(10)A	220-230V 50/60 Hz.	400-600% lb	0.5% lb	2.0	12 pcs.
EGK DD862/3	3(12)A					
EGK DD862/5	5(20)A					
EGK DD862/10	10(40)A					
EGK DD862/15	15(60)A					
EGK DD862/20	20(80)A					
EGK DD862/30	30(100)A					



### Three-Phase Active Kilowatt Hour Meters - DT862-Series:

for indoor wall installation.

Manufactured according to standards GB/T15283 and IEC 62053-11

for direct connection (versions for connection through current transformers are available on request).

Dimensions: 214 x 122 x 123 mm

Plastic cover (aluminium, bakelite and glass covers are available on request)

Art.-No.	Rated Current	Rated Voltage	Accuracy class	Pieces / carton
EGK DT862/5	3 x 5(20)A	3 x 220/380V 50/60 Hz.	2.0	12 pcs.
EGK DT862/10	3 x 10(40)A			
EGK DT862/15	3 x 15(60)A			
EGK DT862/20	3 x 20(80)A			
EGK DT862/30	3 x 30(100)A			



Reconditioned meters are also available under the following brands, upon your request:

**SIEMENS**

**AEG**

**Landis  
|Gyr+**

**TELTOW**

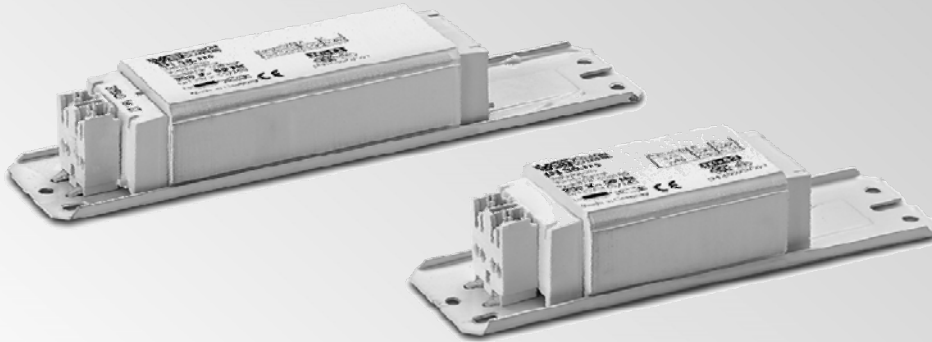

**5 - 18 W, 240/220 V**  
**shape: 28 x 41 mm**

**Compact Fluorescent**

Output W	Type	Base	Current mA	Type	Ref. No.	Voltage V, Hz	A mm	B mm	C mm	Weight kg	$\Delta t/\Delta t_{tan}$ K	Energy efficiency	C <sub>p</sub> $\mu F$	Current mA
-------------	------	------	---------------	------	----------	------------------	---------	---------	---------	--------------	--------------------------------	----------------------	---------------------------	---------------

**240 V, 50 Hz**

2x5	TC-S	G23	180	LN 13.413	<b>164342</b>	240, 50	85	75	34	0.32	60/85	B2	2.0	70
7	TC-S	G23	175	L7/9/11.411	<b>164335</b>	240, 50	85	75	34	0.32	60/85	B2	2.0	50
13	TC-D/TC-T	G24d-1/GX24d-1	175	LN 13.413	<b>164342</b>	240, 50	85	75	34	0.32	60/90	B1	2.0	100
18	TC-D/TC-T	G24d-2/GX24d-2	220	LN 18I.418	<b>164353</b>	240, 50	85	75	34	0.28	60/160	B1	2.0	110

**220 V, 60 Hz**

5	TC-S	G23	180	L7/9/11.207	<b>163305</b>	220, 60	85	75	34	0.32	35/65	-	2.0	70
13	TC-D/TC-T	G24d-1/GX24d-1	165	L 13.210	<b>520992</b>	220, 60	85	75	34	0.32	45/80	-	2.0	110

**15 - 75 W, 240/220 V**  
**shape: 28 x 41 mm**

**Fluorescent**

18/20	T-U	2G13	370	L 18.936 L 18.933	<b>534627</b> <b>534628</b>	240, 50	150	140	45	0.43	70/140	B2	4.5	120
36/40	T8 (T26)/ T12 (T38)	G13	430	L 36.124	<b>534292</b> <b>534584</b>	240, 50	150	140	60	0.55	55/140	B2	4.5	210
58/65	T8 (T26)/ T12 (T38)	G13	670	LN 58.722	<b>534252</b> <b>547701</b>	240, 50	190	180	92	0.80	60/180	B2	7.0	320
36/40	T8 (T26)/ T12 (T38)	G13	430	L36.124	<b>534292</b> <b>534584</b>	240, 50	150	140	45	0.43	65	-	4.5	210

**220 V, 60 Hz**

18/20	T8 (T26)/ T12 (T38)	G13	370	L 18.121	<b>532149</b> <b>528582</b> <b>529438</b>	220, 60	110 150	100 140	45 45	0.42 0.43	65/145	-	4.0	190
36/40	T8 (T26)/ T12 (T38)	G13	400	L 36.120	<b>509373</b> <b>529453</b>	220, 60	150	140	45	0.43	60/170	-	4.0	220
58/65	T8 (T26)/ T12 (T38)	G13	670	L 58.657	<b>164870</b> <b>529442</b>	220, 60	195	180	92	0.80	55/140	-	6.0	320

**black coloured = push-type terminal**

**blue coloured = screw-type terminal**

## Electronic Transformers



Type	Ref. No.	Capacity range (W)	Voltage (V) prim. ( $\pm 10\%$ )	sec.	Nominal current A	Ambient temperature $t_a$ ( $^{\circ}\text{C}$ )	Casing temperature $t_c$ ( $^{\circ}\text{C}$ )	Weight g
------	----------	--------------------	----------------------------------	------	-------------------	--	---	----------

### Dimensions: 22x36x103.5 mm

EST 60/12.635	<b>186215</b>	10-60	220-240	10.2-12	0.258-0.260	-20 to 45	max. 85	70
---------------	---------------	-------	---------	---------	-------------	-----------	---------	----

### Dimensions: 28x37x128 mm

EST 70/12.380	<b>186072</b>	20-70	230-240	11.3-11.7	0.30-0.31	-20 to 45	max. 70	85
EST 105/12.381	<b>186077</b>	20-105	230-240	11.2-11.7	0.435-0.445	-20 to 40	max. 85	95

### Dimensions: 33x37x185 mm

EST 150/12.622	<b>186098</b>	50-150	230-240	11.2-11.6	0.595-0.605	-20 to 45	max. 85	175
----------------	---------------	--------	---------	-----------	-------------	-----------	---------	-----

## Magnetic Transformers

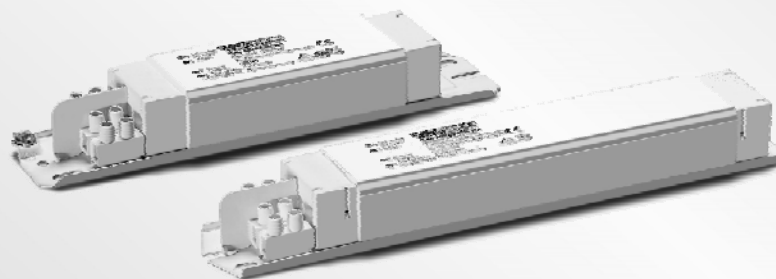

Type	Ref. No.	Capacity range (W)	50,60 Hz V prim.   V sec.	Ambient temperature $T_a$ ( $^{\circ}\text{C}$ )	A mm	B mm	C mm	Weight kg	AT
------	----------	--------------------	---------------------------	--	------	------	------	-----------	----

### 127 V / 60 Hz

STR 50/12.209	<b>525791</b>	35-50	127   11.5	40/F	155	140	63	0.55	0.500
---------------	---------------	-------	------------	------	-----	-----	----	------	-------

### 220 V / 50, 60 Hz

STR 50/12.207	<b>500843</b>	35-50	220   11.5	40/B	175	165	83	0.73	0.250
---------------	---------------	-------	------------	------	-----	-----	----	------	-------

### 240 V / 50, 60 Hz

STR 50/12.422	<b>502592</b>	35-50	220   11.5	40/B	175	165	83	0.73	0.250
---------------	---------------	-------	------------	------	-----	-----	----	------	-------

### 230 V / 50, 60 Hz

STR 50/12.311	<b>170002</b>	60-105	230	11.5	240	230	160	1.33	0.500
---------------	---------------	--------	-----	------	-----	-----	-----	------	-------



Lamps			Ballast						Capacitor		
Output W	Type	Current A	Type	Ref. No.	Voltage AC V, Hz	Weight kg	Δ t K	Power factor λ	CP μF	IN A	Pallet Unit
35	HS, HI	0.53	NaHJ 35.485	<b>526517</b>	220/230, 50	0.91	60	0.40	6	0.22/0.21	720 pcs
35	HS, HI	0.53	NaHJ 35.485	<b>161367</b>	230/240, 50	0.91	60	0.40	6	0.22/0.21	770 pcs
35	HS, HI	0.53	NaHJ 35.485	<b>161371</b>	220, 60	0.91	50	0.41	5	0.23	770 pcs
70	HS, HI	0.98	NaHJ 70.128	<b>539434</b>	230/240, 50	1.07	70/75	0.36	12	0.38/0.37	770 pcs
70	HS, HI	0.98	NaHJ 70.128	<b>538407</b>	240, 50	1.07	75	0.37	12	0.37	770 pcs
70	HS, HI	0.98	NaHJ 70.653	<b>161392</b>	220, 60	1.07	60	0.42	10	0.40	770 pcs
100	HS, HI	0.98	NaHJ 70.300	<b>174961</b>	220, 50	1.07	75	0.40	12	0.40	770 pcs
100	HS, HI	1.20	NaHJ 100.126	<b>507671</b>	220,50	1.24	75	0.44	12	0.55	770 pcs
100	HS, HI	1.20	NaHJ 100.941	<b>161707</b>	230/240, 50	1.24	75/80	0.42	12	0.55/0.53	540 pcs
100	HS, HI	1.20	NaHJ 100.271	<b>530195</b>	220, 60	1.24	75	0.45	10	0.57	770 pcs
150	HS, HI	1.80	NaHJ 150.620	<b>534540</b>	240, 50	1.80	75	0.40	20	0.74	462 pcs
150	HS, HI	1.80	NaHJ 150.679	<b>526196</b>	220, 60	1.55	75	0.44	16	0.80	462 pcs
150	HS, HI	1:80	NaHJ 150.159	<b>533602</b>	220, 50	1.80	75	0.41	20	0.80	462 pcs
250	HS, HI	3.00	NaHJ 250.204	<b>529087</b>	220, 50	2.50	80	0.42	32	1.32	396 pcs
250	HS, HI	3.00	NaHJ 250.340	<b>178177</b>	240, 50	2.84	80	0.39	32	1.21	330 pcs
250	HS, HI	3.00	NaHJ 250.163	<b>160604</b>	220, 60	2.50	70	0.42	25	1.35	330 pcs
400	HS, HI	4.45	NaHJ 400.743	<b>536143</b>	240, 50	4.1	75	0.40	45	1.85	240 pcs
400	HS, HI	4.45	NaHJ 400.743	<b>500402</b>	240, 50	5.20	75	0.43	45	1.90	147 pcs
400	HS, HI	4.45	NaHJ 400.744	<b>536144</b>	220, 60	4.1	70	0.44	40	2.05	240 pcs
400	HS, HI	4.45	NaHJ 400.743	<b>536142</b>	220, 50	4.1	70	0.45	45	2.10	240 pcs
600	HS	6.20	NaH 600.005	<b>533484</b>	230/240, 50	6.80	70	0.44	65	2.90/2.85	100 pcs
1000	HS HI	10.30 9.50	NaHJ 1000.089	<b>536140</b>	240, 50	8.90	85	0.42 0.46	100 85	4.8 4.9	105 pcs
1000	HS HI	10.30 9.50	NaHJ 1000.089	<b>528536</b>	220, 60	8.90	75 60	0.42 0.50	100 85	5.1 5.0	105 pcs
2000	HI	8.80	J 2000.71	<b>554303</b>	380/400, 50	15	75	0.60	37	6	50 pcs
2000	HI	8.8	J 2000.72	<b>554304</b>	380/400/415,50	14.0	70	0.50	37	6	50 pcs
2000	HI	10.3/11.3	JD 2000.82	<b>534306</b>	380/400/415,50	17.5	80	0.50	60	6	50 pcs
2000	HI	10.3/11.3	JD 2000.83	<b>554283</b>	380, 60	14.0	70	0.53	60	6	50 pcs
2000	HI	10.3/11,3	JD 2000.81	<b>554270</b>	380/400, 50	15	80	0,53	60	6	50 pcs

## Ballasts for High Pressure Mercury + Metal

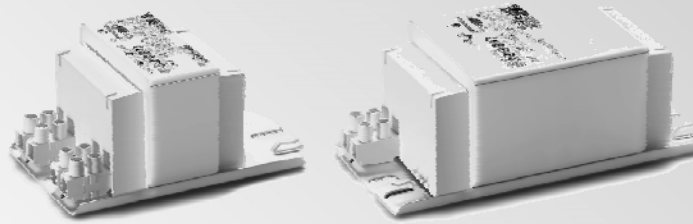

Lamps			Ballast						Capacitor		
Output W	Type	Current A	Type	Ref. No.	Voltage AC V, Hz	Weight kg	$\Delta t$ K	Power factor $\lambda$	CP $\mu F$	IN A	Pallet Unit
50	HM	0.61	Q 50.508	<b>167125</b>	240, 50	0.91	65	0.42	7	0.26	720 pcs
80	HM	0.80	Q 80.510	<b>167132</b>	240, 50	1.07	60	0.48	8	0.40	770 pcs
125	HM	1.15	Q 125.512	<b>167140</b>	240, 50	1.39	65	0.51	10	0.58	770 pcs
125	HM	1.15	Q 125.598	<b>502818</b>	220, 60	1.07	60	0.57	10	0.65	770 pcs
250	HM	2.13	Q 250.703	<b>508081</b>	240, 50	2.1	75	0.53	18	1.15	462 pcs
250	HM	2.13	Q 250.606	<b>533705</b>	220, 60	1.80	70	0.58	15	1.30	462 pcs.
400	HM	3.25	Q 400.669	<b>167374</b>	240, 50	2.88	75	0.54	25	1.85	330 pcs
400	HM	3.25	Q 400.613	<b>508245</b>	220, 60	2.50	75	0.60	25	2.00	330 pcs
1000	HM	7.50	Q 1000.145	<b>528886</b>	240, 50	6.90	75	0.58	60	4.60	126 pcs
1000	HM	7.50	Q 1000.311	<b>526715</b>	220, 60	6.90	70	0.61	50	5.0	126 pcs

## Ignitors for HS



Type	Ref. No.	Voltage AC 50-60 Hz V	Max. lamp current A	Internal loss W	Inherent heating K	Ignition voltage kV	Load capacity pF	Switch-off time sec./Hz	Weight g
------	----------	-----------------------	---------------------	-----------------	--------------------	---------------------	------------------	-------------------------	----------

### Plastic casing (PC)

Z 400 M K VS-Power	<b>142897</b>	220 - 240	5	< 3	< 35	4 - 5	20 - 50	-	130
--------------------	---------------	-----------	---	-----	------	-------	---------	---	-----

### Aluminium casing (Al)

Z 400 M VS-Power	<b>147707</b>	220 - 240	5	< 3	< 35	4 - 5	20 - 50	-	140
Z 1000 S	<b>140430</b>	220 - 240	12	< 6	< 35	4 - 5	20 - 100	-	340
Z 2000 S	<b>140432</b>	220 - 240	20	< 6	< 30	4 - 5	20 - 100	-	640
Z 2000 S / 400 V	<b>140497</b>	380 - 415	12	< 5	< 32	4 - 5	20 - 2000	-	340
Z 3500 S / 400 V	<b>140499</b>	380 - 415	20	< 7	< 35	4 - 5	20 - 100	-	650

## Parallel Capacitors

- Casing: plastic, white or aluminium
- Discharge resistance
- Fastening: male nipple (M8 x 10 mm) including nut and washer
- Temperature range: -40 to 85° C
- Push-in twin terminals: 0.5 - 1 sqmm
- Double spade connector 6.3 x 0.8 acc. to IEC 61210

Art. No.	Capacity $\mu\text{F}$	Voltage	Hz	Case	Terminal	Packing Unit
500302.05	4	250	50/60	Plastic	Push	450 pcs
500303.05	4,5	250	50/60	Plastic	Push	450 pcs
500305.05	6	250	50/60	Plastic	Push	450 pcs
508667.05	10	250	50/60	Plastic	Push	320 pcs
506366.05	12	250	50/60	Plastic	Push	260 pcs
500315.05	18	250	50/60	Plastic	Push	190 pcs
500316.88	20	250	50/60	Plastic	Push	80 pcs
500317.88	25	250	50/60	Plastic	Push	80 pcs
500318.88	30	250	50/60	Plastic	Push	100 pcs
500319.01	32	250	50/60	Alu	Push	50 pcs
500320.01	35	250	50/60	Alu	Push	36 pcs
500321.01	40	250	50/60	Alu	Push	36 pcs
536406.01	45	250	50/60	Alu	Push	36 pcs
500322.01	50	250	50/60	Alu	Push	32 pcs
500323.01	55	250	50/60	Alu	Push	32 pcs
536396.88	60	250	50/60	Alu	Push	49 pcs
536404.88	60	380-450V	50/60	Alu	Double Spade	36 pcs
536405.88	85	380-450V	50/60	Alu	Double Spade	36 pcs



**A** Push-in twin terminals 0.5 - 1 mm<sup>2</sup>

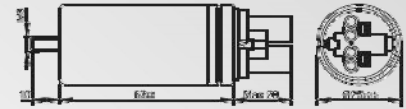

**B** Double spade connector 6.3x0.8 acc. to IEC 61210

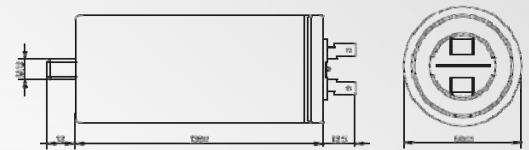

## Lampholders for Discharge Lamps



Further details available upon request

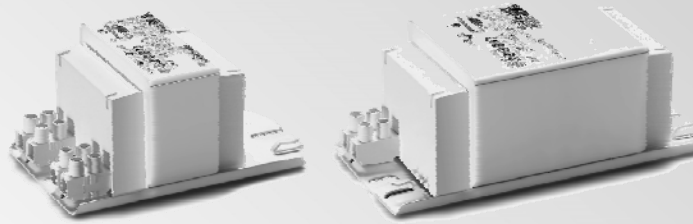

Lamps			Ballast						Capacitor		
Output W	Type	Current A	Type	Ref. No.	Voltage AC V, Hz	Weight kg	$\Delta t$ K	Power factor $\lambda$	CP $\mu F$	IN A	Pallet Unit
50	HM	0.61	Q 50.508	<b>167125</b>	240, 50	0.91	65	0.42	7	0.26	720 pcs
80	HM	0.80	Q 80.510	<b>167132</b>	240, 50	1.07	60	0.48	8	0.40	770 pcs
125	HM	1.15	Q 125.512	<b>167140</b>	240, 50	1.39	65	0.51	10	0.58	770 pcs
125	HM	1.15	Q 125.598	<b>502818</b>	220, 60	1.07	60	0.57	10	0.65	770 pcs
250	HM	2.13	Q 250.703	<b>508081</b>	240, 50	2.1	75	0.53	18	1.15	462 pcs
250	HM	2.13	Q 250.606	<b>533705</b>	220, 60	1.80	70	0.58	15	1.30	462 pcs.
400	HM	3.25	Q 400.669	<b>167374</b>	240, 50	2.88	75	0.54	25	1.85	330 pcs
400	HM	3.25	Q 400.613	<b>508245</b>	220, 60	2.50	75	0.60	25	2.00	330 pcs
1000	HM	7.50	Q 1000.145	<b>528886</b>	240, 50	6.90	75	0.58	60	4.60	126 pcs
1000	HM	7.50	Q 1000.311	<b>526715</b>	220, 60	6.90	70	0.61	50	5.0	126 pcs

## Ignitors for HS



Type	Ref. No.	Voltage AC 50-60 Hz V	Max. lamp current A	Internal loss W	Inherent heating K	Ignition voltage kV	Load capacity pF	Switch-off time sec./Hz	Weight g
------	----------	-----------------------	---------------------	-----------------	--------------------	---------------------	------------------	-------------------------	----------

### Plastic casing (PC)

Z 400 M K VS-Power	<b>142897</b>	220 - 240	5	< 3	< 35	4 - 5	20 - 50	-	130
--------------------	---------------	-----------	---	-----	------	-------	---------	---	-----

### Aluminium casing (Al)

Z 400 M VS-Power	<b>147707</b>	220 - 240	5	< 3	< 35	4 - 5	20 - 50	-	140
Z 1000 S	<b>140430</b>	220 - 240	12	< 6	< 35	4 - 5	20 - 100	-	340
Z 2000 S	<b>140432</b>	220 - 240	20	< 6	< 30	4 - 5	20 - 100	-	640
Z 2000 S / 400 V	<b>140497</b>	380 - 415	12	< 5	< 32	4 - 5	20 - 2000	-	340
Z 3500 S / 400 V	<b>140499</b>	380 - 415	20	< 7	< 35	4 - 5	20 - 100	-	650

## ELXc - Warm start for TC and T lamps



Output W	Type	Base	Power consumption W	Type	Ref. No.	Voltage AC 50, 60 Hz	Energy efficiency	Ambient Temp.	Casing Temp.	Size	Output W	Lumious factor %
<b>CFL Lamps</b>												
18	TC-DEL/-TEL	G24Q-2/GX24q-2	1 x 16.5	ELXc 218.871	<b>188699</b>	220-240	A2 BAT	-20 to 50	Max. 65	K2	21.0	104.8
2x18	TC-DEL/-TEL	G24Q-2/GX24q-2	2 x 16.5	ELXc 218.871	<b>188699</b>	220-240	A2 BAT	-20 to 50	Max. 65	K2	38.0	100.7
2x18	TC-F/-L	2G10/2G11	2 x 16.0	ELXc 142.872	<b>188700</b>	220-240	A2 BAT	-20 to 50	Max. 65	K2	34.0	98.0
22	T-R5	2GX13	1 x 22.0	ELXc 142.872	<b>188700</b>	220-240	A2 BAT	-20 to 50	Max. 65	K2	26.0	103.0
22+40	T-R5	2GX13	1 x 22+40	ELXc 242.837	<b>188643</b>	220-240	A2 BAT	-20 to 50	Max. 65	K3	68.0	100.0
2x22	T-R5	2GX13	1 x 22.0	ELXc 242.837	<b>188643</b>	220-240	A2 BAT	-20 to 50	Max. 65	K2	48.5	105.8
24	TC-F/-L	2G10/2G11	1 x 22.0	ELXc 142.872	<b>188700</b>	220-240	A2 BAT	-20 to 50	Max 65	K2	27.0	105.0
2x24	TC-F/-L	2G10/2G11	2 x 22.0	ELXc 242.837	<b>188643</b>	220-240	A2 BAT	-20 to 50	Max 65	K3	48.5	106.2
2x24	TC-F/-L	2G10/2G11	2 x 22.0	ELXc 142.872	<b>188700</b>	220-240	A2 BAT	-20 to 50	Max 65	K2	47.0	102.0
26	TC-DEL/-TEL	G24q-3/GX24q-3	1 x 24.0	ELXc 142.872	<b>188700</b>	220-240	A2 BAT	-20 to 50	Max 65	K2	26.0	104.0
2x26	TC-DEL/-TEL	G24q-3/GX24q-3	2 x 24.0	ELXc 142.872	<b>188700</b>	220-240	A2 BAT	-20 to 50	Max 65	K2	53.0	105.0
2x26	TC-DEL/-TEL	G24q-3/GX24q-3	2 x 24.0	ELXc 226.878	<b>183040</b>	220-240	A2 BAT	-20 to 50	Max 65	K2.1	50.0	101.0

## Various Comfort Line LED Drivers



33-85 W / for office



10-45 W / for retail shoplight



12-60 W / for residential shoplight



75-150 W / for streetlight



50-230 W / for industry

Further details available upon request





## Halogen



## Fluorescent



## High Pressure (Metal Halide, Sodium, Mercury)



**Radium**



**NARVA**

**SYLVANIA**

**OSRAM**



**PHILIPS**

## LED Lamps

**KISTENMACHER** offers a completely new line of LED lamps for direct replacement of conventional lighting solutions. The consistent use of high-grade components ensure a long lifetime of the lamps.

### LED Spotlight GU10 (extra-wide lens) / diffusing front cover

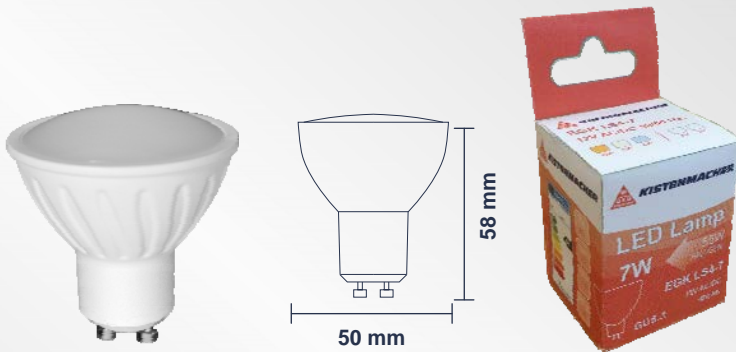

- Ceramic / plastic housing
- GU10 base
- Input: AC100-240V - 50/60 Hz.
- Power Factor: >0,50

Art.-No.	Wattage	Luminous Flux	Colour Temp.	CRI	Beam Angle
EGK LS1-3-WW-120	3W	240 lm	3000K	Ra >80	120°
EGK LS1-3-NW-120	3W	240 lm	4000K	Ra >80	120°
EGK LS1-3-DL-120	3W	240 lm	6000K	Ra >80	120°
EGK LS1-4.5-WW-120	4,5W	300 lm	3000K	Ra >80	120°
EGK LS1-4.5-NW-120	4,5W	300 lm	4000K	Ra >80	120°
EGK LS1-4.5-DL-120	4,5W	300 lm	6000K	Ra >80	120°
EGK LS1-5-WW-120	5W	410 lm	3000K	Ra >80	120°
EGK LS1-5-NW-120	5W	410 lm	4000K	Ra >80	120°
EGK LS1-5-DL-120	5W	410 lm	6000K	Ra >80	120°
EGK LS1-6-WW-120	6W	480 lm	3000K	Ra >80	120°
EGK LS1-6-NW-120	6W	480 lm	4000K	Ra >80	120°
EGK LS1-6-DL-120	6W	480 lm	6000K	Ra >80	120°
EGK LS1-7-WW-120	7W	550 lm	3000K	Ra >80	120°
EGK LS1-7-NW-120	7W	550 lm	4000K	Ra >80	120°
EGK LS1-7-DL-120	7W	550 lm	6000K	Ra >80	120°

## LED Lamps

**KISTENMACHER** offers a completely new line of LED lamps for direct replacement of conventional lighting solutions. The consistent use of high-grade components ensure a long lifetime of the lamps.

### LED Spotlight GU10 (narrow / wide lens) / Prismatic front cover

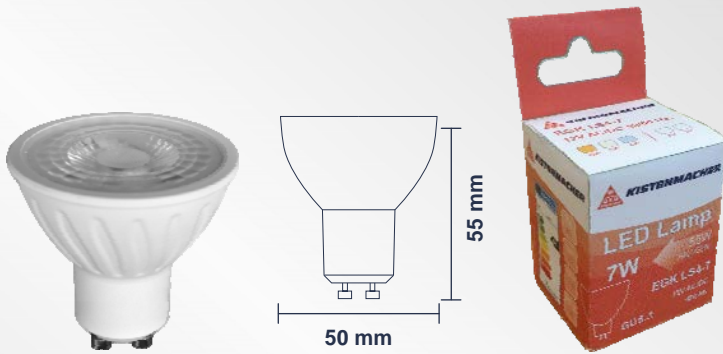

- Ceramic / plastic housing
- Prismatic front cover
- GU10 base
- Input: AC100-240V - 50/60 Hz.
- Power Factor: >0,50

Art.-No.	Wattage	Luminous Flux	Colour Temp.	CRI	Beam Angle
EGK LS2-3-WW-38	3W	240 lm	3000K	Ra >80	38°
EGK LS2-3-NW-38	3W	240 lm	4000K	Ra >80	38°
EGK LS2-3-DL-38	3W	240 lm	6000K	Ra >80	38°
EGK LS2-3-WW-60	3W	240 lm	3000K	Ra >80	60°
EGK LS2-3-NW-60	3W	240 lm	4000K	Ra >80	60°
EGK LS2-3-DL-60	3W	240 lm	6000K	Ra >80	60°
EGK LS2-5-WW-38	5W	400 lm	3000K	Ra >80	38°
EGK LS2-5-NW-38	5W	400 lm	4000K	Ra >80	38°
EGK LS2-5-DL-38	5W	400 lm	6000K	Ra >80	38°
EGK LS2-5-WW-60	5W	400 lm	3000K	Ra >80	60°
EGK LS2-5-NW-60	5W	400 lm	4000K	Ra >80	60°
EGK LS2-5-DL-60	5W	400 lm	6000K	Ra >80	60°
EGK LS2-7-WW-38	7W	500 lm	3000K	Ra >80	38°
EGK LS2-7-NW-38	7W	500 lm	4000K	Ra >80	38°
EGK LS2-7-DL-38	7W	500 lm	6000K	Ra >80	38°
EGK LS2-7-WW-60	7W	500 lm	3000K	Ra >80	60°
EGK LS2-7-NW-60	7W	500 lm	4000K	Ra >80	60°
EGK LS2-7-DL-60	7W	500 lm	6000K	Ra >80	60°

## LED Lamps

**KISTENMACHER** offers a completely new line of LED lamps for direct replacement of conventional lighting solutions. The consistent use of high-grade components ensure a long lifetime of the lamps.

### LED Spotlight GU5.3 (extra-wide lens) / Diffusing front cover



- Ceramic / plastic housing
- Diffusing front cover
- GU5.3 base
- Input: 12V AC/DC - 50/60 Hz.
- Power Factor: >0,50

Art.-No.	Wattage	Luminous Flux	Colour Temp.	CRI	Beam Angle
EGK LS3-3-WW-120	3W	240 lm	3000K	Ra >80	120°
EGK LS3-3-NW-120	3W	240 lm	4000K	Ra >80	120°
EGK LS3-3-DL-120	3W	240 lm	6000K	Ra >80	120°
EGK LS3-4.5-WW-120	4,5W	300 lm	3000K	Ra >80	120°
EGK LS3-4.5-NW-120	4,5W	300 lm	4000K	Ra >80	120°
EGK LS3-4.5-DL-120	4,5W	300 lm	6000K	Ra >80	120°
EGK LS3-5-WW-120	5W	410 lm	3000K	Ra >80	120°
EGK LS3-5-NW-120	5W	410 lm	4000K	Ra >80	120°
EGK LS3-5-DL-120	5W	410 lm	6000K	Ra >80	120°
EGK LS3-6-WW-120	6W	480 lm	3000K	Ra >80	120°
EGK LS3-6-NW-120	6W	480 lm	4000K	Ra >80	120°
EGK LS3-6-DL-120	6W	480 lm	6000K	Ra >80	120°
EGK LS3-7-WW-120	7W	550 lm	3000K	Ra >80	120°
EGK LS3-7-NW-120	7W	550 lm	4000K	Ra >80	120°
EGK LS3-7-DL-120	7W	550 lm	6000K	Ra >80	120°

## LED Lamps

**KISTENMACHER** offers a completely new line of LED lamps for direct replacement of conventional lighting solutions. The consistent use of high-grade components ensure a long lifetime of the lamps.

### LED Spotlight GU5.3 (narrow / wide lens) / Prismatic Front Cover



- Ceramic / plastic housing
- Prismatic front cover
- GU5.3 base
- Input: 12V AC/DC - 50/60 Hz.
- Power Factor: >0,50

Art.-No.	Wattage	Luminous Flux	Colour Temp.	CRI	Beam Angle
EGK LS4-3-WW-38	3W	240 lm	3000K	Ra >80	38°
EGK LS4-3-NW-38	3W	240 lm	4000K	Ra >80	38°
EGK LS4-3-DL-38	3W	240 lm	6000K	Ra >80	38°
EGK LS4-3-WW-60	3W	240 lm	3000K	Ra >80	60°
EGK LS4-3-NW-60	3W	240 lm	4000K	Ra >80	60°
EGK LS4-3-DL-60	3W	240 lm	6000K	Ra >80	60°
EGK LS4-5-WW-38	5W	400 lm	3000K	Ra >80	38°
EGK LS4-5-NW-38	5W	400 lm	4000K	Ra >80	38°
EGK LS4-5-DL-38	5W	400 lm	6000K	Ra >80	38°
EGK LS4-5-WW-60	5W	400 lm	3000K	Ra >80	60°
EGK LS4-5-NW-60	5W	400 lm	4000K	Ra >80	60°
EGK LS4-5-DL-60	5W	400 lm	6000K	Ra >80	60°
EGK LS4-7-WW-38	7W	500 lm	3000K	Ra >80	38°
EGK LS4-7-NW-38	7W	500 lm	4000K	Ra >80	38°
EGK LS4-7-DL-38	7W	500 lm	6000K	Ra >80	38°
EGK LS4-7-WW-60	7W	500 lm	3000K	Ra >80	60°
EGK LS4-7-NW-60	7W	500 lm	4000K	Ra >80	60°
EGK LS4-7-DL-60	7W	500 lm	6000K	Ra >80	60°

## LED Lamps

**KISTENMACHER** offers a completely new line of LED lamps for direct replacement of conventional lighting solutions. The consistent use of high-grade components ensure a long lifetime of the lamps.

### LED Spotlight GU5.3 (extra-wide lens) - direct connection / Diffusing front cover



- Ceramic / plastic housing
- Diffusing front cover
- GU5.3 base
- Input: AC100-240V - 50/60 Hz.
- Power Factor: >0,50

Art.-No.	Wattage	Luminous Flux	Colour Temp.	CRI	Beam Angle
EGK LS5-3-WW-120	3W	240 lm	3000K	Ra >80	120°
EGK LS5-3-NW-120	3W	240 lm	4000K	Ra >80	120°
EGK LS5-3-DL-120	3W	240 lm	6000K	Ra >80	120°
EGK LS5-4.5-WW-120	4,5W	300 lm	3000K	Ra >80	120°
EGK LS5-4.5-NW-120	4,5W	300 lm	4000K	Ra >80	120°
EGK LS5-4.5-DL-120	4,5W	300 lm	6000K	Ra >80	120°
EGK LS5-5-WW-120	5W	410 lm	3000K	Ra >80	120°
EGK LS5-5-NW-120	5W	410 lm	4000K	Ra >80	120°
EGK LS5-5-DL-120	5W	410 lm	6000K	Ra >80	120°
EGK LS5-6-WW-120	6W	480 lm	3000K	Ra >80	120°
EGK LS5-6-NW-120	6W	480 lm	4000K	Ra >80	120°
EGK LS5-6-DL-120	6W	480 lm	6000K	Ra >80	120°
EGK LS5-7-WW-120	7W	550 lm	3000K	Ra >80	120°
EGK LS5-7-NW-120	7W	550 lm	4000K	Ra >80	120°
EGK LS5-7-DL-120	7W	550 lm	6000K	Ra >80	120°

## LED Lamps

**KISTENMACHER** offers a completely new line of LED lamps for direct replacement of conventional lighting solutions. The consistent use of high-grade components ensure a long lifetime of the lamps.

### LED Spotlight GU5.3 (extra-wide lens) - direct connection / Prismatic front cover

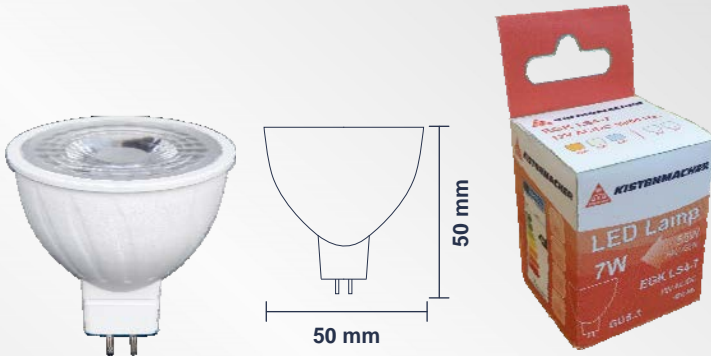

- Ceramic / plastic housing
- Prismatic front cover
- GU5.3 base
- Input: AC100-240V - 50/60 Hz.
- Power Factor: >0,50

Art.-No.	Wattage	Luminous Flux	Colour Temp.	CRI	Beam Angle
EGK LS6-3-WW-38	3W	240 lm	3000K	Ra >80	38°
EGK LS6-3-NW-38	3W	240 lm	4000K	Ra >80	38°
EGK LS6-3-DL-38	3W	240 lm	6000K	Ra >80	38°
EGK LS6-3-WW-60	3W	240 lm	3000K	Ra >80	60°
EGK LS6-3-NW-60	3W	240 lm	4000K	Ra >80	60°
EGK LS6-3-DL-60	3W	240 lm	6000K	Ra >80	60°
EGK LS6-5-WW-38	5W	400 lm	3000K	Ra >80	38°
EGK LS6-5-NW-38	5W	400 lm	4000K	Ra >80	38°
EGK LS6-5-DL-38	5W	400 lm	6000K	Ra >80	38°
EGK LS6-5-WW-60	5W	400 lm	3000K	Ra >80	60°
EGK LS6-5-NW-60	5W	400 lm	4000K	Ra >80	60°
EGK LS6-5-DL-60	5W	400 lm	6000K	Ra >80	60°
EGK LS6-7-WW-38	7W	500 lm	3000K	Ra >80	38°
EGK LS6-7-NW-38	7W	500 lm	4000K	Ra >80	38°
EGK LS6-7-DL-38	7W	500 lm	6000K	Ra >80	38°
EGK LS6-7-WW-60	7W	500 lm	3000K	Ra >80	60°
EGK LS6-7-NW-60	7W	500 lm	4000K	Ra >80	60°
EGK LS6-7-DL-60	7W	500 lm	6000K	Ra >80	60°

## LED Lamps

**KISTENMACHER** offers a completely new line of LED lamps for direct replacement of conventional lighting solutions. The consistent use of high-grade components ensure a long lifetime of the lamps.

### LED Candle Style Lamps

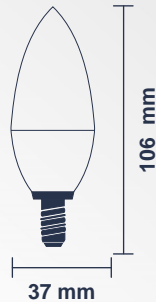

- Ceramic / plastic housing
- E27 / E14 bases
- Input: AC100-240V - 50/60 Hz.
- Power Factor: >0,50

Art.-No.	Wattage	Luminous Flux	Colour Temp.	CRI	Beam Angle	Base
EGK LC1-3-WW-E14	3W	240 lm	3000K	Ra >80	160°	E14
EGK LC1-3-NW-E14	3W	240 lm	4000K	Ra >80	160°	E14
EGK LC1-3-DL-E14	3W	240 lm	6000K	Ra >80	160°	E14
EGK LC1-3-WW-E27	3W	240 lm	3000K	Ra >80	160°	E27
EGK LC1-3-NW-E27	3W	240 lm	4000K	Ra >80	160°	E27
EGK LC1-3-DL-E27	3W	240 lm	6000K	Ra >80	160°	E27
EGK LC1-5-WW-E14	5W	410 lm	3000K	Ra >80	160°	E14
EGK LC1-5-NW-E14	5W	410 lm	4000K	Ra >80	160°	E14
EGK LC1-5-DL-E14	5W	410 lm	6000K	Ra >80	160°	E14
EGK LC1-5-WW-E27	5W	410 lm	3000K	Ra >80	160°	E27
EGK LC1-5-NW-E27	5W	410 lm	4000K	Ra >80	160°	E27
EGK LC1-5-DL-E27	5W	410 lm	6000K	Ra >80	160°	E27
EGK LC1-6-WW-E14	6W	500 lm	3000K	Ra >80	160°	E14
EGK LC1-6-NW-E14	6W	500 lm	4000K	Ra >80	160°	E14
EGK LC1-6-DL-E14	6W	500 lm	6000K	Ra >80	160°	E14
EGK LC1-6-WW-E27	6W	500 lm	3000K	Ra >80	160°	E27
EGK LC1-6-NW-E27	6W	500 lm	4000K	Ra >80	160°	E27
EGK LC1-6-DL-E27	6W	500 lm	6000K	Ra >80	160°	E24



## LED Lamps

**KISTENMACHER** offers a completely new line of LED lamps for direct replacement of conventional lighting solutions. The consistent use of high-grade components ensure a long lifetime of the lamps.

### LED Bulb Style Lamps

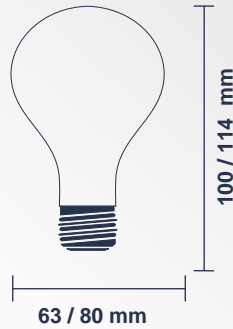

- Real glass / plastic housing
- E27 base (B22 on request)
- Input: AC170-240V - 50/60 Hz.
- Power Factor: >0,50

Art.-No.	Wattage	Luminous Flux	Colour Temp.	CRI	Beam Angle
EGK LB1-10-WW-E27	10W	900 lm	3000K	Ra >80	180°
EGK LB1-10-NW-E27	10W	900 lm	4000K	Ra >80	180°
EGK LB1-10-DL-E27	10W	900 lm	6500K	Ra >80	180°
EGK LB1-12-WW-E27	12W	1000 lm	3000K	Ra >80	180°
EGK LB1-12-NW-E27	12W	1000 lm	4000K	Ra >80	180°
EGK LB1-12-DL-E27	12W	1000 lm	6500K	Ra >80	180°

### LED Bulb Style Lamps (Full Glass)

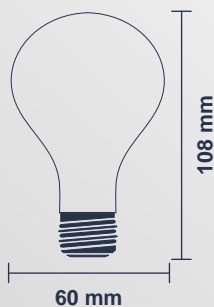

- Full real glass housing
- 100% look of conventional GLS lamp
- E27 base (B22 on request)
- Input: AC220-240V - 50/60 Hz.
- Power Factor: >0,50

Art.-No.	Wattage	Luminous Flux	Colour Temp.	CRI	Beam Angle
EGK LB2-8-WW-E27	8W	800 lm	3000K	Ra >80	360°
EGK LB2-8-NW-E27	8W	800 lm	4000K	Ra >80	360°
EGK LB2-8-DL-E27	8W	800 lm	6500K	Ra >80	360°

## LED Lamps

**KISTENMACHER** offers a completely new line of LED lamps for direct replacement of conventional lighting solutions. The consistent use of high-grade components ensure a long lifetime of the lamps.

### LED R-Style Lamps

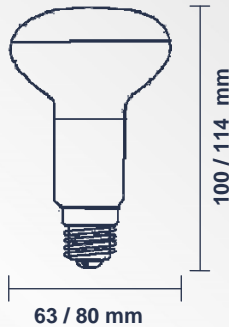

- Frosted plastic diffusor
- Aluminum / Plastic housing
- E27 base
- Input: AC175-250V - 50/60 Hz.
- Power Factor: >0,50

Art.-No.	Wattage	Luminous Flux	Colour Temp.	CRI	Beam Angle	Size Ø
EGK LR1-10-WW E27	10W	800 lm	3000K	Ra >80	120°	63 mm
EGK LR1-10-NW E27	10W	800 lm	4000K	Ra >80	120°	63 mm
EGK LR1-10-NW E27	10W	800 lm	6500K	Ra >80	120°	63 mm
EGK LR2-12-WW E27	12W	960 lm	3000K	Ra >80	120°	80 mm
EGK LR2-12-NW E27	12W	960 lm	4000K	Ra >80	120°	80 mm
EGK LR2-12-DL E27	12W	960 lm	6500K	Ra >80	120°	80 mm

### LED Globe Style Lamps

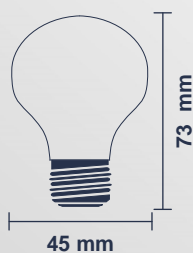

- Frosted plastic diffusor
- Plastic housing
- E27 base
- Input: AC170-240V - 50/60 Hz.
- Power Factor: >0,50

Art.-No.	Wattage	Luminous Flux	Colour Temp.	CRI	Beam Angle
EGK LG1-5-WW-E27	5W	400 lm	3000K	Ra >80	220°
EGK LG1-5-NW-E27	5W	400 lm	4000K	Ra >80	220°
EGK LG1-5-DL-E27	5W	400 lm	6500K	Ra >80	220°
EGK LG1-7-WW-E27	7W	550 lm	3000K	Ra >80	220°
EGK LG1-7-NW-E27	7W	550 lm	4000K	Ra >80	220°
EGK LG1-7-DL-E27	7W	550 lm	6500K	Ra >80	220°



## Incandescent Lamps

**KISTENMACHER** general lighting service (GLS) lamps.

These lamps are available on different versions from 127V-240V.

### Incandescent Lamps (lifetime abt. 1000 hrs.):



Art-No.	Output	Bulb Finish	Light Output (approx.)	Diameter	Base	Packing (pcs. / carton)
EGK G040W CL	40W	Clear	300 lm	60 mm	B22 / E27	100 pcs.
EGK G040W FR	40W	Frosted	290 lm	60 mm	B22 / E27	100 pcs.
EGK G060W CL	60W	Clear	530 lm	60 mm	B22 / E27	100 pcs.
EGK G060W FR	60W	Frosted	520 lm	60 mm	B22 / E27	100 pcs.
EGK G075W CL	75W	Clear	800 lm	60 mm	B22 / E27	100 pcs.
EGK G075W FR	75W	Frosted	780 lm	60 mm	B22 / E27	100 pcs.
EGK G100W CL	100W	Clear	1090 lm	60 mm	B22 / E27	100 pcs.
EGK G100W FR	100W	Frosted	1070 lm	60 mm	B22 / E27	100 pcs.
EGK G150W CL	150W	Clear	1800 lm	75 mm	B22 / E27	50 pcs.
EGK G150W FR	150W	Frosted	1780 lm	75 mm	B22 / E27	50 pcs.
EGK G200W CL	200W	Clear	2600 lm	75 mm	B22 / E27	50 pcs.
EGK G200W FR	200W	Frosted	2560 lm	75 mm	B22 / E27	50 pcs.

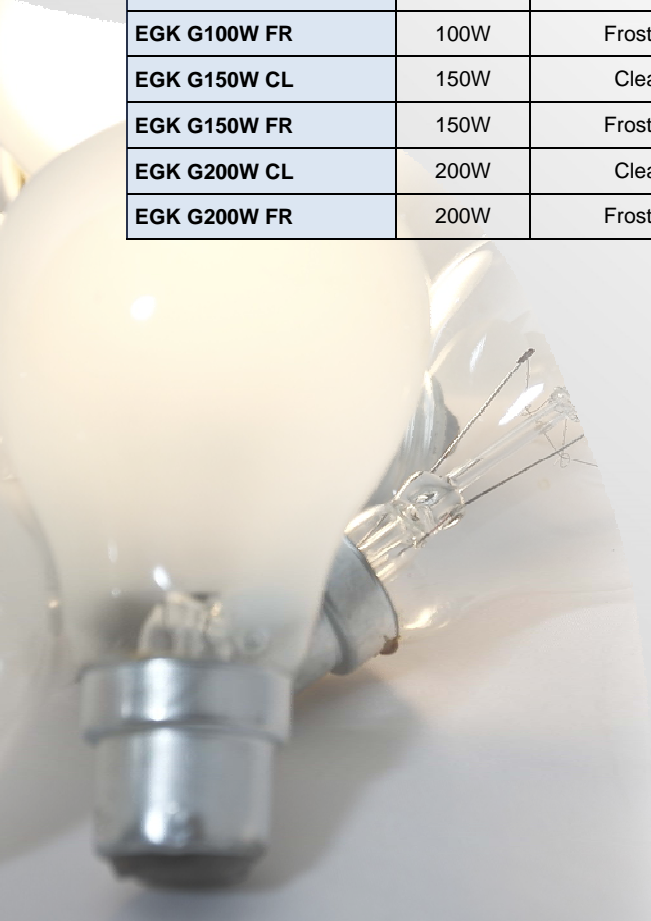



## Fluorescent Tubular Lamps

Over many years **KISTENMACHER** standard fluorescent tubes have gained an excellent reputation for quality and durability with our customers throughout the Middle East.

The lamps are available in all standard light colours and are suitable for a wide range of luminaires.

### T8 Standard Colours (26 mm diameter - lifetime abt. 8000 hrs.):



Art-No.	Output	Colour Temperature	Light Colour	Rendering Index	Base	Packing (pcs. / carton)
EGK TLD 10W/Incandescent	10W	2700K	Incandescent	70 R <sub>a</sub>	G13	25 pcs.
EGK TLD 10W/Warmwhite	10W	3000K	Warm White	70 R <sub>a</sub>	G13	25 pcs.
EGK TLD 10W/Coolwhite	10W	4000K	Cool White	70 R <sub>a</sub>	G13	25 pcs.
EGK TLD 10W/Daylight	10W	6500K	Daylight	70 R <sub>a</sub>	G13	25 pcs.
EGK TLD 15W/Incandescent	15W	2700K	Incandescent	70 R <sub>a</sub>	G13	25 pcs.
EGK TLD 15W/Warmwhite	15W	3000K	Warm White	70 R <sub>a</sub>	G13	25 pcs.
EGK TLD 15W/Coolwhite	15W	4000K	Cool White	70 R <sub>a</sub>	G13	25 pcs.
EGK TLD 15W/Daylight	15W	6500K	Daylight	70 R <sub>a</sub>	G13	25 pcs.
EGK TLD 18W/Incandescent	18W	2700K	Incandescent	70 R <sub>a</sub>	G13	25 pcs.
EGK TLD 18W/Warmwhite	18W	3000K	Warm White	70 R <sub>a</sub>	G13	25 pcs.
EGK TLD 18W/Coolwhite	18W	4000K	Cool White	70 R <sub>a</sub>	G13	25 pcs.
EGK TLD 18W/Daylight	18W	6500K	Daylight	70 R <sub>a</sub>	G13	25 pcs.
EGK TLD 18W/SuperDaylight	18W	12000K	SuperDaylight	70 R <sub>a</sub>	G13	25 pcs.
EGK TLD 36W/Incandescent	36W	2700K	Incandescent	70 R <sub>a</sub>	G13	25 pcs.
EGK TLD 36W/Warmwhite	36W	3000K	Warm White	70 R <sub>a</sub>	G13	25 pcs.
EGK TLD 36W/Coolwhite	36W	4000K	Cool White	70 R <sub>a</sub>	G13	25 pcs.
EGK TLD 36W/Daylight	36W	6500K	Daylight	70 R <sub>a</sub>	G13	25 pcs.
EGK TLD 36W/SuperDaylight	36W	12000K	SuperDaylight	70 R <sub>a</sub>	G13	25 pcs.

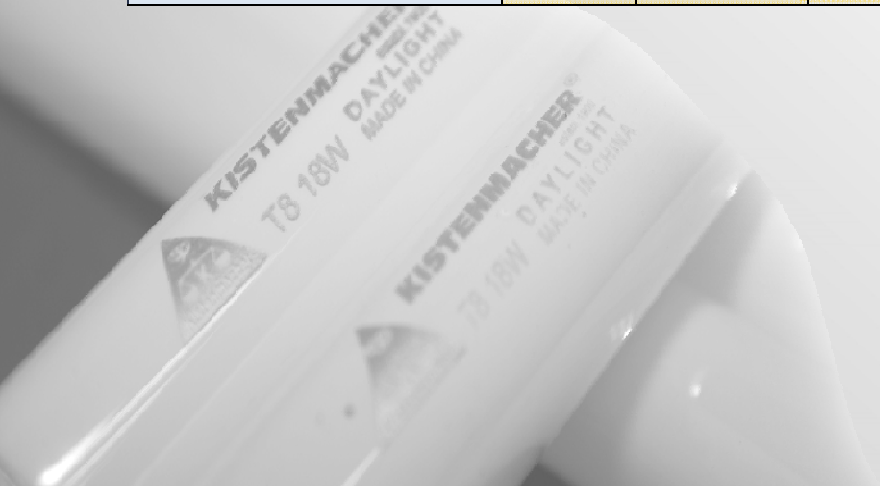

## Fluorescent Tubular Lamps

Over many years **KISTENMACHER** standard fluorescent tubes have gained an excellent reputation for quality and durability with our customers throughout the Middle East.

These lamps provide lighting in four different colour tones which makes the lamps ideally suitable for decoration in domestic and professional applications.

### T8 Coloured Lamps (26 mm diameter - lifetime abt. 8000 hrs.):



Art-No.	Output	Colour Method	Light Colour	Base	Packing (pcs. / carton)
EGK TLD18W/Red	18W	coloured fluorescent powder	Red	G13	25 pcs.
EGK TLD18W/Blue	18W		Blue	G13	25 pcs.
EGK TLD18W/Green	18W		Green	G13	25 pcs.
EGK TLD18W/Yellow	18W		Yellow	G13	25 pcs.
EGK TLD 36W/Red	36W		Red	G13	25 pcs.
EGK TLD 36W/Blue	36W		Blue	G13	25 pcs.
EGK TLD 36W/Green	36W		Green	G13	25 pcs.
EGK TLD 36W/Yellow	36W		Yellow	G13	25 pcs.
EGK TLD 36W/Tri-color	36W		B / R / G	G13	25 pcs.
EGK TLD18W/Red	18W	coloured glass	Red	G13	25 pcs.
EGK TLD18W/Blue	18W		Blue	G13	25 pcs.
EGK TLD18W/Green	18W		Green	G13	25 pcs.
EGK TLD18W/Yellow	18W		Yellow	G13	25 pcs.
EGK TLD 36W/Red	36W		Red	G13	25 pcs.
EGK TLD 36W/Blue	36W		Blue	G13	25 pcs.
EGK TLD 36W/Green	36W		Green	G13	25 pcs.
EGK TLD 36W/Yellow	36W		Yellow	G13	25 pcs.

### T8 UV Blacklight Blue Lamps (26 mm diameter - lifetime abt. 6000 hrs.):

Art-No.	Output	Wave Length	Light Colour	Base	Packing (pcs. / carton)
EGK TLD18W/BLB	18W	365 nm peak	UV BLB	G13	25 pcs.
EGK TLD36W/BLB	36W	365 nm peak	UV BLB	G13	25 pcs.

## LED Tubes

**KISTENMACHER** offers a new range of T8 style LED lamps for direct retrofit of conventional fluorescent T8 lamps. Connection can be made directly to the mains or via a pre-installed magnetic ballast (without fluorescent starter).

### LED T8 Style Tubular Lamps



- Real glass / plastic caps design
- G13 bases to replace conventional T8 lamps
- Input: AC85-265V - 50/60 Hz.
- Power Factor: >0,90
- Diameter: 26 mm (glass) / 28 mm (cap)

Art.-No.	Size	Wattage	Luminous Flux	Colour Temp.	CRI	LED Config
EGK TL-LED1/9W/WW	600 mm	9W	>90 lm/W	3000K	Ra >80	44 x SMD5730
EGK TL-LED1/9W/NW	600 mm	9W	>90 lm/W	4000K	Ra >80	44 x SMD5730
EGK TL-LED1/9W/DL	600 mm	9W	>90 lm/W	6500K	Ra >80	44 x SMD5730
EGK TL-LED1/15W/WW	900 mm	15W	>90 lm/W	3000K	Ra >80	68 x SMD5730
EGK TL-LED1/15W/NW	900 mm	15W	>90 lm/W	4000K	Ra >80	68 x SMD5730
EGK TL-LED1/15W/DL	900 mm	15W	>90 lm/W	6500K	Ra >80	68 x SMD5730
EGK TL-LED1/18W/WW	1200 mm	18W	>90 lm/W	3000K	Ra >80	72 x SMD5730
EGK TL-LED1/18W/NW	1200 mm	18W	>90 lm/W	4000K	Ra >80	72 x SMD5730
EGK TL-LED1/18W/DL	1200 mm	18W	>90 lm/W	6500K	Ra >80	72 x SMD5730
EGK TL-LED1/24W/WW	1500 mm	24W	>90 lm/W	3000K	Ra >80	102 x SMD5730
EGK TL-LED1/24W/NW	1500 mm	24W	>90 lm/W	4000K	Ra >80	102 x SMD5730
EGK TL-LED1/24W/DL	1500 mm	24W	>90 lm/W	6500K	Ra >80	102 x SMD5730



LED T8		Fluorescent T8
9W	←	18W
15W	←	30W
18W	←	36W
24W	←	58W

### Single-Lamp Holder



0607/1

### Set with press switch and contact fuse



0610 K / D / 1



0611 K / D / 1



0656 K / D

Art. No.	Watt	Length tube	Dimension	Fitting
0607 / 1	35 / 60 / 120 W	-	67 x 36 x 39 mm	Plastic
0610 K / D / 1	35 W	300 mm	308 x 37 x 55 mm	Plastic
0611 K / D / 1	60 W	500 mm	508 x 37 x 55 mm	Plastic
0656 K / D	120 W	1000 mm	1008 x 37 x 29 mm	Aluminium

## RaLEDina Serie

# Radium

- LED lamp for direct exchange with linear incandescent lamps

now dimmable



double based, opalised



single based, clear

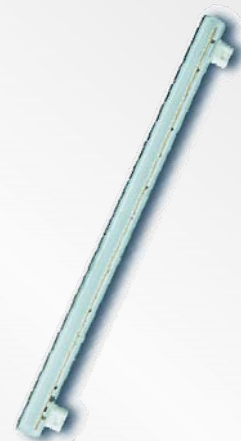

double based, clear

Art. No.	Watt	Lumious flux	Dimension	Base
425 14762 / opalised	6	250	30 x 300 mm	double / S14s
425 14763 / opalised	9	450	30 x 500 mm	double / S14s
425 14764 / opalised	6	250	30 x 300 mm	single / S14d
425 14765 / opalised	9	450	30 x 500 mm	single / S14d
425 14766 / clear	6	300	30 x 300 mm	double / S14s
425 14767 / clear	9	500	30 x 500 mm	double / S14s
425 14768 / clear	6	300	30 x 300 mm	single / S14d
425 14769 / clear	9	500	30 x 500 mm	single / S14d

## LED Torches

**brennstuhl®**



### LuxPremium Fokus-LED-Flashlight TL 100F IP 54

- very handy penlight with high luminosity
- with extremely bright 5W CREE-LED
- durable aluminium housing with clip
- dust protected and splash-proof, IP 54
- versatile and pocket-size



Art. No.	LEDs	Luminous Flux	Light duration
1 17860 0 051	5 W CREE	100 lm	5 h



### LuxPremium Rechargeable-Fokus-Selector-LED-Flashlight TL 350AFS IP 44

- combines high brightness and fast function selection
- with extremely bright 10 W CREE-LED
- durable aluminium housing with wrist strap
- mode selector for fast selection of the desired function
- several features: 100% - 70% - 40% - 10% - strobe - SOS
- infinitely focus from laminary light nearby to high beam focussed light
- with integrated Li-Ion-Battery 3.7 V / 2.0 Ah
- inclusive 100 - 240 V AC, 50/60 Hz charger and 12 - 24 V charger for cigarette lighter
- with 2 pin charger and SCHUKO / BS adapter

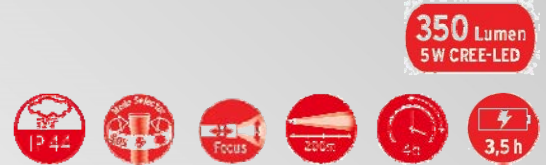

Art. No.	LEDs	Luminous Flux	Light duration
1 17860 3 200	10 W CREE	350 lm	4 h



### LuxPremium Rechargeable-Fokus-Selector-LED-Flashlight TL 500AFS IP 44

- extremely bright LED flashlight with high-quality focus function
- with extremely bright 10 W CREE-LED
- switch with soft-touch function for 100% - 30% - SOS
- infinitely focus from laminary light nearby to high beam focused light
- durable aluminium housing with wrist strap
- with integrated Li-Ion-Battery 3.7 V / 2.0 Ah with charging indicator
- including high-power adapter (100 - 240 V AC, 50/60 Hz) for short charging times and 12 - 24 V car charger
- with 2 pin charger and SCHUKO / BS adapter



Art. No.	LEDs	Luminous Flux	Light duration
1 17860 3 400	10 W CREE	500 lm	2 h



### LuxPrimera Focus LED Torch

- extreme bright LED Torch with new focus-technology
- continuous adjustable from a constant close light to a zooming distance light
- with new extra bright CREE POWER LED
- problem-free adjustable by one-hand operation
- 2 different settings and flashing function
- elegant, robust aluminium housing with wrist strap
- ON / OFF switch with soft-touch-function in „American Style“ at the end



Art. No.	LEDs	Luminous Flux	Light duration	Battery type
1 17874 0	1 x 1 W CREE	70 lm	3,5 h	1 x AA (incl.)
1 17875 0	1 x 5 W CREE	150 lm	3,5 h	3 x AAA (incl.)

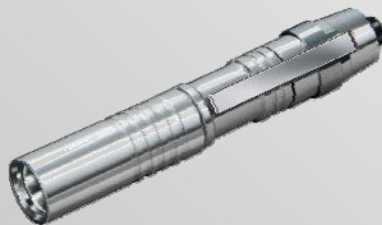

### LuxPrimera Pen-Light LED Torch

- handy flashlight for car, trade or hobby
- with bright 0,5 W LED
- versatile and pocket-size
- LED lifetime: 11 years of permanent use
- strong and sturdy aluminium body
- „American Style“ ON / OFF switch at the end of the torch



Art. No.	LEDs	Luminous Flux	Light duration
1 17597 0	1 x 0,5 W	15 lm	4 h



### Eco-Light FL DUO LED Torch

- LED lamp with laser pointer - the absolute trendy item
- 8 super-bright LEDs
- with integrated, powerful laser pointer class 2: P < 1 mW, l = 650 nm (DIN 60825-1:2008-05)
- handy metal housing
- soft touch switch with 2 functions: 1. LEDs on, 2. Laser pointer on



Art. No.	LEDs	Luminous Flux	Light duration
1 17989 0 100	8	45 lm	12 h



## LED Lamps

brennstuhl®

### LED Head-Light HL 10

*practical and adjustable headlight*



Art. No.	LED
1 17977 0	10 pieces

- focus angle can be adjusted
- with 10 ultra bright LEDs
- luminous flux appr. 30 lm
- pushbutton ON/OFF switch
- included 3 standard batteries AAA



### LuxPremium LED-Head Light

#### KL 100 IP 44

*Ultra light weight for comfort*

Art. No.	LED
1 17876 0	3 watt

- 3 watt extra bright LED for powerful light
- robust and ultra light housing
- 3 switching levels and SOS function
- adjustable focus angle
- 2 standard batteries AA included

### 7 + 1 LED Clip-On Lamp HL SB 71 MC

- 7 powerful LEDs with up to 6 hours of light ON time with full batteries
- additional setting provides another LED in the lamp head
- clip with integrated magnet turns 180°
- with ON / OFF switch
- 3 standard batteries AAA included
- in blister packing



Art. No.	LED	Luminous flux	Colour Temp.
1 17599 0	7 + 1	40 + 5 lm	7000 k



### 20 + 3 SMD LED-Universal Lamp HL DB 203 MH

- 20 super bright Seoul SMD LEDs with special lens optics
- operation time approx. 6 hours with full batteries
- additional switching stage for 3 x LEDs in the luminaire head with extra long light duration
- plastic handle with integrated magnet, 360° bendable
- 360° swivelled, retractable hanging hook
- with ON / OFF switch
- 3 standard batteries AAA included
- in blister packing



Art. No.	LED	Luminous flux	Colour Temp.
1 17542 0	20 + 3	105 + 18 lm	6000 k



### 2 + 3 LED Rechargeable Hand Lamp HL SA 23 MH

- 2 extra-bright LEDs with special optics
- Up to 2,5 hours of light ON time with fully charged battery
- additional switching stage for 3 x LEDs in the luminaire head with extra long light duration
- charging time about 2 hours
- 360° swivelled hook, adjustable up to +/- 90° with integrated magnet
- integrated Li-Ion battery 3.7 V / 650 mAh with charging indicator overload & deep discharge protection and USB charging interface
- with ON / OFF switch
- **Inclusive 100 - 240 V AC, 50/60 Hz and 12 V charger for car cigarette lighter**
- in blister packing



Art. No.	LEDs	Luminous flux	Colour Temp.	Plug
1175430	2 + 3	78 resp. 12	6500 k	Schuko
1175433	2 + 3	78 resp. 12	6500 k	BS



### 6 SMD LED Rechargeable Hand-Held Lamp HL DA 6 DM2H

- light, anytime, even without a charged battery
- option to charge the battery with integrated dynamo
- 6 super bright SMD LED's with up to 9 hours of light
- Energy-saving mode: Light power can be reduced to 30%
- Rubber-clad housing
- 360° adjustable hook and magnet
- Integrated Li-Ion battery with charging indicator
- **Inclusive 100 - 240 V AC, 50/60 Hz charger and 12 V charger for car cigarette lighter**
- in blister packing



Art. No.	LEDs	Luminous flux	Battery	Plug
1178590	6 SMD	210 / 65 lm	Li-Ion	Schuko
1178593	6 SMD	210 / 65 lm	Li-Ion	BS



## Solar Technology

brennstuhl®



180°

12 mtr



### Solar LED Light SOL 80 PLUS

with PIR sensor - IP 44

- solar lamp with motion detector and separat solar module
- pivoting solar lamp
- pivoting infrared motion detector with max. 180° detection angle and max range of 12mtr
- switch-on time adjustable to a max. of approx. 1 minute
- can operate independent of the mains
- response intensity adjustable by a twilight switch
- sensitivity adjustable
- 8 very bright LEDs for illumination of large areas
- inclusive of lead-gel battery
- with integrated over-charge and total discharge protection
- operating time of approx. 120 minutes with fully loaded rechargeable battery

Art. No.	LEDs	Luminous flux	Cable length	Colour
1 17085 0	8	appr. 350 lm	4,75 mtr.	white
1 17095 0	8	appr. 350 lm	4,75 mtr.	black



180°

10 mtr



### Solar LED-spot Duo Premium SOL SV/LV 1205 P2

with PIR sensor - IP 44

- solid and modern aluminium box
- solar panel can be mounted independent from the spot on the sunny side (incl. 4,75m cable)
- 12 powerfull LEDs
- both lights horizontal and vertical adjustable
- Infrared sensor with max. 180° angle of reach (horizontal) and max. of 10m of surrounding
- duty cycle adjustable between 10 sec. and 60 sec.
- response intensity adjustable by a twilight switch
- sensitivity adjustable
- 3 rechargeable and exchangeable NiMH Mignon AA batteries included (2200 mAh)
- light ON time is approx. 110 minutes with fully charged batteries
- solarmodul: 220 x 190 mm - Solar Power 2 Wp

Art. No.	UP	LEDs	Cable length	Colour	Diffuser
1 17943 0	1 piece	12 x 0,5 W	4,75 m	anthracite	clear
1 17944 0	1 piece	12 x 0,5 W	4,75 m	anthracite	frosted



180°

10 mtr



### Solar LED-spot Premium SOL SH/LH 1205 P2

with PIR sensor - IP 44

- solid and modern aluminium box
- solar panel can be mounted independent from the spot on the sunny side (incl. 4,75m cable)
- 12 powerfull LEDs
- both lights horizontal and vertical adjustable
- infrared sensor with max. 180° angle of reach (horizontal) and max. of 10m of surrounding
- duty cycle adjustable between 10 sec. and 60 sec.
- response intensity adjustable by a twilight switch
- sensitivity adjustable
- 3 rechargeable and exchangeable NiMH Mignon AA batteries included (2500 mAh)
- light ON time is approx. 90 minutes with fully charged batteries
- solarmodul: 220 x 190 mm - Solar Power 2 Wp

Art. No.	UP	LEDs	Cable length	Colour	Diffuser
1 17935 0	1 piece	12 x 0,5 W	4,75 m	anthracite	clear
1 17937 0	1 piece	12 x 0,5 W	4,75 m	anthracite	frosted

## Lighting Equipment

brennenstuhl®



### Safety Inspection lamp

- the inexpensive quality inspection lamp
- with impact resistant, flexible basket
- with protective glass cover
- supplied with Schuko or BS plug
- delivery without bulbs



Art. No.	Cable	Length	Output	Socket	Plug
1 17602 6	H05VV-F 2x0,75	5 mtr	60 watt	E 27	Schuko
1 17601 3	H05VV-F 2x0,75	5 mtr	60 watt	E 27	BS



### Rubber Hand Lamp

- the approved, robust inspection lamp
- wire basket with caps
- with protective glass cover
- handle made of high quality hard rubber for comfort when in constant use
- supplied with Schuko or BS plug
- delivery without bulbs

Art. No.	Cable	Length	Output	Socket	Plug
1 17646 0	H05RN-F 2x0,75	5 mtr	60 watt	E 27	Schuko
1 17676 6	H05VV-F 2x0,75	5 mtr	60 watt	E 27	Schuko
1 17651 0	H05RN-F 2x0,75	10 mtr	60 watt	E 27	Schuko
1 17678 3	H05VV-F 2x0,75	5 mtr	60 watt	E 27	BS



### Griplight

- gripper handle made from top quality plastic, adjustable opening
- special clamping jaws on an axial bearing with an adjustable clamp setting
- wire basket with caps
- with protective glass cover
- delivery without bulbs

Art. No.	Cable	Length	Output	Socket	Plug
1 17611 3	H05VV-F 2x0,75	5 mtr	60 watt	E 27	BS



## Lighting Equipment

brennenstuhl®



### LED Automotive & Workshop Inspection Lamp IP 54

- 54 bright SMD LEDs with extremely long lifespan
- impact and break-proof protective tube with glare protection
- robust, ergonomically formed handle with 6 ribs to stop rolling away
- dust protected and splash proof, IP 54
- sturdy, swivel hook
- built in non replaceable lamp

**optional:** with built-in li-ion battery 3.7 V/3 Ah, charging time abt. 3,5 hrs,

Art. No.	Cable	Length	LEDs	Colour Temp
1 17547 3	H05RN-F 2x1,0	5 mtr	54 SMD	6500 K
1 17548 3	-	-	54 SMD	6500 K



### Inspection Lamp

- robust and impact-resistant
- ergonomically designed handle
- with electronic ballast in the handle
- hexagonal handle, prevents rolling away
- with large rotating hanging hook
- supplied with Schuko or BS plug
- including lamp
- with or without ON/OFF switch

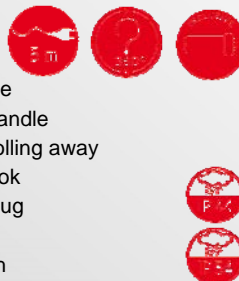

Art. No.	Cable	Length	Output	Socket	Plug
1 17711 0	H05RN-F 2x0,75	5 mtr	8 watt		Schuko
1 17723 0 with switch	H05VV-F 2x0,75	5 mtr	8 watt		Schuko
1 17710 3	H05VV-F 2x0,75	5 mtr	8 watt		BS
1 17728 3 with switch	H05RN-F 2x1,0	5 mtr	11 watt	G23	BS
1 17727 3 with switch	H07RN-F 2x1,0	5 mtr	18 watt	G24	BS

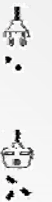

## ATEX Ex-Proof Rubber Hand Lamp IPX 5



- robust, handy inspection lamp with ergonomic handle
- hexagonal handle, prevents rolling away
- stable, galvanised wire basket for heavy use
- with protective glass resistant to sudden changes of temperatures glass no. 98 cover and anti-dazzle screen
- test conformity II2G EExed IIAT3
- delivery **without** cable and bulb

Art. No.	Output	Socket
439/GK	max. 60 watt	E 27

## LED Light

brennenstuhl®

### Chip LED Light L CN 150

for installation indoors and outdoors, IP 65 / IP 44  
High-power COB (Chip on board) LED for wall installation, with extra-wide light diffusion to illuminate a large area

- ideal for hobbyists, workshops and construction sites
- illuminates house entrances, garages, courtyards, halls etc.
- uses 80% less energy than conventional lamps
- bright light instantly
- low heat generation, no danger of injury
- chip LEDs have an extremely long lifespan, are shock-proof, maintenance-free
- die-cast aluminium casing
- with safety glass

Art. No.	Output	Luminous flux	Colour Temp.	
1 17125 0 101	10 W	700 lm	6400 K	
1 17125 0 102	10 W	700 lm	6400 K	with PIR sensor
1 17125 0 201	20 W	1300 lm	6400 K	
1 17125 0 202	20 W	1300 lm	6400 K	with PIR sensor
1 17125 0 301	30 W	2100 lm	6400 K	
1 17125 0 302	30 W	2100 lm	6400 K	with PIR sensor
1 17125 0 501	50 W	3500 lm	6400 K	
1 17125 0 502	50 W	3500 lm	6400 K	with PIR sensor



12 mtr

180°

#### optionally available with PIR sensor

- range of detection: up to 12 metres, angle 180°
- duty cycle adjustable between 10 sec. and 4 min.
- with twilight and sensitivity switch

## Solar Technology

brennenstuhl®

### Solar LED Wall Lamp SOL 04 Plus IP 44 with PIR Sensor

Practical and suitable for outdoor use, IP 44

- compact solar lamp with integrated solar module and PIR sensor
- 2 super-bright LEDs, good light for orientation
- detection angle approx. 100°, max. range 7 m
- light switches itself on automaticall for approx. 1 minute when detection area is breached
- with twilight sensor
- operating time of approx. 80-90 minutes with fully loaded rechargeable batteries
- 3 rechargeable and exchangeable NiMH Mignon AA batteries included

Art. No.	LEDs	Colour	Luminous flux	UP
1 17087 0	2 x 0,5 W	white	85 lm	1 piece
1 17097 0	2 x 0,5 W	black	85 lm	1 piece



### Solar LED Pavement Light SOL FL 13007 with PIR sensor and twilight sensor

Practical and suitable for outside use.

- Solar LED pavement light with 13 LEDs for good orientation light
- case made of weatherproof plastic and aluminium
- features one standby LED that is activated after dark; an additional 12 LEDs are switched on if motion is detected
- with integrated solar cell
- 3 rechargeable and exchangeable NiMH Mignon AA batteries included
- includes ground spike for placemant in the ground or mounting plate for easy installation on a firm ground, head easy removeable for seperate lighting source



Art. No.	UP	LEDs	Luminous flux	Colour
1 17079 0	1	13	91 lm	alu / silver



## Infrared Motion Detectors



### Infrared Motion Detector PIR 180/110 IP 44

automatically switches lamps on and off (incandescent, halogen and energy-saving bulbs) when someone enters the detection zone

- for indoor and outdoor use, IP 44
- detection angle 180° or 110°, range 12 mtr
- switch-on time adjustable from appx 10 seconds up to appx 4 min.
- response brightness adjustable
- switching capacity max. 1000 Watt (bulbs) or max. 300 Watt (energy-saving lamp)
- adjustable vertically and horizontally

Angle	Art. No. white colour	Art. No. anthracite colour	UP
110°	1 17089 0	1 17189 0	1 piece
180°	1 17090 0	1 17190 0	1 piece
240°	1 17091 0	1 17191 0	1 piece

## GRÄSSLIN

YOUR SENSES. OUR SOLUTIONS.



### Infrared Motion Detectors

automatically switches lamps on and off (incandescent, halogen and energy-saving bulbs) when someone enters the detection zone

- for indoor use, IP 40 (surface mounted) or IP 44 (flush-mounted)
- detection angle 360°
- switch-on time adjustable from appx. 5 seconds up to 30 min.
- response brightness adjustable from 10 to 2000 Lux
- max. switching capacity: incandescent halogen lamps (2000 W), LED + Energy Saving Lamps (400 W)

Art. No.	UP	Angle	Fitting	Detection range
18.06.0004.1	1 piece	360°	surface mounted	7m (2,5m height)
18.06.0005.1	1 piece	360°	flush mounted	8m (2,5m height)

## Call Boards Wall Mounted & Recessed



Wall Mounted Art. No.	Recessed Art. No.	Power	Call Number
No. 50.4/1R	No. 1304/1R	12 V	4
No. 50.6/1R	No. 1306/1R	12 V	6
No. 50.8/1R	No. 1308/1R	12 V	8
No. 50.10/1R	No. 1310/1R	12 V	10
No. 50.12/1R	No. 1312/1R	12 V	12
No. 50.16/1R	No. 1316/1R	12 V	16
No. 50.20/1R	No. 1320/1R	12 V	20
No. 50.24/1R	No. 1324/1R	12 V	24

Wall Mounted Art. No.	Recessed Art. No.	Power	Call Number
No. 50.4/3R	No. 1304/3R	230 V	4
No. 50.6/3R	No. 1306/3R	230 V	6
No. 50.8/3R	No. 1308/3R	230 V	8
No. 50.10/3R	No. 1310/3R	230 V	10
No. 50.12/3R	No. 1312/3R	230 V	12
No. 50.16/3R	No. 1316/3R	230 V	16
No. 50.20/3R	No. 1320/3R	230 V	20
No. 50.24/3R	No. 1324/3R	230 V	24

The falling tags call boards are used when the minimum consumption is required.

The call boards comes with a mechanical switch-off, horizontal surface, aluminium external application and buzzer, also available with 24 V.

## Transformers

Wall mount transformer with ABS anti-shock cover

Art. No.	Power	Voltage
1025	25 VA	4 - 8 - 12

Transformer for both DIN bar or wall mount, cover in self-

Art. No.	Power	Voltage
1130	30 VA	12 - 24



### Garden Spotlights with ground spike



- IP 55, E27, max. 100 W
- 2,50m rubber cable with schuko plug
- ANTI-UV and ANTI-CORROSION material
- caustic substance resistant
- adverse weather conditions resistant
- suitable for every climatic zone
- not fading color
- low cost of maintenance
- silicon gasket
- ceramic lampholder
- stainless steel screws
- individually packed in polybags
- delivery without bulbs

**Applications:** Garden, Promenade, Shopping Gallery e.g.

Art. No. (Schuko Plug)	Art. No. (BS-Plug)	Spotlights	Dimension
PAR 38 1/P	PAR 38 1/P/UK	1 piece	240 x 500 mm
PAR 38 2/P	PAR 38 1/P/UK	2 pieces	480 x 500 mm



### Wall Fixed Spotlights with installation base



- IP 55, E27, max. 100 W
- ANTI-UV and ANTI-CORROSION material
- caustic substance resistant
- adverse weather conditions resistant
- suitable for every climatic zone
- not fading color
- low cost of maintenance
- silicon gasket
- ceramic lampholder
- stainless steel screws
- individually packed in polybags
- delivery without bulbs

**Applications:** Garden, Balcony, Porch, Promenade, Shopping Gallery e.g.

Art. No.	Spotlights	Dimension
PAR 38 1/M	1 piece	240 x 230 mm
PAR 38 2/M	2 pieces	380 x 200 mm

### Double Socket Outlet with ground spike



- IP 55
- 2,50m rubber cable
- ANTI-UV and ANTI-CORROSION material
- caustic substance resistant
- adverse weather conditions resistant
- suitable for every climatic zone
- not fading color
- low cost of maintenance
- stainless steel screws

Art. No.	Dimension	Socket / Plug
PAR PRESA Schuko	110 x 380 mm	Schuko
PAR PRESA BS	110 x 380 mm	BS



## Bulkhead Fittings



57-1005-5702

For ceiling and wall mounting, plastic body and cage, crystal glass cover (inside prismatic structure), with 5 cable entries (one with a cable sleeve)

Available body colours:

Art. No. 57-1005-5702

- 5701 = black, - 5702 = grey, - 5703 = red, - 5705 = white, - 5706 = blue, - 5714 = silver-grey

Art. No.	Watt / V	IP	Socket	Size	Pieces / Carton	Protection Class
57-1005-5702	60 W / 250 V	IP 44	E 27	178 x 122 x 112 mm	4 pieces	II

with plastic cage



with metal clip system



57-1000-57V2

For ceiling and wall mounting, plastic body, protective steel wire cage, crystal glass cover (inside prismatic structure), 5 cable entries (one with a cable sleeve),

Available body colours:

Art. No. 57-1002-5702

- 5701 = black, - 5702 = grey, - 5705 = white

Art. No. 57-1000-57V2

- 57V1 = black, - 57V2 = grey, - 57V5 = white - 57V2 = grey

Art. No.	Watt / V	IP	Socket	Size	Pieces / Carton	Protection Class
57-1002-5702	60 W / 250 V	IP 44	E 27	176 x 122 x 110 mm	4 pieces	II
57-1000-57V2	60 W / 250 V	IP 44	E 27	171 x 122 x 110 mm	4 pieces	II

with metal cage



1020...

For ceiling and wall mounting, plastic body and cage, crystal glass cover (inside prismatic structure), with 3 cable entries (for 20 mm conduits)

Available body colours:

- 15 = white, - 19 = brown, - 16 = black, 18 = red, 12 = blue, 11 = grey, 13507 = silver

Art. No.	Watt / V	IP	Socket	Size	Pieces / Carton	Protection Class
10211 / 20011	60 W / 250 V	IP 44	E 27	170 x 125 x 110 mm	12 pieces	II

with plastic cage



- 3 and 4,5 W with SMD LED
- optical system: glass PRM diffuser
- plastic body with prismatic glass and metal cage
- available housing colour: white, silver, silver mat, blue, red. Brown and black
- mounting: surface
- three wire inputs
- including LED bulb
- RED or blue LED available on request

Art. No.	Watt / V	Colour Temperature	Lumious Flux	Size
2330...	3 W / 230 V	4000	210	120 x 170 x 105 mm
2332...	4,50 W / 230 V	3000	340	120 x 170 x 105 mm

LED with metal cage



- surface-mounted, oval shaped 4W LED luminaire, IP44
- 360 lumens light output, equipped with an opal diffuser made of Makrolon®LED (BAYER) with high light transmission of 93%.
- unique, patented design, includes direct installation of LED panels on the diffuser.
- the diffuser is connected to the base on a movable hinge, which provides easy access to the terminal block and mounting points of the lamp
- high colour rendering index Ra > 80
- highly impact-resistant fitting, IK10

Art. No.	Watt / V	Colour Temperature	Lumious Flux	Size
233432	4 W / 230 V	3000	320	90 x 160 x 50 mm
233425	4 W / 230 V	4000	360	90 x 160 x 50 mm

LED

## BAT-N Fittings



BAT-N T8



BAT-N T8

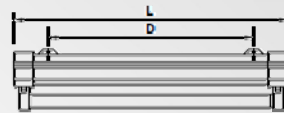
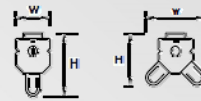

**Housing** in lacquered steel plate in white.

**Base** in galvanized steel plate where the electrical components are installed, easing the connection and its installation.

**Endcaps** in polycarbonate in white with UV protection.

### BAT-N T8

	Electronic	High Power Factor	Low Power Factor
1 x 18 W	10039383	10039382	10039381
1 x 36 W	10039388	10039387	10039386
1 x 58 W	10039393	10039392	10039391

### BAT-N T8

	Electronic	High Power Factor	Low Power Factor
2 x 18 W	10039398	10039397	10039396
2 x 36 W	10039403	10039402	10039401
2 x 58 W	10039408	10039407	10039406





PEP - transparent diffuser in polycarbonate (PC)

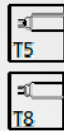

IP65



PEM - acrylic diffuser (SAN)

**Housing** in compressed glass fibre reinforced polyester in grey (RAL 7035). Polyurethane gasket to guarantee an IP65 rating.

**PEP** - transparent **diffuser** in polycarbonate (PC) - or **PEM** - acrylic **diffuser** (SAN) -, with UV protection, manufactured in injection with prismatic design for an optimum light distribution.

**Gear tray** manufactured in white lacquered steel plate.

Plastic **Clips**.

**Accessories**  
**Suspension Kit**  
Art. No. 414551

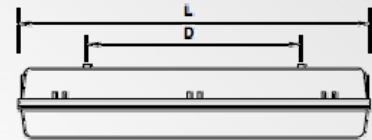
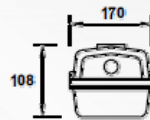
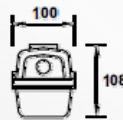

### PEP T5

	Electronic		Electronic
1 x 14 W	10017079	2 x 14 W	10016914
1 x 24 W	10094751	2 x 24 W	10094753
1 x 28 W	10017080	2 x 28 W	10016915
1 x 35 W	10017081	2 x 35 W	10022079
1 x 49 W	10016268	2 x 49 W	10016916
1 x 54 W	10016250	2 x 54 W	10016917
1 x 80 W	10094752	2 x 80 W	10094085

### PEM T5

	Electronic		Electronic
1 x 14 W	100944931	2 x 14 W	10015096
1 x 24 W	10094932	2 x 24 W	10015097
1 x 28 W	10094933	2 x 28 W	10015098
1 x 35 W	10051623	2 x 35 W	10015099
1 x 49 W	10020496	2 x 49 W	10015100
1 x 54 W	10094934	2 x 54 W	10015101
1 x 80 W	10015686	2 x 80 W	10015102

### PEP T8

	Electronic	High Power Factor	Low Power Factor
1 x 18 W	10012203	10012197	10012193
1 x 36 W	10012233	10007406	10012236
1 x 58 W	10012300	10012293	10012288
1 x 70 W	10094754	10094756	10094755
2 x 18 W	10012362	10012356	10007410
2 x 36 W	10007413	10012402	10012399
2 x 58 W	10014462	10012452	10012449
2 x 70 W	10094757	10094759	10094758

### PEM T8

	Electronic	High Power Factor	Low Power Factor
1 x 18 W	10012517	10007415	10012508
1 x 36 W	10012571	10012562	10012555
1 x 58 W	10012623	10012616	10012612
1 x 70 W	10094935	10094937	10094936
2 x 18 W	10012680	10012674	10007419
2 x 36 W	10012737	10012728	10012722
2 x 58 W	10012787	10012778	10012775
2 x 70 W	10094938	10094940	10094939

## LED Panels

**KISTENMACHER** LED panels are an economical and maintenance-free lighting solution for commercial spaces.

### LED Panel (Louver Type):

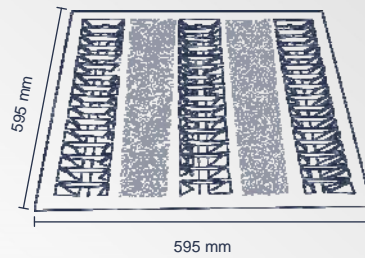
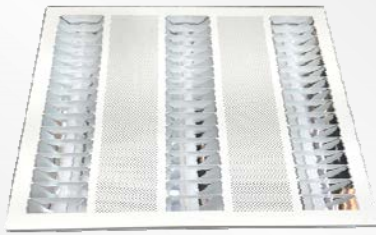

- Sturdy aluminum unibody housing and reflector
  - Classic T5-style design
- Available for recessed and surface mounting
  - Input: AC90-265V - 50/60 Hz.
  - Power Factor: >0,90

Art.-No.	Wattage	Luminous Flux	Colour Temp.	CRI
EGK LP2 595-36	36W	2.600 lm	3000- 6500K	Ra >75
EGK LP2 595-40	40W	3.600 lm	3000- 6500K	Ra >80

### LED Panel (Diffuser Type):

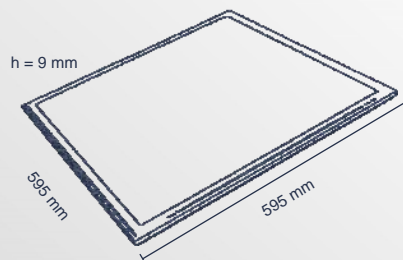
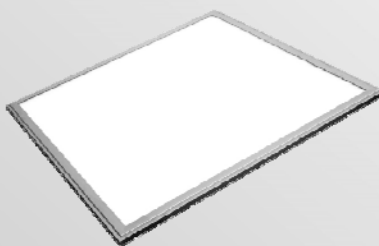

- Aluminum frame
- Slim side-lit design
- Size 595 x 595 x 9 mm
- Available for recessed, surface, suspension mounting
  - Input: AC90-265V - 50/60 Hz.
  - Surge protection
  - Power Factor: >0,88

Art.-No.	Wattage	Luminous Flux	Colour Temp.	CRI
EGK LP3 595-36	36W	2.700 lm	3000-6500K	Ra >70
EGK LP3-595-40	40W	3.200 lm	3000-6500K	Ra >80
EGK LP4-595-40	40W	3.500 lm	3000-6500K	Ra >80



## Halogen Flood Lights

**KISTENMACHER** halogen flood lights for domestic and industrial lighting purposes. In accordance with international standards our fittings have proven to be a reliable lighting solution for many years.

- aluminium die-cast body
- matt finishing (other finish on request)
- with plastic wiring box (nylon wiring box on request)
- available in black and white colour (other colours on request)



Art-No.	Wattage	Dimensions	Lampholder	Colour	Packing (pcs. / carton)
EGK-0500-B-PL	500W	183 x 145 x 120 mm	R7s	black	20 pcs.
EGK-1000-B-PL	1000W	273 x 202 x 136 mm	R7s	black	12 pcs.
EGK-1500-B-PL	1500W	345 x 226 x 168 mm	R7s	black	6 pcs.
EGK-0500-W-PL	500W	183 x 145 x 120 mm	R7s	white	20 pcs.
EGK-1000-W-PL	1000W	273 x 202 x 136 mm	R7s	white	12 pcs.
EGK-1500-W-PL	1500W	345 x 226 x 168 mm	R7s	white	6 pcs.



## LED Flood Lights

**KISTENMACHER** offers a completely new line of LED floodlights for direct replacement of conventional outdoor lighting solutions. The consistent use of high-grade components ensure a long lifetime of the lights.

### SMD Flat-Line Floodlight LF1:

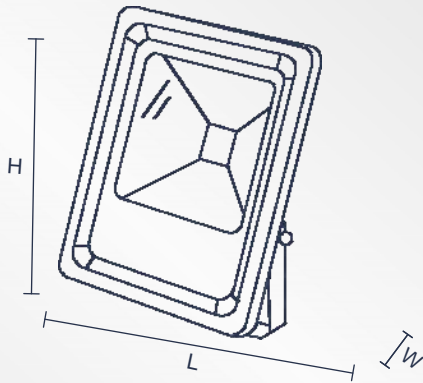

- Sturdy aluminum Housing
  - IP66 ingress protection
- Input: AC88-264V - 50/60 Hz.
  - Power Factor: >0,92
  - Lifetime: 25.000 hrs.+
  - Other light colours and RGB on request



#### Standard:

Art.-No.	Wattage	Luminous Flux	Colour Temp.	CRI	LED Config	Dimensions (mm)		
						L	H	W
EGK LF1-10-NW/DL	10W	800 lm	4000/6500K	Ra >80	20 x 2835	150	126	35
EGK LF1-20-NW/DL	20W	1600 lm	4000/6500K	Ra >80	63 x 5630	182	154	36
EGK LF1-30-NW/DL	30W	2400 lm	4000/6500K	Ra >80	96 x 5630	226	182	37
EGK LF1-50-NW/DL	50W	4000 lm	4000/6500K	Ra >80	150 x 5630	274	219	39
EGK LF1-80-NW/DL	80W	6400 lm	4000/6500K	Ra >80	240 x 5630	330	271	59
EGK LF1-100-NW/DL	100W	8000 lm	4000/6500K	Ra >80	294 x 5630	395	308	70
EGK LF1-200-NW/DL	200W	16000 lm	4000/6500K	Ra >80	588 x 5630	506	410	90

#### with integrated PIR sensor:

Art.-No.	Wattage	Luminous Flux	Colour Temp.	CRI	LED Config	Dimensions (mm)		
						L	H	W
EGK LF1-10-NW/DL-S	10W	800 lm	4000/6500K	Ra >80	20 x 2835	150	186	62
EGK LF1-20-NW/DL-S	20W	1600 lm	4000/6500K	Ra >80	63 x 5630	182	208	62
EGK LF1-30-NW/DL-S	30W	2400 lm	4000/6500K	Ra >80	96 x 5630	226	240	63
EGK LF1-50-NW/DL-S	50W	4000 lm	4000/6500K	Ra >80	150 x 5630	274	275	63

## LED Flood Lights

**KISTENMACHER** offers a completely new line of LED floodlights for direct replacement of conventional outdoor lighting solutions. The consistent use of high-grade components ensure a long lifetime of the lights.

### SMD Rugged-Line Floodlight LF2:

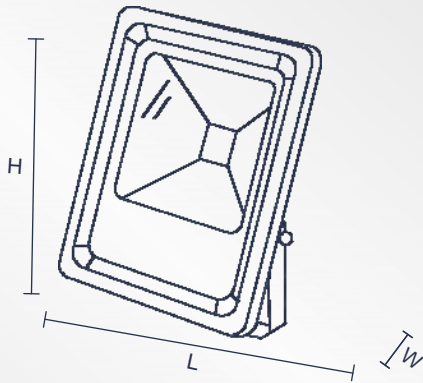

- Sturdy aluminum Housing
  - IP65 ingress protection
- Input: AC176-264V - 50/60 Hz.
  - Power Factor:
    - >0,92 (30-200W)
    - >0,60 (10-20W)
- Lifetime: 25.000 hrs.+
- Other light colours and RGB on request



#### Standard:

Art.-No.	Wattage	Luminous Flux	Colour Temp.	CRI	LED Config	Dimensions (mm)		
						L	H	W
EGK LF2-10-NW/DL	10W	650 lm	4000/6500K	Ra >80	5630	122	156	45
EGK LF2-20-NW/DL	20W	1300 lm	4000/6500K	Ra >80	5630	157	194	47
EGK LF2-30-NW/DL	30W	1950 lm	4000/6500K	Ra >80	5630	193	250	50
EGK LF2-50-NW/DL	50W	3250 lm	4000/6500K	Ra >80	5630	233	294	53
EGK LF2-80-NW/DL	80W	5200 lm	4000/6500K	Ra >80	5630	360	281	89
EGK LF2-100-NW/DL	100W	6500 lm	4000/6500K	Ra >80	5630	390	301	96
EGK LF2-200-NW/DL	200W	13000 lm	4000/6500K	Ra >80	5630	479	430	102

#### with integrated PIR sensor:

Art.-No.	Wattage	Luminous Flux	Colour Temp.	CRI	LED Config	Dimensions (mm)		
						L	H	W
EGK LF2-10-NW/DL	10W	650 lm	4000/6500K	Ra >80	5630	122	231	105
EGK LF2-20-NW/DL	20W	1300 lm	4000/6500K	Ra >80	5630	157	266	105
EGK LF2-30-NW/DL	30W	1950 lm	4000/6500K	Ra >80	5630	193	315	107
EGK LF2-50-NW/DL	50W	3250 lm	4000/6500K	Ra >80	5630	233	366	111

## LED Flood Lights

**KISTENMACHER** offers a completely new line of LED floodlights for direct replacement of conventional outdoor lighting solutions. The consistent use of high-grade components ensure a long lifetime of the lights.

### COB Rugged-Line Floodlight LF3:

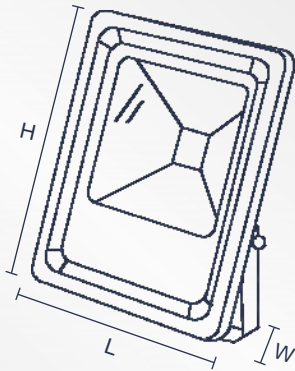

- Sturdy aluminum Housing
  - IP65 ingress protection
- Input: AC176-264V - 50/60 Hz.
  - Power Factor:
    - >0,92 (30-200W)
    - >0,60 (10-20W)
- Lifetime: 25.000 hrs.+
- Other light colours and RGB on request



#### Standard:

Art.-No.	Wattage	Luminous Flux	Colour Temp.	CRI	LED Config	Dimensions (mm)		
						L	H	W
EGK LF3-10-NW/DL	10W	650 lm	4000/6500K	Ra >80	1 x 10W	122	156	45
EGK LF3-20-NW/DL	20W	1300 lm	4000/6500K	Ra >80	1 x 20W	157	194	47
EGK LF3-30-NW/DL	30W	1950 lm	4000/6500K	Ra >80	1 x 30W	193	250	50
EGK LF3-50-NW/DL	50W	3250 lm	4000/6500K	Ra >80	1 x 50W	233	294	53
EGK LF3-80-NW/DL	80W	5200 lm	4000/6500K	Ra >80	2 x 40W	360	281	89
EGK LF3-100-NW/DL	100W	6500 lm	4000/6500K	Ra >80	2 x 50W	390	301	96
EGK LF3-200-NW/DL	200W	13000 lm	4000/6500K	Ra >80	4 x 50W	479	430	102

#### with integrated PIR sensor:

Art.-No.	Wattage	Luminous Flux	Colour Temp.	CRI	LED Config	Dimensions (mm)		
						L	H	W
EGK LF3-10-NW/DL-S	10W	650 lm	4000/6500K	Ra >80	1 x 10W	122	231	105
EGK LF3-20-NW/DL-S	20W	1300 lm	4000/6500K	Ra >80	1 x 20W	157	266	105
EGK LF3-30-NW/DL-S	30W	1950 lm	4000/6500K	Ra >80	1 x 30W	193	315	107
EGK LF3-50-NW/DL-S	50W	3250 lm	4000/6500K	Ra >80	1 x 50W	233	366	111

## LED Flood Lights

**KISTENMACHER** offers a completely new line of LED floodlights for direct replacement of conventional outdoor lighting solutions. The consistent use of high-grade components ensure a long lifetime of the lights.

### COB Classic-Line Floodlight LF4:

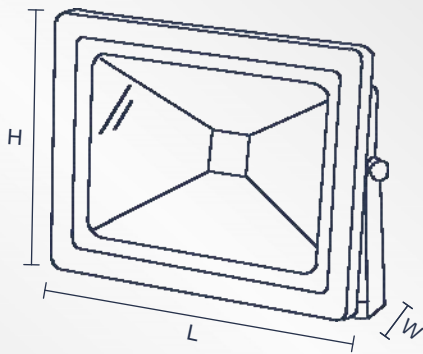

- Sturdy aluminum Housing
  - IP65 ingress protection
- Input: AC176-264V - 50/60 Hz.
  - Power Factor: >0,92
  - Lifetime: 25.000 hrs.+
  - Other light colours and RGB on request



#### Standard:

Art.-No.	Wattage	Luminous Flux	Colour Temp.	CRI	LED Config	Dimensions (mm)		
						L	H	W
EGK LF4-10-NW/DL	10W	650 lm	4000/6500K	Ra >80	1 x 10W	115	115	87
EGK LF4-20-NW/DL	20W	1300 lm	4000/6500K	Ra >80	1 x 20W	181	154	104
EGK LF4-30-NW/DL	30W	1950 lm	4000/6500K	Ra >80	1 x 30W	226	187	135
EGK LF4-50-NW/DL	50W	3250 lm	4000/6500K	Ra >80	1 x 50W	285	233	165
EGK LF4-100-NW/DL	100W	6500 lm	4000/6500K	Ra >80	2 x 50W	385	310	180
EGK LF4-150-NW/DL	150W	9750 lm	4000/6500K	Ra >80	3 x 50W	425	325	195
EGK LF4-200-NW/DL	200W	13000 lm	4000/6500K	Ra >80	4 x 50W	465	340	190

#### with integrated PIR sensor:

Art.-No.	Wattage	Luminous Flux	Colour Temp.	CRI	LED Config	Dimensions (mm)		
						L	H	W
EGK LF4-10-NW/DL	10W	650 lm	4000/6500K	Ra >80	1 x 10W	115		
EGK LF4-20-NW/DL	20W	1300 lm	4000/6500K	Ra >80	1 x 20W	181		
EGK LF4-30-NW/DL	30W	1950 lm	4000/6500K	Ra >80	1 x 30W	226		
EGK LF4-50-NW/DL	50W	3250 lm	4000/6500K	Ra >80	1 x 50W	285		

## LED High Bay Fixtures

**KISTENMACHER** offers a new line-up of heavy duty LED high bay fixtures, as a direct replacement of traditional lighting solutions for large industrial or commercial halls.

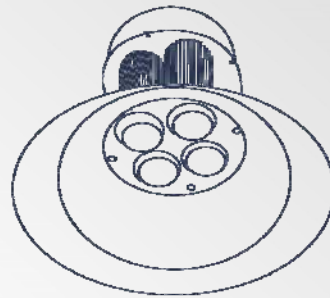

60° = 460 mm / 120° = 500 mm

- Sturdy aluminum Housing / Reflector
  - IP44 ingress protection
  - Multi column cooling design
- Available with 60° and 120° reflectors
  - Input: AC85-265V - 50/60 Hz.
    - Power Factor: >0,95
    - Lifetime: 25.000 hrs. +

Art.-No.	Wattage	Luminous Flux	Colour Temp.	CRI	LED Config
EGK LHB-PC01-50	50W	4.500 lm	3000 - 6500K	Ra >75	1 x 50W
EGK LHB-PC01-100	100W	9.000 lm	3000 - 6500K	Ra >75	1 x 100W
EGK LHB-PC01-150	150W	13.000 lm	3000 - 6500K	Ra >70	3 x 50W
EGK LHB-PC01-200	200W	18.000 lm	3000 - 6500K	Ra >70	4 x 50W

### LED High Bay COB (passive cooling - single column):

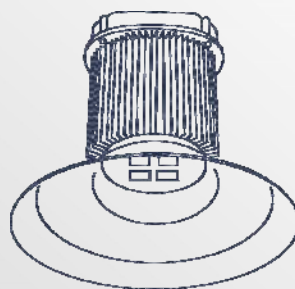

60° = 460 mm / 120° = 500 mm

- Sturdy aluminum Housing / Reflector
  - IP44 ingress protection
  - Single column cooling design
- Available with 60° and 120° reflectors
  - Input: AC85-265V - 50/60 Hz.
    - Power Factor: >0,90
    - Lifetime: 25.000 hrs. +

Art.-No.	Wattage	Luminous Flux	Colour Temp.	CRI	LED Config
EGK LHB-PC02-50	50W	3.500 lm	3000 - 6500K	Ra >70	1 x 50W
EGK LHB-PC02-100	100W	7.000 lm	3000 - 6500K	Ra >70	1 x 100W
EGK LHB-PC02-150	150W	10.500 lm	3000 - 6500K	Ra >70	3 x 50W
EGK LHB-PC02-200	200W	14.000 lm	3000 - 6500K	Ra >70	4 x 50W



## LED High Bay Fixtures

**KISTENMACHER** offers a new line-up of heavy duty LED high bay fixtures, as a direct replacement of traditional lighting solutions for large industrial or commercial halls.

### LED High Bay SMD (passive cooling - single column):

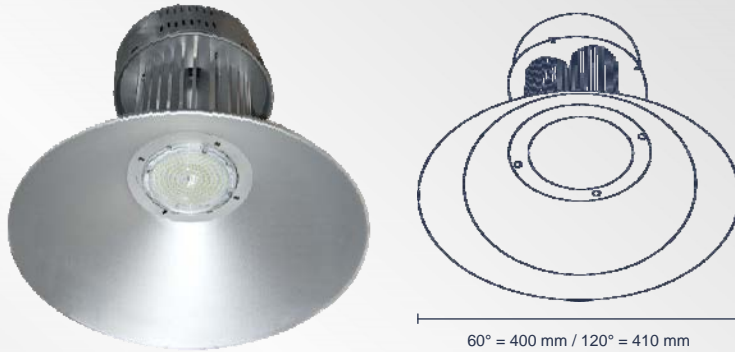

- Sturdy aluminum Housing / Reflector
  - IP44 ingress protection
- Single column active cooling design
- Available with 60° and 120° reflectors
  - Input: AC85-265V - 50/60 Hz.
    - Power Factor: >0,95
    - Lifetime: 25.000 hrs. +

Art.-No.	Wattage	Luminous Flux	Colour Temp.	CRI
EGK LHB-PS01-100	100W	9.500 lm	3000 - 6500K	Ra >70
EGK LHB-PS01-150	150W	14.000 lm	3000 - 6500K	Ra >70
EGK LHB-PS01-200	200W	19.000 lm	3000 - 6500K	Ra >70

### LED High Bay SMD (passive cooling - slim type):

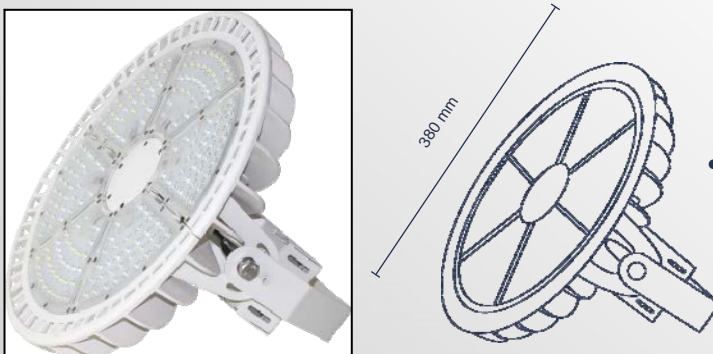

- Sturdy aluminum Housing / Reflector
  - Slim type passive cooling
- Available as 60°, 90° and 120° beam version
  - Input: AC90-305V - 50/60 Hz.
    - Power Factor: >0,90
    - Lifetime: 30.000 hrs. +

Art.-No.	Wattage	Luminous Flux	Colour Temp.	CRI
EGK LHB-PS02-100	100W	13.500 lm	3000 - 5700K	Ra >80
EGK LHB-PS02-150	150W	19.500 lm	3000 - 5700K	Ra >80
EGK LHB-PS02-200	200W	26.000 lm	3000—5700K	Ra >80

## Industrial Lightings

### COSMO 250 and 400 W

die-cast aluminium body, IP 65, IK 10



SM - wide and symmetric beam



CT - narrow beam 20° light



AS - with asymmetry vertex over 35°

### CONTINENTAL 1000 and 2000 W

die-cast aluminium body, IP 65, IK 10



SM - wide and symmetric beam



CT - narrow beam 20° light



AS - with asymmetry vertex over 35°

### STYLE 70 and 150 W

die-cast aluminium body, IP 66, IK 10



SM - wide and symmetric beam



AS - with asymmetry vertex at 30°



CTS - narrow beam 16° light



SMT - symmetric for ellipsoidal and tubular lamps

## Industrial Lightings



### AVANTGARDE

die-cast aluminium body, IP 65, IK 10



PRO - 70, 80, 100, 125, 150, 250 W



PLUS - 70, 80, 100, 125, 150, 250 W



XL - 150, 250, 400 W

### RUN 1000 and 2000 W

compact die-cast aluminium body  
IP 66, IK 10



### EASY 70, 125, 150, 250, 400 W

die-cast aluminium body  
IP 66, IK 10



EASY C



EASY S  
for elliptical shielded lamps

### EVOLUTION 250 and 400 W

die-cast aluminium body, IP 66, IK 10



SM - wide and symmetric beam



AS - with asymmetry vertex over 50°

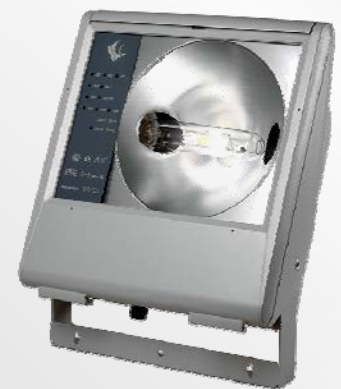

CT - narrow beam 20° light

## PMMA Plastic Globes



Transparent

### Standard Globes, PMMA - blow moulding

without base

colour: clear

Dia.	Neck Type	Available colours
150 mm	Screw	Smoked, Opal, Transparent, Gold
200 mm	Screw + bayonet	Smoked, Opal, Transparent, Gold
250 mm	Screw + bayonet	Smoked, Opal, Transparent
300 mm	Bayonet	Smoked, Opal, Transparent
400 mm	Bayonet	Smoked, Opal, Transparent
500 mm	Bayonet	Smoked, Opal, Transparent



Opal



Smoked

## Bases with E27 lampholder



NORMAL



NADIR (for wall/ceiling)



LAMAR (boundary wall)



TOVEL

Screw Neck	Bayonet Neck
150 + 200 mm	200, 250, 300, 400, 500 mm

Screw Neck
150 + 200 mm

Screw Neck	Bayonet Neck
150 + 200 mm	250 mm

Screw Neck	Bayonet Neck
150 + 200 mm	250 mm

## Glass Globe



### Glass Globe

without base

colour: opal

Art. No.	dia. / thread mm
GLOBE 150	150 / 84,5 mm



## Immersion Heaters

- nickel plated brass tube
- red level water indicator on assorted models
- red plastic handle with hanger clip
- white cable protection socket
- available in 220-250V or in 110-130V
- available with 2- and 3-core cable
- 100 or 200cm cable length available (except Art. No. 100 comes with 80 or 200cm length)

11 cm    12 cm    17 cm    17 cm    18,5 cm    22,5 cm    23 cm

600 Watt    1000 Watt    1000 Watt    1000 Watt    1500 Watt    2000 Watt    3000 Watt

3 core wire only

Art. No.	Watt	Art. No.	Watt	Art. No.	Watt	Art. No.	Watt	Art. No.	Watt	Art. No.	Watt	Art. No.	Watt
106	600	100	1000	1080	1000	1081	1000	112	1500	113	2000	114	3000

32 cm    21 cm    9 cm    9 cm

2000 Watt    2000 Watt    350 Watt    350 Watt

3 core wire only

Art. No.	Watt	Art. No.	Watt	Art. No.	Watt	Packing	Art. No.	Watt	Packing
320	2000	195	2000	158	350	Zipper Case	155	350	Alu-Cup + Zipper Case
				158 P	350	Polybag	165	350	Plastic-Cup + Zipper Case
							175	350	Glass-Cup + Zipper Case

## Quartz Heaters



Quartz Heater with metal front grill and white metal back with IP 24, protection class I, wall mounted, 4 step pull switch, with 1.2 meter length cable H05VV-F grey colour = 3x1.0 sqmm, with BSS plug, packed each in white colour single carton, 4 single cartons in one brown master carton

Art. No.	V	Hz	IP	Heating Steps	Size
HS 1200	220 - 230 V	50 - 60 Hz	IP 24	400W, 800W, 1200W	55 x 14 x 9 mm
HS 1800	220 - 230 V	50 - 60 Hz	IP 24	600W, 1200W, 1800W	55 x 14 x 9 mm



## Index

### A

Adaptor Plugs	26
Anchor + Screw Sets	28

### B

Bakelite Connectors	33
Ballasts	76,77
Battery Operated Tools	57
BAT-N Fittings	104
Bell Indicators	101
Bells	22
Bending Springs	40
Bottle Fuses	69
BS-Plugs	26
Bulkhead Fittings	103

### C

Cable & Insulating Tools	59
Cable Connectors	33
Cable Cutters	55
Cable Glands & Locknuts	36
Cable Junction Boxes	34,35
Cable Joint Kits	42,43
Cable Markers	39
Cable Reels	4,5,15,16
Cable Reels - CEE	4
Cable Roller	54
Cable Strippers	59
Cable Ties	37
Cables	54
Call Boards	101
Capacitors	78
Car Light Testers	65
CAT 6 Cable	53
CEE Connectors	46-50
CEE Plugs & Connectors	46-50
CEE Wall Mounted Plugs	48
CEE Wall Sockets	49
Ceramic Connectors	33
Chokes	76,77
Circuit Breakers	70
CO Detectors	14
Coaxial Cables	53
Connectors	33
Couplers	27
Crimping Hand Tools	56,57
Cutting Tools	55

### D

Detectors	14
Digital Weekly Timer	13
Distribution Boxes	34,35
Door Chimes	18-23
Door Openers	23
Door Stations	23
Draw-In Bands	41

### E

ELCB's	70
Electric Door Openers	23
Electrical Tapes	45
Electrician Tools	62
Electromagnetic Ballasts	74
Electronic Ballasts	76,77
Electronic Detectors	64,65
Electronic Mult Testers	64
Electronic Voltage Testers	64
Euro Connectors	33
Extension Sockets	6-11, 17
Explosion Proof-Handlamps	99

### F

Fire Blankets	13
Fish Tapes	41
Fit Pliers	63
Fixing Accessories	68
Float Switches	24,25
Fluorescent Tubes	92,92
Fuses	69
Fuses Accessories	69

### G

Garden Spotlights	100,102
Globes	116
GLS Lamps	91
Glue Guns	67
Griplights	99

### H

Halogen Flood Lights	107
Hand Lamps	99
Head Lights	97
Heat Detectors	14
Heat Shrinkable Tubes	44
Hole Saws	63
Hot Air Guns	66
Hydraulic Crimping & Cutting Tools	57,58
Hydraulic Punching Tools	60,61
Hydraulic Foot Pumps	58
Hydraulic Cable Cutters	58
Hydraulic Crimping Tool Sets	58

### I

Incandescent Lamps	91
Industrial Cable Reels	2-5
Ignitors	77
Immersion Heaters	117
Industrial Lightings	114,115
Industrial Socket Outlets	32
Inspection Lamps	99
Iron Plugs	26
Isolator Switches	28,71



## Index

<b>J</b>		<b>S</b>	
Joints	42,43	Safety Inspection Lamps	99
Junction Boxes	34,35	School Bells	22
<b>K</b>		Screwdrivers	62
KWH-Meters	73	Screw & Anchor Sets	68
<b>L</b>		Smoke Detectors	14
Lampholders	78	Socket Extensions	6-11,17
Lamps	81	Socket Outlets	32
LED Drivers	80	Solar LED Spots	98
LED Lamps	82-90	Spiral Wrapping Bands	38
LED Flood Lights	100,108-111	Splicing Kits	42,43
LED Head-Lights	97	Spot Lights	82-87
LED High Bays Fixtures	112	Steel Collars	68
LED Panels	106	Steel Draw in Bands	41
LED Spots	98	Strip-Lights	95
LED Torches	96	Surge Protections	11
LED Tubes	94	<b>T</b>	
Linear Lamps	95	Tapes	45
<b>M</b>		Terminal Connectors	33
Magnetic Ballasts	75	Testers	65
MCB's	70	Time Switches	72
Mechanical Cable Cutters	55	Torchlights	96,97
Mechanical Crimping Tools	55	Trailing Sockets	6-11,17
Motion Detectors	101	Transformers	75
<b>N</b>		Tubes	92,93
Neozed Fuses	69	TV Cables	53
<b>P</b>		<b>V</b>	
Pipe Bending Springs	40	VDE Pliers	63
Plastic Draw in Bands	41	VDE Screwdrivers	62
Plastic Globes	116	Voltage Testers	65
Pliers	63	Voltage Testers, Electronic	64
Plugs	26	Video Entry Kits	23
Porcelaine Connectors	33	<b>W</b>	
Pressure Switches	51	Walkie-Talkies	13
Pulling Springs	41	Wall Fixed Spotlights	102
Pump Switches	24,25	Water Heaters	117
Punching Technology	60,61	Weatherproof Lighting Fittings	105
PVC Connectors	33	Weatherproof Switches & Sockets	28-31
PVC Electrical Tapes	45	Weatherproof Isolating Switches	28
<b>Q</b>		Weekly Timers	13
Quartz Heaters	117	Wire Connectors	33
<b>R</b>		Wire Strippers	59
Ralina-Lamps	95	Wireless Door Bells	23
RCCB's	70		
Remote Control Sets	13		
Rubber Plugs & Couplers	27		
Rubber Hand Lamps	99		



## Notes