



**1** **Carpenters' Roofing Hammers DIN 7239**  
black, with tubular steel shaft and black grip (rough surface)

**BEST  
SELLER**



**2** **Carpenters' Roofing Hammers "BlackGiant"**  
black, with tubular steel shaft and 2-components grip orange/black (rough surface), additional pipe inside



**3** **Rivetting Hammers DIN 1041**  
german pattern ash wood handle



**4** **Rivetting Hammers DIN 1041**  
german pattern with handle protection and hickory handle



**5** **Rivetting Hammers DIN 1041**  
german pattern with fiberglass-handle and rubber grip



**6** **Sledge Hammers DIN 1042**  
cross peen - ash wood handle



**7** **Mining Sledges DIN 6476**  
double faced-ash wood handle



**8** **Engineers Hammers**  
with cross peen, english pattern, ash wood handle

**PICARD**

	Art.No.	Weight (g)	Handle Length (mm)
<b>1</b>	0040010	600	
<b>2</b>	0080010	600	
<b>3</b>	0000101-0050	50	
	0000101-0100	100	
	0000101-0150	150	
	0000101-0200	200	
	0000101-0250	250	
	0000101-0300	300	
	0000101-0400	400	
	0000101-0500	500	
	0000101-0600	600	
	0000101-0800	800	
	0000101-1000	1,000	
	0000101-1250	1,250	
	0000101-1500	1,500	
	0000101-2000	2,000	
<b>4</b>	0030312-0200	200	
	0030312-0300	300	
	0030312-0400	400	
	0030312-0500	500	
	0030312-0600	600	
	0030312-0800	800	
	0030312-1000	1,000	
	0030312-1500	1,500	
	0030312-2000	2,000	
<b>5</b>	0032100-0200	200	
	0032100-0300	300	
	0032100-0400	400	
	0032100-0500	500	
	0032100-0600	600	
	0032100-0800	800	
	0032100-1000	1,000	
	0032100-1500	1,500	
	0032100-2000	2,000	
<b>6</b>	0000201-03	3,000	600
	0000201-04	4,000	700
	0000201-05	5,000	800
	0000201-06	6,000	800
	0000201-08	8,000	900
	0000201-10	10,000	900
<b>7A</b>	0000401-1000	1,000	260
	0000401-1250	1,250	270
	0000401-1500	1,500	280
	0000401-2000	2,000	300
<b>7B</b>	0000401-03	3,000	600
	0000401-04	4,000	700
	0000401-05	5,000	800
	0000401-06	6,000	900
	0000401-08	8,000	900
	0000401-10	10,000	900
<b>8</b>	0001001-0100	1/4 lbs	
	0001001-0225	1/2 lbs	
	0001001-0340	3/4 lbs	
	0001001-0450	1 lbs	
	0001001-0500	1 1/8 lbs	
	0001001-0600	1 1/4 lbs	
	0001001-0700	1 1/2 lbs	
	0001001-0800	1 3/4 lbs	
	0001001-0900	2 lbs	

**1 Claw Hammers**

american pattern, with socket, black finish, ash wood handle



**3 Claw Hammers "Black Giant"**

american pattern, polished finish, with tubular steel shaft and 2-components grip orange/black (rough surface), additional pipe inside"



**2 Claw Hammers**

american pattern, polished finish, with tubular steel shaft and special grip



**4 Claw Hammers**

american pattern, polished finish, with fiberglass-handle and rubber grip



**5 Plastic Hammers**

with replaceable plastic heads - yellow colour ash wooden handle



**Spare-head**

red transparent CA  
Art.No. **110/...(handle size)**

yellow transparent CA  
Art.No. **111/...(handle size)**

**6 Nylon Hammers**

with replaceable nylon faces, loose faces in all sizes



**Spare-head**

white nylon plastic  
Art.No. **112/...(handle size)**

**7 Copper Hammers**

Sledge Hammer shape with ash wood handle



**8 Wooden Mallets**

head white beech wood material with metal coat, handle and wedge glued, ash wood handle



**9 Wooden Mallets without metal coat**

head white beech wood material. Handle and wedge glued, ash wood handle



**10 Rubber Mallets**

with flat faces with ash wood handle



Art.No.	Weight	Suitable for (g)	Head Size (mm)	Handle Size (mm)
<b>1</b> 0009231-25	16 oz			
0009231-27	20 oz			
<b>2</b> 0029100-13	13 oz			
0029100-16	16 oz			
0029200-20	20 oz			
<b>3</b> 0089100-16	16 oz			
0089100-20	20 oz			
<b>4</b> 0029400-16	16 oz			
<b>5</b> 0033001-0250	250 g			
0033001-0500	500 g			
0033001-0750	750 g			
0033001-1000	1,000 g			
0033001-1500	1,500 g			
0033001-2000	2,000 g			
<b>6</b> 101/22		140		22
101/27		215		27
101/32		310		32
101/35		395		35
101/40		530		40
101/50		828		50
101/60		1,350		60
<b>7</b> 102/22		139		22
102/27		207		27
102/32		304		32
102/35		370		35
102/40		509		40
102/50		804		50
102/60		1,278		60
<b>8</b> 0032001-1			50 x 100	
0032001-2			60 x 120	
0032001-3			70 x 140	
0032001-4			80 x 160	
<b>9</b> 602			40 x 80	
603			50 x 100	
604			60 x 120	
605			70 x 140	
606			80 x 160	
607			90 x 180	
<b>10</b> 571.1	160 g		80 x 40	
571.2	340 g		90 x 54	
571.3	550 g		110 x 65	
571.4	750 g		127 x 75	
571.5	1250 g		140 x 90	

**1 Hammer Handles** made of ash wood

**2 Mining Sledge Hammer Handles** made of ash wood

**3 Sledge Hammer Handles** made of ash wood

**4 Pickaxe Handles** made of of beech wood

**4A oval shape**
**4B round shape**

**5 Shovel Handles**

made of beech wood

**6 File Handles**

made of beech wood

**7 Metal Wedges**

**8 Pinching Bars**

with strong shaft



Art.No.	Suitable for (g)	Handle Length (mm)	Handle Dia (mm)	
<b>1</b> 111.26	100	260	17 x 10	
111.28	200	280	19 x 11	
111.30	300	300	21 x 12	
111.32	500	320	26 x 15	
111.35	800	350	29 x 17	
111.36	1,000	360	31 x 18	
111.38	1,500	380	33 x 20	
111.40	2,000	400	37 x 22	
111.45	...	450	42 x 24	
111.50	...	500	42 x 24	
<b>2</b> 115.28	1,000	280	33 x 20	
115.30	1,500	300	37 x 22	
115.35	2,000	350	37 x 22	
<b>3</b> 111.60	3,000	600	42 x 24	
111.80	5,000	800	48 x 28	
111.90	12,000	900	59 x 35	
<b>4A</b> 44PN		95	44 x 76	
<b>4B</b> 55PR		95	55	
60PR		95	60	
<b>5</b> 130SH		130	41	
<b>6</b> 201.80		80	18	
201.90		90	20	
201.100		100	22	
201.110		110	25	
201.120		120	28	
201.130		130	30	
201.140		140	32	
201.150		150	34	
201.160		160	36	
Art.No.	Size	Handle Length (mm)	Head Size (mm)	Shaft Dia (mm)
<b>7</b> 327.00	00		13	
327.0	0		16	
327.1	1		20	
327.2	2		23	
327.3	3		26	
327.4	4		29	
327.5	5		33	
327.55	5.5		40	
327.6	6		50	
<b>8</b> 0004640-050		500		19
0004640-060		600		20
0004640-070		700		21
0004640-080		800		22
0004640-100		1000		25

**1 Hatchets (German Type)**

in accordance to German DIN standards, safety proofed, with ash wooden handle, red-dipped grip



**2 Axes (German Type)**

in accordance to German DIN standards, safety proofed, with ash wooden handle, red-dipped grip



**3 Hatchets (American Type)**

yankee version with ash wooden handle, red dipped grip



**4 Axes (American Type)**

yankee version with ash wooden handle, red dipped grip

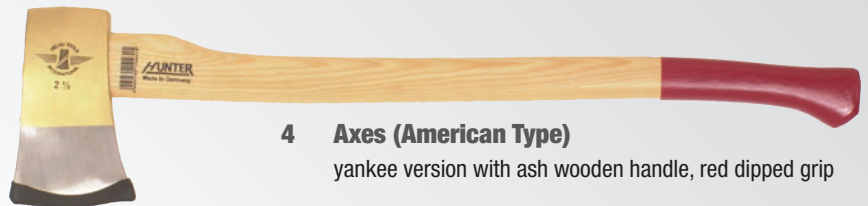

	Art.No.	Weight		Handle Length (mm)	
		(g)	(lb)		
<b>1</b>	11306	600		360	
	11307	700		360	
	11308	800		380	
	11310	1000		400	
<b>2</b>	10110	1000		600	
	10112	1250		700	
	10114	1400		700	
	10116	1600		800	
	10117	1750		900	
	10120	2000		900	
	10122	2250		900	
	<b>3</b>	11246	600	1 1/4	380
		11427	700	1 1/2	380
		11428	800	1 3/4	380
11429		900	2	380	
<b>4</b>		10471	1250	2 1/2	600
	10473	1350	3	700	
	10476	1600	3 1/2	700	
	10478	1800	4	800	
	10480	2000	4 1/2	900	
	10482	2250	5	900	
	10487	2700	6	900	
	<b>5</b>	121121-X5	480		228
<b>6</b>		121420-X7	640		355
	121440-X10	980		440	
	121460-X15	1520		599	
<b>7</b>	122440-X11	1075		443	
	122460-X17	1570		722	
	122480-X25	2430		722	
	122500-X27	2600		915	
<b>8</b>	120740	90		165	

**5 Camping Axes**

ideal for camping and other outdoor activities, made of ultra light and durable FiberComp handle, blade made of carbon steel PTFE coating



**6 Chopping Axes**

specially designed for carpenters and construction workers  
 - 30 degree cutting bevel angle for chopping axes  
 - ultra light and durable FiberComp™ handle  
 - blade made of carbon steel PTFE coating



**7 Splitting Axes**

for splitting large logs  
 - 35 degree convex cutting bevel angle for splitting axes  
 - the convex shape strengthens the edge to make it less sensitive to fracture  
 - ultra light and durable FiberComp™ handle  
 - blade made of carbon steel PTFE coating

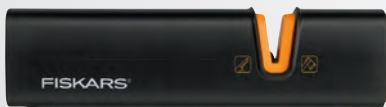
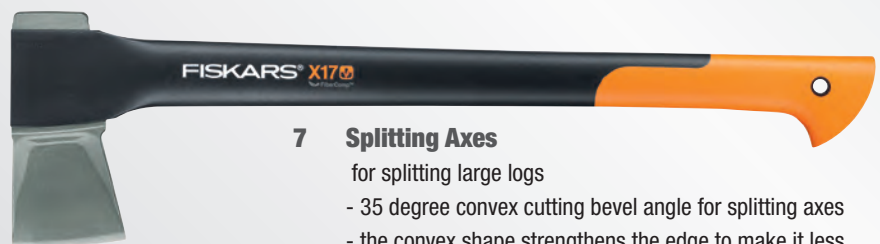

**8 Axe and Knife Sharpeners**

for regular maintenance for Fiskars axes/knives, optimized sharpening angle for blades with easy-to-use mechanism

**1 Pointed Chisels**

octagonal special tool steel - oven finish, available finish:

**1A blue shaft, silver lacquered point**

**1B black shaft, red lacquered point**

**2 Flat Chisels**

octagonal special tool steel - oven finish, available finish:

**2A blue shaft, silver lacquered point**

**2B black shaft, red lacquered point**

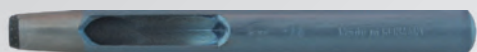
**3 Belt Punches**

plain, blue lacquered oven finish, with fine polished nose

**4 Arch Punches**

drop forged quality, blue lacquered oven finish, channel polished

**5 Belt Punch Sets** packing in plastic bags

plain, blue lacquered oven finish, with fine polished nose

**9 pcs set** consisting of 2-3-4-5-6-7-8-9-10 mm

**12 pcs set** consisting of 2-3-4-5-6-8-10-11-13-14-16-19 mm

**12 pcs set** consisting of 2-3-4-5-6-7-8-9-10-11-12-13 mm

Art.No. **001.109**

Art.No. **001.100**

Art.No. **001.113**

**6 Arch Punch Sets** packing in plastic bags

drop forged quality, blue lacquered oven finish, channel polished

**6 pcs set** consisting of 2-4-6-8-10-12 mm

**6 pcs set** consisting of 3-6-8-10-16-20 mm

**8 pcs set** consisting of 3-6-8-10-12-16-20-25 mm

**10 pcs set** consisting of 2-4-6-8-10-12-14-16-18-20 mm

**10 pcs set** consisting of 3-5-7-8-10-13-16-19-22-25 mm

Art.No. **003.2SP06**

Art.No. **003.2SP04**

Art.No. **003.2SP03**

Art.No. **003.2SP01**

Art.No. **003.2SP10**

Length (inch)	Size (mm)	Cutting Edge (mm)	<b>1 A/B</b> Art.No.	∅ (mm)	<b>3</b> Art.No.	<b>4</b> Art.No.								
6"	150 x 10		76853 15010	1.0	001.001		22.0	003.222	47.0	003.247	72.0	003.172	97.0	003.197
6"	150 x 12		76853 15012	1.5	001.026		23.0	003.223	48.0	003.248	73.0	003.173	98.0	003.198
7"	175 x 12		76853 17512	2.0	001.002	003.202	24.0	003.224	49.0	003.249	74.0	003.174	99.0	003.199
8"	200 x 18		76853 20018	2.5	001.027		25.0	003.225	50.0	003.250	75.0	003.175	100.0	003.000
10"	250 x 18		76853 25018	3.0	001.003	003.203	26.0	003.226	51.0	003.151	76.0	003.176	101.0	003.001
12"	300 x 18		76853 30018	3.5	001.028		27.0	003.227	52.0	003.152	77.0	003.177	102.0	003.002
14"	350 x 18		76853 35018	4.0	001.004	003.204	28.0	003.228	53.0	003.153	78.0	003.178	103.0	003.003
16"	400 x 18		76853 40018	4.5	001.029		29.0	003.229	54.0	003.154	79.0	003.179	104.0	003.004
				5.0	001.005	003.205	30.0	003.230	55.0	003.155	80.0	003.180	105.0	003.005
			<b>2 A/B</b>	6.0	001.006	003.206	31.0	003.231	56.0	003.156	81.0	003.181	106.0	003.006
5"	125 x 10	13	76852 12510	7.0	001.007	003.207	32.0	003.232	57.0	003.157	82.0	003.182	107.0	003.007
5"	125 x 12	15	76852 12512	8.0	001.008	003.208	33.0	003.233	58.0	003.158	83.0	003.183	108.0	003.008
6"	150 x 10	13	76852 15010	9.0	001.009	003.209	34.0	003.234	59.0	003.159	84.0	003.184	109.0	003.009
6"	150 x 12	15	76852 15012	10.0	001.010	003.210	35.0	003.235	60.0	003.160	85.0	003.185	110.0	003.010
7"	175 x 12	15	76852 17512	11.0	001.011	003.211	36.0	003.236	61.0	003.161	86.0	003.186	111.0	003.011
8"	200 x 16	22	76852 20016	12.0	001.012	003.212	37.0	003.237	62.0	003.162	87.0	003.187	112.0	003.012
8"	200 x 18	25	76852 20018	13.0	001.013	003.213	38.0	003.238	63.0	003.163	88.0	003.188	113.0	003.013
10"	250 x 16	22	76852 25016	14.0	001.014	003.214	39.0	003.239	64.0	003.164	89.0	003.189	114.0	003.014
10"	250 x 18	25	76852 25018	15.0	001.015	003.215	40.0	003.240	65.0	003.165	90.0	003.190	115.0	003.015
12"	300 x 18	25	76852 30018	16.0	001.016	003.216	41.0	003.241	66.0	003.166	91.0	003.191	116.0	003.016
14"	350 x 18	25	76852 35018	17.0	001.017	003.217	42.0	003.242	67.0	003.167	92.0	003.192	117.0	003.017
16"	400 x 18	25	76852 40018	18.0	001.018	003.218	43.0	003.243	68.0	003.168	93.0	003.193	118.0	003.018
				19.0	001.019	003.219	44.0	003.244	69.0	003.169	94.0	003.194	119.0	003.019
				20.0	001.020	003.220	45.0	003.245	70.0	003.170	95.0	003.195	120.0	003.020
				21.0		003.221	46.0	003.246	71.0	003.171	96.0	003.196		

- 1 Punch Gasket Cutter Sets** packing in metal boxes with threaded tubes (3-10 mm) and smooth tubes
  - 10 pcs set** Art.No. **8004.20**  
consisting of 3-4-6-8-10-12-14-16-18-20 mm
  - 15 pcs set** Art.No. **8004.30**  
consisting of 3-4-6-8-10-12-14-16-18-20-22-24-26-28-30 mm
  - 20 pcs set** Art.No. **8004.40**  
consisting of 3-4-6-8-10-12-14-16-18-20-22-24-26-28-30-32-34-36-38-40 mm
  - 25 pcs set** Art.No. **8004.50**  
consisting of 3-4-6-8-10-12-14-16-18-20-22-24-26-28-30-32-34-36-38-40-42-44-46-48-50 mm



- 4 Centre Punches**  
chrome vanadium steel, octagonal shank, lacquered oven finish
- 5 Centre Punches**  
plain, polished point, lacquered oven finish
- 6 Centre Punches**  
special tool steel, octagonal shank, lacquered oven finish
- 7 Brad Punches**  
chrome vanadium steel, octagonal shank, lacquered oven finish
- 8 Brad Punches**  
plain, polished point, lacquered oven finish
- 9 Brad Punches**  
special tool steel, octagonal shank, lacquered oven finish
- 10 Parallel Pin Punches**  
chrome vanadium steel, octagonal shank lacquered oven finish  
**10A with non spread head / 10B with unground shaft**



Size (mm)	<b>4</b> Art.No.	Size (mm)	<b>7</b> Art.No.	Size (mm)	<b>8</b> Art.No.	<b>9</b> Art.No.	Size (mm)	<b>10A</b> Art.No.	<b>10B</b> Art.No.
<b>100 x 10</b>	007.001	<b>100 x 10 x 2</b>	007.102	<b>100 x 8 x 1</b>	006.181		<b>150 x 10 x 1.5</b>	014.015	
<b>120 x 10</b>	007.002	<b>120 x 10 x 1</b>	007.111	<b>100 x 8 x 2</b>	006.182		<b>150 x 10 x 2.0</b>	014.002	016.002
<b>120 x 12</b>	007.003	<b>120 x 10 x 2</b>	007.112	<b>100 x 8 x 3</b>	006.183		<b>150 x 10 x 2.5</b>	014.025	
<b>150 x 12</b>	007.004	<b>120 x 10 x 3</b>	007.113	<b>100 x 8 x 4</b>	006.184		<b>150 x 10 x 3.0</b>	014.003	016.003
<b>150 x 14</b>	007.005	<b>120 x 10 x 4</b>	007.114	<b>100 x 10 x 1</b>	006.101		<b>150 x 10 x 3.5</b>	014.035	
<b>180 x 18</b>	007.006	<b>120 x 10 x 5</b>	007.115	<b>100 x 10 x 2</b>	006.102		<b>150 x 10 x 4.0</b>	014.004	016.004
		<b>120 x 10 x 6</b>	007.116	<b>100 x 10 x 3</b>	006.103		<b>150 x 10 x 5.0</b>	014.005	016.005
	<b>5</b>	<b>120 x 12 x 1</b>	007.121	<b>100 x 10 x 4</b>	006.104		<b>150 x 10 x 6.0</b>	014.006	016.006
<b>100 x 8</b>	006.008	<b>120 x 12 x 2</b>	007.122	<b>120 x 10 x 1</b>	006.111	008.111	<b>150 x 10 x 7.0</b>	014.007	016.007
<b>100 x 10</b>	006.001	<b>120 x 12 x 3</b>	007.123	<b>120 x 10 x 2</b>	006.112	008.112	<b>150 x 10 x 8.0</b>	014.008	016.008
<b>120 x 10</b>	006.002	<b>120 x 12 x 4</b>	007.124	<b>120 x 10 x 3</b>	006.113	008.113	<b>150 x 12 x 6.0</b>	014.016	
<b>120 x 12</b>	006.003	<b>120 x 12 x 5</b>	007.125	<b>120 x 10 x 4</b>	006.114	008.114	<b>150 x 12 x 7.0</b>	014.017	
<b>150 x 12</b>	006.004	<b>120 x 12 x 6</b>	007.126	<b>120 x 10 x 5</b>	006.115	008.115	<b>150 x 12 x 8.0</b>	014.018	
		<b>120 x 12 x 7</b>	007.127	<b>120 x 10 x 6</b>	006.116	008.116	<b>150 x 12 x 9.0</b>	014.019	
	<b>6</b>	<b>120 x 12 x 8</b>	007.128				<b>150 x 12 x 10.0</b>	014.020	
<b>100 x 10</b>	008.001	<b>120 x 12 x 10</b>	007.120				<b>150 x 14 x 10.0</b>	014.030	
<b>120 x 10</b>	008.002	<b>150 x 12 x 4</b>	007.134				<b>150 x 14 x 12.0</b>	014.040	
<b>120 x 12</b>	008.003	<b>150 x 12 x 8</b>	007.138						
<b>150 x 12</b>	008.004	<b>150 x 12 x 9</b>	007.139						
		<b>150 x 12 x 10</b>	007.130						
		<b>150 x 14 x 8</b>	007.148						
		<b>150 x 14 x 10</b>	007.140						
		<b>150 x 14 x 12</b>	007.142						
		<b>175 x 16 x 11</b>	007.151						
		<b>175 x 16 x 12</b>	007.152						

**1 Brad and Centre Punch Sets**

chrome vanadium steel, octagonal shank  
lacquered oven finish  
packing with plastic case  
6 pcs set consisting of brad punches  
10 x 120 x 2, 3, 4, 5 mm; 12 x 120 x 6 mm  
centre punch 12 x 120 mm

Art.No. **007.400****2 Brad and Centre Punch Sets**

plain, polished point, lacquered oven finish  
6 pcs set consisting of brad punches  
10 x 120 x 2, 3, 4, 5, 6 mm  
centre punch 10 x 120 mm

Art.No. **006.400****3 Brad and Centre Punch Sets**

special tool steel, octagonal shank  
lacquered oven finish  
packing with plastic case  
6 pcs set consisting of brad punches  
10 x 120 x 2, 3, 4, 5, 6 mm  
centre punch 10 x 120 mm

Art.No. **008.400****4 Tool Sets**

chrome vanadium steel,  
octagonal shank,  
lacquered oven finish,  
packing with plastic case  
6 pcs set consisting of  
flat chisel 12 x 150 mm,  
10 x 125 mm  
cross chisel 10 x 125 mm  
brad punch 12 x 150 x 4 mm;  
10 x 120 x 2 mm  
centre punch 10 x 120 mm

Art.No. **009.400****5 Tool Sets**

special tool steel,  
octagonal shank  
lacquered oven finish  
packing with plastic case  
6 pcs set consisting of  
flat chisel 12 x 150 mm;  
10 x 125 mm  
brad punch 10 x 120 x 2, 3, 4 mm  
centre punch 12 x 150 mm

Art.No. **010.400****6 Parallel Pin Punch Sets**

6pcs set, consisting  
of 3, 4, 5, 6, 7, 8 mm,  
with non spread head,  
chrome vanadium steel,  
octagonal shank  
lacquered oven finish  
packing with plastic case

Art.No. **014.400****7 Parallel Pin Punch Sets**

6pcs set, consisting of  
3, 4, 5, 6, 7, 8 mm,  
chrome vanadium steel,  
octagonal shank lacquered  
oven finish,  
packing with plastic bag

**7A**Art.No. **014.200**  
with non spread head**7B**Art.No. **016.200**  
with unground shaft



**1 Circular Gasket Cutters**  
bright polished prismatic rule with millimeter scale  
adjustable cutting blades with plastic handle



**2 Circular Gasket Cutters**  
bright polished prismatic rule  
with millimeter scale adjustable  
cutting blades with wooden handle

Cutting Dia (mm)	1	2
	Art.No.	Art.No.
200	321-200	
300		8014030001
400	321-400	8014040001
500		8014050001
600	321-600	8014060001
800	321-800	8014080001
1000		8014100001

Size	4	5
	2.0	328-102KIC
3.0	328-103KIC	329-203KIC
4.0	328-104KIC	329-204KIC
5.0	328-105KIC	329-205KIC
6.0	328-106KIC	329-206KIC
8.0	328-108KIC	329-208KIC
10.0	328-110KIC	329-210KIC
12.0	328-112KIC	329-212KIC
15.0	328-115KIC	329-215KIC
20.0	328-120KIC	329-210KIC

Size	6	7
	10	2010
15	2015	3015
20	2020	3020
25	2025	3025
30	2030	3030
35	2035	3035
40	2040	3040
50	2050	3050
60	2060	3060
70	2070	3070
80	2080	3080
90	2090	3090
100	2100	3100
120	2120	3120
150	2150	3150
180	2180	3180
200	2200	3200
250	2250	3250
300	2300	3300



**3 Signograph 25 Sets**  
a powerful engraver with interchangeable hardened stylus and hard metal stylus  
- especially suitable for hard materials and for all soft metals, plastic, etc.

Art.No. **1500743** with 2mtr. cable and BS plug  
Art.No. **1500740** with 2mtr. cable and Schuko plug

**4 Sets of Number Punches 0-9**  
9 pcs set in blue plastic box



**5 Sets of Figure Punches A-Z**  
27 pcs set in blue plastic box



**6 Sets of Number Stencils 0-9**



**7 Sets of Figure Stencils A-Z**

















**Screwdrivers Comfort Line**

blade chrome plated, with black tip, multicomponent handle, blue/black

- |  |   |
|--|---|
| <b>1 Assortments, 6 parts</b> Art.No. <b>65602</b><br>3 x  5.0 x 100; 6.0 x 125; 7.0 x 150<br>2 x  PH 1; PH 2 (optional PZ)<br>1 x  4.0 x 100 | <b>2 Assortments, 6 parts</b> Art.No. <b>65612</b><br>3 x  4.5 x 90; 5.5 x 100; 7.0 x 125<br>2 x  PH 1; PH 2 (optional PZ)<br>1 x  4.0 x 100 |
| <b>3 TORX Assortments, 7 parts</b> Art.No. <b>65617</b><br>7 x  T10; T15; T20; T25; T27; T30; T40   | <b>4 TORX-TR Assortments, 6 parts</b> Art.No. <b>65616</b><br>6 x  T10; T15; T20; T25; T27; T30  |



**Screwdrivers Basic Line**

blade chrome plated, with black tip, basic plastic handle, black

- |  |   |
|--|---|
| <b>5 Assortments, 6 parts</b> Art.No. <b>56060</b><br>3 x  5.0 x 100; 6.0 x 125; 7.0 x 150<br>2 x  PH 1; PH 2 (optional PZ)<br>1 x  4.0 x 100 | <b>6 Assortments, 6 parts</b> Art.No. <b>56070</b><br>3 x  4.5 x 90; 5.5 x 100; 7.0 x 125<br>2 x  PH 1; PH 2 (optional PZ)<br>1 x  4.0 x 100 |
|--|---|



**Screwdrivers Comfort Line VDE**

red insulated blade, with black tip, multicomponent handle, red/yellow insulated up to 1000V AC, GS approved

- 7 VDE Assortments, 7 parts**
- Art.No.
- 65604**
- 
- 4 x
- 
- 2.5 x 75; 4.0 x 100; 5.5 x 125; 6.5 x 150
- 
- 2 x
- 
- PH 1; PH 2 (optional PZ)
- 
- 1 x
- 
- voltage tester



**Screwdrivers Basic Line VDE**

red insulated blade, with black tip, basic plastic handle, red insulated up to 1000V AC, GS approved

- 8 VDE Assortments, 7 parts**
- Art.No.
- 56080**
- 
- 4 x
- 
- 2.5 x 75; 4.0 x 100; 5.5 x 125; 6.5 x 150
- 
- 2 x
- 
- PH 1; PH 2 (optional PZ)
- 
- 1 x
- 
- voltage tester



**Kistenmacher Screwdriver Sets**

with 1 component handles - red PPC execution

- 9 Mechanical Assortments, 7 parts**
- Art.No.
- 925/WS**
- 
- nickle plated blades, polished
- 
- 4 x
- 
- 3.0 x 75; 4.0 x 100; 5.5 x 125; 7 x 150
- 
- 3 x
- 
- PH 0; PH 1; PH 2



**10 VDE/GS Assortments, 6 parts** Art.No. **926/VDE6**

red insulated blades

- 3 x
- 
- 2.5 x 75; 4.0 x 100; 5.5 x 125
- 
- 2 x
- 
- PH 1; PH 2
- 
- 1 x
- 
- voltage tester 3,0

**11 VDE/GS Assortments, 7 parts** Art.No. **926/VDE**

red insulated blades

- 4 x
- 
- 2.5 x 75; 4.0 x 100; 5.5 x 125; 6.5 x 150
- 
- 2 x
- 
- PH 1; PH 2
- 
- 1 x
- 
- voltage tester 3,0







**1 HSS DIN 338 N Standard Finish**

straight shank twist drills, short series, right hand, roll forged, steam tempered, 118° universal point shape; packing in paper or plastic bags of 10 pcs

**2 HSS G DIN 338 N Bright Finish**

straight shank twist drills, short series, right hand, ground from solid, 130° split point; packing in paper or plastic bags of 10 pcs

**3 HSS CO DIN 338 N Cobalt Finish**

straight shank twist drills, short series, right hand, 5 % Co, ground from solid packing in paper or plastic bags of 10 pcs

**4 HSS DIN 340 N Long Series**

straight shank twist drills, right hand, roll forged, steam tempered, 118° universal point shape; packing in paper or plastic bags of 10 pcs

**5 HSS Autobody Double Ended N**

right hand, ground from solid, bright finish, 130° split point; packing in paper or plastic bags of 10 pcs

**6 HSS DIN 345 N**

morse taper shank twist drills, right hand; steam tempered, 118° split point; individually packed in plastic tubes

1		2		3		4		5		6		6		6	
Ø mm	Art.No.	Art.No.	Art.No.	Art.No.	Art.No.	Art.No.	Art.No.	Ø mm	Art.No.	Ø mm	Art.No.	Ø mm	Art.No.	Ø mm	Art.No.
1.0	2000010	2700010	2900010	2340010	3.0	223000	10.0	2345100	25.5	2345255	40.5	2345405			
1.5	2000015	2700015	2900015	2340015	3.1	223100	10.5	2345105	26.0	2345260	41.0	2345410			
2.0	2000020	2700020	2900020	2340020	3.2	223200	11.0	2345110	26.5	2345265	41.5	2345415			
2.5	2000025	2700025	2900025	2340025	3.3	223250	11.5	2345115	27.0	2345270	42.0	2345420			
3.0	2000030	2700030	2900030	2340030	3.3	223300	12.0	2345120	27.5	2345275	42.5	2345425			
3.5	2000035	2700035	2900035	2340035	3.5	223500	12.5	2345125	28.0	2345280	43.0	2345430			
4.0	2000040	2700040	2900040	2340040	4.0	224000	13.0	2345130	28.5	2345285	43.5	2345435			
4.5	2000045	2700045	2900045	2340045	4.1	224100	13.5	2345135	29.0	2345290	44.0	2345440			
5.0	2000050	2700050	2900050	2340050	4.2	224200	14.0	2345140	29.5	2345295	44.5	2345445			
5.5	2000055	2700055	2900055	2340055	4.5	224500	14.5	2345145	30.0	2345300	45.0	2345450			
6.0	2000060	2700060	2900060	2340060	4.8	224800	15.0	2345150	30.5	2345305	45.5	2345455			
6.5	2000065	2700065	2900065	2340065	4.9	224900	15.5	2345155	31.0	2345310	46.0	2345460			
7.0	2000070	2700070	2900070	2340070	5.0	225000	16.0	2345160	31.5	2345315	46.5	2345465			
7.5	2000075	2700075	2900075	2340075	5.1	225100	16.5	2345165	32.0	2345320	47.0	2345470			
8.0	2000080	2700080	2900080	2340080	5.2	225200	17.0	2345170	32.5	2345325	47.5	2345475			
8.5	2000085	2700085	2900085	2340085			17.5	2345175	33.0	2345330	48.0	2345480			
9.0	2000090	2700090	2900090	2340090			18.0	2345180	33.5	2345335	48.5	2345485			
9.5	2000095	2700095	2900095	2340095			18.5	2345185	34.0	2345340	49.0	2345490			
10.0	2000100	2700100	2900100	2340100			19.0	2345190	34.5	2345345	49.5	2345495			
11.0	2000110	2700110	2900110	2340110			19.5	2345195	35.0	2345350	50.0	2345500			
12.0	2000120	2700120	2900120	2340120			20.0	2345200	35.5	2345355	51.0	2345510			
13.0	2000130	2700130	2900130	2340130			20.5	2345205	36.0	2345360	52.0	2345520			
14.0	2000140	2700140	2900140	2340140			21.0	2345210	36.5	2345365	53.0	2345530			
15.0	2000150	2700150	2900150	2340150			21.5	2345215	37.0	2345370	54.0	2345540			
16.0	2000160	2700160	2900160	2340160			22.0	2345220	37.5	2345375	55.0	2345550			
17.0	2000170	2700170	2900170	2340170			22.5	2345225	38.0	2345380	56.0	2345560			
18.0	2000180	2700180	2900180	2340180			23.0	2345230	38.5	2345385	57.0	2345570			
19.0	2000190	2700190	2900190	2340190			23.5	2345235	39.0	2345390	58.0	2345580			
20.0	2000200	2700200	2900200	2340200			24.0	2345240	39.5	2345395	59.0	2345590			
							24.5	2345245	40.0	2345400	60.0	2345600			
							25.0	2345250							

**1 Masonry DIN 8039 Galvanized**

masonry drill, high temperature brazed tungsten carbide tip, rolled flute, for rotary and percussion; individually packed in PVC wallet

**1A standard length****1B 150 mm extra long****1C 200 mm extra long****2 Concrete - Saphir**

masonry drill for percussion, high temperature brazed tungsten carbide tip, sand blasted, for concrete, natural stone, brick and marble; individually packed in PVC wallet

**2A standard length****2B 150 mm extra long****2C 200 mm extra long****3 Granite - Rubin**

heavy duty hammer drill, high temperature brazed tungsten carbide tip, precision milled bicolor finish, for granite, marble and concrete; individually packed in PVC wallet

**3A standard length****3B 150 mm extra long****3C 200 mm extra long****4 Masonry Drills Long Version**

masonry drill, high temperature carbide tip, sand blasted, rolled flute, rotary and percussion, individually packed in PVC wallet

**4A length 400 mm****4B length 600 mm**

Ø mm	1A Art.No.	1B Art.No.	1C Art.No.	2A Art.No.	2B Art.No.	2C Art.No.	3A Art.No.	3B Art.No.	3C Art.No.	4A Art.No.	4B Art.No.
3.0	3000T030			3500T030			3400T030				
4.0	3000T040			3500T040			3400T040				
5.0	3000T050	3150T050	3200T050	3500T050	3510T050	3520T050	3400T050	3410T050	3420T050		
5.5	3000T055	3150T055	3200T055	3500T055			3400T055				
6.0	3000T060	3150T060	3200T060	3500T060	3515T060	3520T060	3400T060	3415T060	3420T060	4800T060	
6.5	3000T065	3150T065	3200T065	3500T065	3515T065	3520T065	3400T065	3415T065	3420T065	4800T065	
7.0	3000T070	3150T070	3200T070	3500T070	3515T070	3520T070	3400T070	3415T070	3420T070		
8.0	3000T080	3150T080	3200T080	3500T080	3515T080	3520T080	3400T080	3415T080	3420T080	4800T080	4900T080
9.0	3000T090			3500T090			3400T090				
10.0	3000T100	3150T100	3200T100	3500T100	3515T100	3520T100	3400T100	3415T100	3420T100	4800T100	4900T100
11.0	3000T110		3200T110			3520T110	3400T110		3420T110		
12.0	3000T120		3200T120	3500T120		3520T120	3400T120		3420T120	4800T120	4900T120
13.0	3000T130		3200T130	3500T130		3520T130	3400T130		3420T130	4800T130	4900T130
14.0	3000T140		3200T140	3500T140		3520T140	3400T140		3420T140	4800T140	4900T140
15.0	3000T150		3200T150			3520T150	3400T150		3420T150	4800T150	4900T150
16.0	3000T160		3200T160	3500T160		3520T160	3400T160		3420T160	4800T160	4900T160
18.0	3000T180			3500T180			3400T180			4800T180	4900T180
19.0										4800T190	4900T190
20.0	3000T200			3500T200						4800T200	4900T200
22.0	3000T220			3500T220						4800T220	4900T220
24.0	3000T240			3500T240						4800T240	4900T240
25.0	3000T250			3500T250						4800T250	4900T250
26.0										4800T260	4900T260
28.0										4800T280	4900T280
30.0										4800T300	4900T300
32.0										4800T320	4900T320

### 1 Wood Working Drills - Form B

made of high quality CV steel, CNC precision grinded center point, bicolour finish, optimized flute geometry for quick chip ejection, individually packed in PVC wallet



### 2 Wood Working Drills

2A 230 mm  
2B 460 mm



made of high quality CV steel, CNC precision grinded center point, bicolour finish, optimized flute geometry for quick chip ejection, individually packed in PVC wallet

### 3 Forstner Bits Basic

traditional type with center point and two main cutting edges, individually packed in PVC tubes



### 4 Milling Bits - Wood Working

easy self centering, shank 1/4" hex., length 150 mm, individually packed in PVC wallet



**4x Extension for wood milling bit 270 mm**

### 5 Expansive Bits - Wood Working

adjustable up to 45 rep. 75 mm, total length 122 mm, individually packed in PVC wallet



### 6 Glass Drill Bits

galvanized surface, precision dimond ground TC tip, suitable for drilling in plate glass, glass panes, bottle glass, tiles and ceramics; individually packed in PVC wallet



Ø mm	1 Art.No.	2A Art.No.	2B Art.No.	3 Art.No.	4 Art.No.	4x Art.No.	5 Art.No.	6 Art.No.
3.0	6000T030					6127001	up to 45 mm	9500T030
4.0	6000T040						6945001	9500T040
5.0	6000T050							9500T050
6.0	6000T060	6250T060					up to 75 mm	9500T060
7.0	6000T070						6975001	
8.0	6000T080	6250T080	6400T080		6108001			9500T080
9.0	6000T090							
10.0	6000T100	6250T100	6400T100	6500100	6110001			9500T100
11.0	6000T110							
12.0	6000T120	6250T120	6400T120	6500120	6112001			9500T120
13.0	6000T130							9500T130
14.0	6000T140	6250T140	6400T140	6500140	6114001			
15.0	6000T150			6500150				
16.0	6000T160	6250T160	6400T160	6500160	6116001			
18.0	6000T180	6250T180	6400T180	6500180	6118001			
20.0	6000T200	6250T200	6400T200	6500200	6120001			
22.0	6000T220			6500220	6122001			
23.0	6000T230							
24.0	6000T240			6500240	6124001			
25.0	6000T250			6500250				
26.0	6000T260			6500260	6126001			
28.0	6000T270			6500280	6128001			
30.0	6000T300			6500300	6130001			
32.0				6500320	6132001			
34.0				6500340				
35.0				6500350				
36.0				6500360				
38.0				6500380	6138001			
40.0				6500400	6140001			
45.0				6500450				
50.0				6500500				







### 1 Rotary Hammer SDS-plus Drill Bits – 4 PLUS

for rotary drills between 2 and 4 kg with SDS plus chuck, size 4 mm with std. carbide tip size 28 - 32 mm, with ZENTROH 4-cutters pls. refer to item no. 3



### 2 4-Cutter Rotary Hammer SDS-max Drill Bits – Zentro

for rotary drills of min. 5 kg with SDS max chuck. size 12 - 15 mm available with 2-cutters



### 3 4-Cutter Rotary Hammer SDS-plus Drill Bits – Zentro

for rotary drills between 2 and 4 kg with SDS plus chuck



Length 1			Length 2			Length 3		
Ø mm	(mm)	Art.No.	Ø mm	(mm)	Art.No.	Ø mm	(mm)	Art.No.
4.0	110	2400	9.5	160	2481	15	450	2459
4.0	160	2499	10	110	2427	16	160	2460
5.0	110	2401	10	160	2428	16	210	2461
5.0	140	2402	10	210	2429	16	260	24111
5.0	160	2403	10	260	2430	16	310	2462
5.0	210	2404	10	310	2431	16	450	2463
5.0	310	2475	10	350	2432	16	600	2464
5.5	110	2405	10	450	2433	16	800	2465
5.5	160	2406	10	600	2434	16	1000	2466
5.5	210	2476	10	800	2435	17	210	2467
5.5	260	2477	10	1000	2436	17	450	2495
5.5	310	2472	11	160	2437	18	200	2336
6.0	110	2407	11	210	2482	18	300	2394
6.0	160	2408	11	260	2438	18	450	2354
6.0	210	2409	11	310	2483	18	600	2384
6.0	260	2410	12	160	2439	18	1000	230128
6.0	310	2474	12	210	2440	19	200	2337
6.0	460	24014	12	260	2441	19	450	2338
6.5	110	2411	12	310	2442	20	200	2339
6.5	160	2412	12	360	2484	20	300	2355
6.5	210	2478	12	450	2443	20	450	2340
6.5	260	2413	12	600	2444	20	600	2371
6.5	310	2479	12	1000	2445	20	1000	230102
7.0	110	2415	13	160	2446	22	250	2341
7.0	160	2416	13	210	2485	22	450	2342
7.0	210	2417	13	260	2447	22	600	230140
7.0	250	2488	13	310	2448	22	1000	230144
8.0	110	2418	14	160	2449	23	250	2343
8.0	160	2419	14	210	2450	23	450	2344
8.0	210	2420	14	260	2451	24	250	2345
8.0	260	2421	14	310	2452	24	450	2346
8.0	310	2480	14	450	2453	25	250	2347
8.0	400	2422	14	600	2454	25	450	2348
8.0	460	2423	14	1000	2455	25	600	230103
8.0	600	2424	15	160	2456	25	1000	230153
9.0	160	2425	15	210	2457	26	250	2349
9.0	210	2426	15	260	2458	26	450	2350
						12	340	3900
						12	540	3901
						14	340	3903
						14	540	3904
						15	340	3905
						15	540	3906
						16	340	4900
						16	540	4901
						18	340	4902
						18	540	4903
						18	920	4937
						20	320	4904
						20	520	4905
						20	920	4906
						20	1320	4957
						22	320	4907
						22	520	4908
						22	920	4909
						22	1320	4952
						24	320	4910
						24	520	4911
						25	320	4912
						25	520	4913
						25	920	4914
						25	1320	4939
						26	520	4934
						28	370	4915
						28	570	4916
						28	670	4917
						28	920	4951
						28	1320	4963
						30	370	4918
						30	570	4919
						32	370	4920
						32	570	4921
						32	920	4922
						32	1320	4940
						35	370	4923
						35	570	4924
						35	670	4925
						35	920	4965
						35	1320	4945
						37	370	4960
						37	570	4946
						37	920	4958
						38	370	4926
						38	570	4927
						40	370	4928
						40	570	4929
						40	920	4930
						40	1320	4941
						45	570	4931
						45	920	4933
						50	570	4964
						52	570	4959
						16	250	4300
						16	450	4301
						18	250	4313
						18	450	4303
						20	250	4304
						20	450	4306
						22	250	4320
						22	450	4307
						24	250	4308
						24	450	4309
						25	250	4321
						25	450	4310
						28	250	4319
						28	450	4311
						30	250	4323
						30	450	4312
						32	450	4318

**1 Concrete Core Cutter - SDS-max Shank**



for rotary hammer drills weighing 5 kg or more with SDS-max or 2-slot chuck; simple and efficient handling due to one-piece tool design; chuck of adapters and centring drills is no longer necessary



**2 Hollow Hammer Core Bits**



with integrated SDS-max shank and centering drill bit taper 1:20 for Rotary Hammer drills of min. 5 kg with SDS max chuck



**3 Center Drill Bits - Taper Shank 1:20**

10 x 120 mm

Art.No. **1143**



**4 Drift Keys**

Art.No. **7006**



**5 Adapters for 3-Jaw-Drill Chucks**

thread 1/2" – 20UNF to SDS plus shank

Art.No. **6352**



**6 Adapters for SDS-plus Rotary Hammer Drill Bits**

from SDS-max shank to SDS plus shank

Art.No. **6363**



**7 Chisels**



**7A with SDS-plus shank**

for rotary hammer drills with SDS-plus chuck



**7B with SDS-max shank**

for rotary and chisel hammer drills with SDS-max chuck

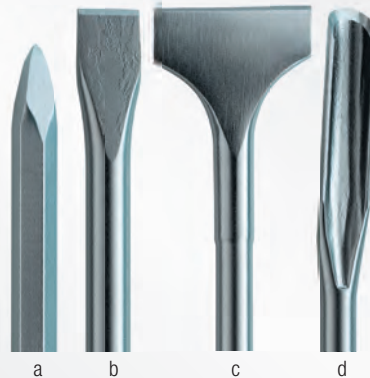

Ø mm	Length (mm)	<b>1</b> Art.No.	Ø (mm)	Length (mm)	<b>2</b> Art.No.	Type	Length (mm)	<b>7</b> Art.No.
<b>40</b>	310	<b>7330</b>	<b>40</b>	290	<b>7101</b>			<b>7A</b>
<b>40</b>	550	<b>7331</b>	<b>40</b>	550	<b>7102</b>	<b>a pointed</b>	250	<b>5124</b>
<b>45</b>	310	<b>7332</b>	<b>50</b>	290	<b>7103</b>	<b>b flat</b>	250	<b>5129</b>
<b>45</b>	550	<b>7333</b>	<b>50</b>	550	<b>7104</b>	<b>c scaling</b>	250	<b>5134</b>
<b>45</b>	990	<b>7342</b>	<b>68</b>	290	<b>7105</b>	<b>d hollow</b>	250	<b>5135</b>
<b>55</b>	310	<b>7336</b>	<b>68</b>	550	<b>7106</b>			<b>7B</b>
<b>55</b>	550	<b>7337</b>	<b>80</b>	290	<b>7107</b>	<b>a pointed</b>	280	<b>5301</b>
<b>55</b>	990	<b>7343</b>	<b>80</b>	550	<b>7108</b>		400	<b>5302</b>
<b>65</b>	310	<b>7338</b>	<b>90</b>	290	<b>7109</b>		600	<b>5303</b>
<b>65</b>	550	<b>7339</b>	<b>90</b>	550	<b>7110</b>	<b>b flat</b>	280	<b>5304</b>
<b>65</b>	990	<b>7344</b>	<b>100</b>	290	<b>7111</b>		400	<b>5305</b>
<b>80</b>	310	<b>7340</b>	<b>100</b>	550	<b>7112</b>		600	<b>5306</b>
<b>80</b>	550	<b>7341</b>	<b>125</b>	550	<b>7113</b>	<b>c scaling</b>	400	<b>5307</b>
<b>80</b>	990	<b>7345</b>	<b>150</b>	550	<b>7114</b>		300	<b>5308</b>
							350	<b>5309</b>
						<b>d hollow</b>	300	<b>5310</b>

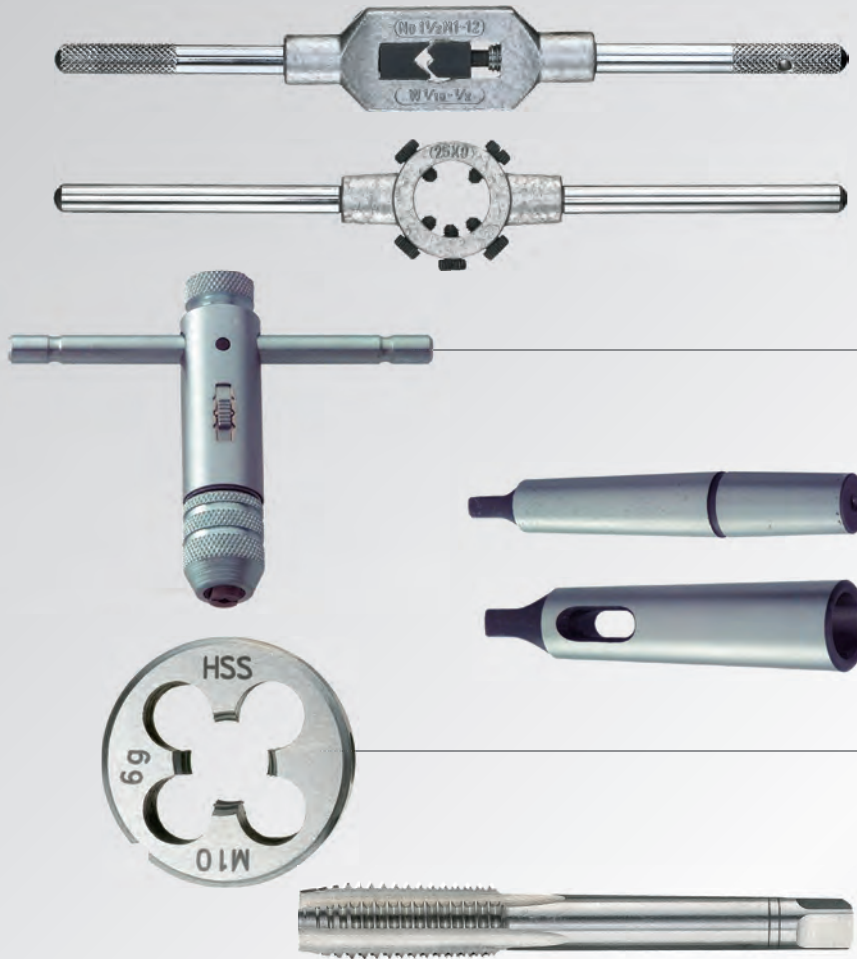

## 1 Adjustable Tap Wrenches (No. 130)

zinc die cast - DIN 1814

## 2 Die Stocks

zinc die cast

**2A** DIN 225/DIN EN 22568 (No. 150)

compatible die size DIN 223

**2B** inch (No. 160)

## 3 Tap Wrenches with Ratchet (No. 100)

for right and left hand turn

## 4 Drill Chuck Arbors (No. 42)

hardened all over and ground

MK = machine capacity

B = chuck capacity

## 5 Morse Taper Drill Sleeves DIN 238 (No. 45)

hardened all over and ground

MK = machine capacity

## 6 Round Dies

**6A** metric ISO thread DIN 223 (No. 6002)

**6B** whitworth thread BS 84 (No. 6302)

## 7 Hand Taps (No. 4103)

metric - fine ISO - thread DIN 13

M3 to M20 all sizes available

	Art.No.	Compatible Tap Size	Ø (mm/inch)	Length (mm)	Art.No.	Size	Nominal Width	DIN 223 o/d. mm
<b>1</b>	130/0	M 1-8 - 1/16-1/4"	2.0 - 5.0		<b>5</b>	45/0201	MK 2 x 1	
	130/1	M 1-10 - 1/16-3/8"	2.0 - 6.3			45/0302	MK 3 x 2	
	130/1.12	M 1-12 - 1/16-1/2"	2.1 - 8.0			45/0403	MK 4 x 3	
	130/2	M 4-12 - 5/32-1/2"	3.0 - 9.0			45/0504	MK 5 x 4	
	130/3	M 5-20 - 7/32-3/4"	4.9 - 12		<b>6A</b>	6002/03	M 3 x 0.5	20 x 05
	130/4	M 9-27 - 7/16-1"	5.5 - 16			6002/04	M 4 x 0.7	20 x 05
	130/5	M 13-32 - 1/2-1.1/4"	7.0 - 20			6002/06	M 6 x 1.0	25 x 07
<b>2A</b>	150/2005	M 03-04 - BSW 1/8-5/32"	20 x 5			6002/08	M 8 x 1.25	25 x 09
	150/2007	M 4.5-06 - BSW 3/16-1/4"	20 x 7			6002/10	M 10 x 1.5	30 x 11
	150/2509	M 07-09 - BSW 5/16"	25 x 9		6002/12	M 12 x 1.75	38 x 14	
	150/3011	M 10-11 - BSW 3/8-7/16"	30 x 11		6002/14	M 14 x 2.0	38 x 14	
	150/3814	M 12-14 - BSW 1/2-9/16"	38 x 14		6002/16	M 16 x 2.0	45 x 18	
	150/4518	M 16-20 - BSW 5/8-13/16"	45 x 18		6002/18	M 18 x 2.5	45 x 18	
	150/5522	M 55-22 - BSW 7/8-1"	55 x 22		6002/20	M 20 x 2.5	45 x 18	
<b>2B</b>	160/0001	25.4 x 9.5mm - 1 x 3/8"	1"		<b>6B</b>	6302/014	BSW 1/4 x 20	20 x 07
	160/0112	38.1 x 12.7mm - 1.1/2 x 1/2"	1.1/2"			6302/516	BSW 5/16 x 18	25 x 09
	160/0002	50.8 x 15.9mm - 2 x 5/8"	2"			6302/038	BSW 3/8 x 16	30 x 11
	160/0212	63.5 x 19.0mm - 2.1/2-3/4"	2.1/2"			6302/716	BSW 7/16 x 14	30 x 11
<b>3</b>	100/01	M 03-10 - 1/8-3/8"		85	6302/012	BSW 1/2 x 12	38 x 14	
	100/02	M 05-12 - 7/32-1/2"		100	6302/058	BSW 5/8 x 11	45 x 18	
	100/10	M 03-10 - 1/8-3/8"		250	6302/034	BSW 3/4 x 10	45 x 18	
	100/20	M 05-12 - 7/32-1/2"		300				
<b>4</b>	42/0216	MK2 - B16						
	42/0316	MK3 - B16						





- 1 Glass Cutter  
SILBERSCHNITT**  
for glass thickness of 3 to 10 mm. 6 cutting wheels made of alloyed steel and tempered by a patented method guarantee high cutting quality and long service life. Turrets and cutting heads are nickel plated.  
Art.No. **100.0**

- 2 Carbide Glass Cutters**  
especially suitable for thick and hard glass  
wooden handle · replaceable, tempered turret with carbide wheel Ø 5 mm · especially selected carbide metal guarantees high wear-resistance  
Art.No. **400.0**
- 3 Carbide Glasses and Tile Cutters**  
cutting angle 135°  
ergonomically shaped, plastic handle especially suitable to cut tiles requiring high cutting pressure  
- tempered turret with one carbide wheel 5 mm  
Art.No. **410.0**



- 4 Spare Turrets with 6 Steel Wheels**  
suitable for all SILBERSCHNITT glass cutters as well as circle cutters BO 501.0 and BO 510.0 - 516.0  
Art.No. **101.0**
- 5 Spare Wheels**  
stainless steel · specially tempered suitable for all SILBERSCHNITT glass and circle cutters  
**5A** Art.No. **102.0** in practical dispenser of 10 doz  
**5B** Art.No. **102.1** in dozens on a needle in a plastic bag



- 6 Oil Glass Cutters**  
original TOPLIFE quality at an especially good value for money · brass handle with finger grip  
**6A** Art.No. **4000.0** brass, wide head, 5 in a box  
**6B** Art.No. **4000.1** brass, narrow head, 5 in a box  
**6C** Art.No. **4001.0** plastic, wide head, 5 in a box  
**6D** Art.No. **4001.1** plastic, narrow head, 5 in a box



- 8 JOB0 Glass Cutters**  
6 cutting wheels made of special steel, round wooden handle, straight edge stand-off distance 2.5 mm  
Art.No. **320.0**

- 9 JOKRA Glass Cutters**  
6 replaceable cutting wheels made of special, high quality steel, straight edge stand-off distance 2.5 mm  
Art.No. **360.0**

- 7 Cutting Heads**  
for all SILBERSCHNITT oil glass cutters · wide or narrow plate · cutting angle 138°  
**7A** Art.No. **4010.1** narrow cutting head  
**7B** Art.No. **4010.0** wide plate



- 10 Glass Cutters**  
rounded wooden handle · with one steel wheel · straight edge stand-off distance 1.5 mm · cutting angle 130°  
Art.No. **200.1**

- 11 Glass Cutters, metal**  
all-metal · ball-end · with one steel wheel  
· straight edge stand-off distance 2.5 mm  
Art.No. **230.0**

- 12 Carbide Glass Cutters**  
all-metal · ball-end · with a specially wear-resistant carbide wheel · cutting angle 135°  
· straight edge stand-off distance 2.5 mm  
Art.No. **260.0**

- 13 Glaziers' diamonds**  
for glass thickness 3-12 mm  
Art.No. **50 055 00**





**1 VERIBOR Suction Lifter blue lines**

the strong durability of aluminium combined with synthetic material is a trademark of this suction lifter - suitable for all materials such as glass, plastic, metal, coated wood and marble

	Art.No.	load capacity	
<b>1A</b>	<b>603.0BL</b>	100 kg	3 cup
<b>1B</b>	<b>602.0BL</b>	70 kg	2 cup - transverse handle
<b>1C</b>	<b>602.4BL</b>	60 kg	2 cup - lengthwise handle
<b>1D</b>	<b>600.0BL</b>	30 kg	1 cup - one hand operation - Ø 120 mm

**2 VERIBOR Suction Lifters**

traditional design of strong aluminium body - suitable for all materials such as glass, plastic, metal, coated wood and marble

	Art.No.	load capacity	
<b>2A</b>	<b>603.0</b>	100 kg	3 cup
<b>2B</b>	<b>602.0</b>	70 kg	2 cup - transverse handle
<b>2C</b>	<b>602.4</b>	60 kg	2 cup - lengthwise handle
<b>2D</b>	<b>600.0</b>	30 kg	1 cup - one hand operation - Ø120 mm
<b>2E</b>	<b>600.5</b>	20 kg	1 cup - one hand operation - Ø 90 mm

**4 JOBBO Carpet Grippers**

- aluminium -  
for carpeted double floors  
2 cup - lengthwise handle  
Art.No. **619.9**

**3 VERIBOR Suction Lifters, plastic construction**

suitable for all materials with smooth, flat, airtight surfaces

	Art.No.	load capacity	
<b>3A</b>	<b>602.1</b>	60 kg	2 cup - lengthwise handle
<b>3B</b>	<b>600.1</b>	30 kg	1 cup - one hand operation - Ø 120 mm

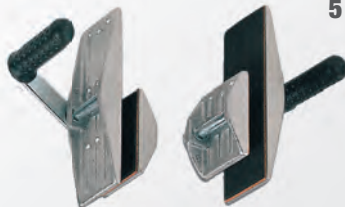
**5 Glass Carrying Device Tragboys**

suitable for transporting all kinds of materials · 80 kg carrying capacity per pair  
· the load is held firmly between two non-slip, rubber-lined clamps  
· the heavier the load, the stronger the clamping pressure,  
· opening range max. 25mm  
Art.No. **50 001 01**

**6 Glass Carrying Gloves**

latex coated · firm grip · latex coated · size XL

<b>6A</b>	Art.No. <b>50 075 00</b>	with canvas gauntlet
<b>6B</b>	Art.No. <b>50 075 01</b>	with knitted gauntlet



Opening (mm)	Rail (mm)	Throat Depth (mm)	1A Art.No.	1B Art.No.
100	15 x 5	50	500-100	500+100
150	15 x 5	50	500-115	500+115
200	15 x 5	50	500-119	500+119
120	22 x 6	80	503-012	503+012
160	22 x 6	80	503-016	503+016
200	22 x 6	80	503-020	503+020
250	22 x 6	80	503-025	503+025
300	22 x 6	80	503-030	503+030
400	22 x 6	80	503-040	503+040
500	22 x 6	80	503-050	503+050
600	22 x 6	80	503-060	503+060
200	30 x 8	100	503-120	503+120
250	30 x 8	100	503-125	503+125
300	30 x 8	100	503-130	503+130
400	30 x 8	100	503-140	503+140
500	30 x 8	100	503-150	503+150
600	30 x 8	100	503-160	503+160
800	30 x 8	100	503-180	503+180
1000	30 x 8	100	503-199	503+199
200	30 x 8	120	504-020	504+020
250	30 x 8	120	504-025	504+025
300	30 x 8	120	504-030	504+030
400	30 x 8	120	504-040	504+040
500	30 x 8	120	504-050	504+050
600	30 x 8	120	504-060	504+060
800	30 x 8	120	504-080	504+080
1000	30 x 8	120	504-100	504+100
1250	30 x 8	120	504-125	504+125
1500	30 x 8	120	504-150	504+150
300	35 x 9	140	504-303	504+303
400	35 x 9	140	504-304	504+304
500	35 x 9	140	504-305	504+305
600	35 x 9	140	504-306	504+306
800	35 x 9	140	504-308	504+308
1000	35 x 9	140	504-310	504+310
1250	35 x 9	140	504-312	504+312
1500	35 x 9	140	504-315	504+315
2000	35 x 9	140	504-320	504+320

Clamping Capacity	Throat Depth	2
28	25	420-028
53	38	420-053
78	50	420-078
105	60	420-105
130	70	420-130
155	76	420-155
206	86	420-206

Length	3A	3B
1000	TC100	TB100
1200	TC120	TB120
1500	TC150	TB150
2100	TC210	TB210
2500	TC250	TB250

**1 KISTENMACHER brand F-clamps**  
series UNIVERSA fixed and sliding arm made of cast steel  
**1A** with wooden handle  
**1B** with 2 component handle



**2 KISTENMACHER brand C-clamps**  
made of high grade, drop forged steel-galvanized with fine thread spindle



**3 BESSEY Door Clamps**  
with T-profile, colour: black

**3A** 50 x 50 x 6 mm, jaw dimensions 80 x 48 mm, with stopping bolt, Type: TC - force 18.000N  
**3B** 40 x 40 x 5 mm, jaw dimensions 66 x 43 mm, with locking bolt, Type: TB - force 14.000N







**1 Handsaws**

with closed wooden handle, lacquered, rivetted

**2 Back Saws**

with closed wooden handle, lacquered, rivetted

**3 Pruning Saws**

with wooden handle, thickness of blade 0.7 mm

**4 Baghdad Handsaws**

with wooden handle, blade blue

**5 Nest of Saws**

5 blades per set, with exchangeable sawblades,

**5A with open wooden handle** Art.No. **7SA2****5B with closed plastic handle** Art.No. **7SA1****6 TCT Handsaws**

with carbide tipped teeth and closed wooden handle

**7 Junior Hacksaws**with red beechwood handle,  
Zinc-plated frame made of 6 mm round steel,  
fitted with a PUK universal saw bladelength 290 mm Art.No. **305100****8 Metal Bar Saws**black powder coated with beechwood handle,  
bi-metal sawblade 300 mm / 24 tpilength 520 mm Art.No. **B31102****9 Bow Saws**symmetrical shape, hardpoint, quick  
release, for wet and dry types of woodslength 530 mm Art.No. **2053445530**length 760 mm Art.No. **2053445760**

1			2			4		
Length (mm / inch)	tpi	Art.No.	Length (mm / inch)	tpi	Art.No.	Length (mm / inch)	tpi	Art.No.
300 / 12"	8	612/300	250 / 10"	12	111-250	400 / 16"	7	119/400
350 / 14"	8	612/350	300 / 12"	12	111-300	450 / 18"	7	119/450
400 / 16"	7	612/400	350 / 14"	12	111-350			
450 / 18"	7	612/450						
500 / 20"	7	612/500						
550 / 22"	7	612/550						
			3					
			300 / 12"	5	631/300	700 / 28"	17	903/17
			350 / 14"	5	631/350	700 / 28"	34	903/34
			400 / 16"	5	631/400			



**1 Xtract Garden Saw**

efficiently saws fresh wood - with handy belt clip which retracts when in use - SoftGrip™ handle ensures a safe grip cuts on the pull stroke

**2 Xtract Builders Saw**

fine teeth for cutting wood strips and boards - with handy belt clip which retracts when in use - SoftGrip™ handle ensures a safe grip cuts on the pull stroke

**3 Fixed Blade Saw**

large cutting capacity up to 120mm - efficient tooth profile enabling fast and accurate sawing - SoftGrip™ ergonomic curved handle for comfortable use - cuts on the pull stroke

	Art.No.	cutting capacity (cm)	length (mm)	weight (gr)
<b>1</b>	123880-SW75	12	330	230
	123870-SW73	7	223	130
<b>2</b>	123860-SW72	7	223	127
<b>3</b>	123840-SW84	12	490	410

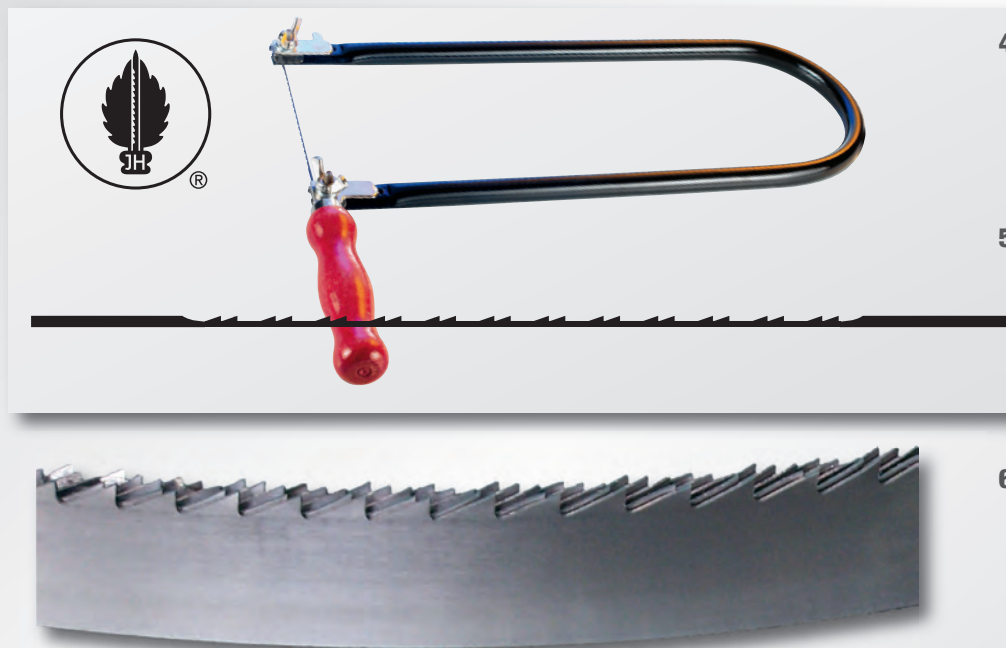

**4 Fretsaw Frames**

extremely solid, made of 13 mm round steel, black coated with red beechwood handle  
Length 345 mm / 13.8 inch  
Art.No. **490001**

**5 Fretsaw Blades**

for wood, A-c: packing with yellow cover at both ends, D-F: with light blue cover at both ends

**6 Bandsaw Blades for Wood**

made of German special steel C 75, hardened, polished, toothed NV (A)  
on rolls of 22, 25 or 30 m  
available in set/unset  
and sharpened/unsharpened versions

No.	5A	5B	5C	5D	5E	5F	Width (mm)	Thickness (mm)	Tooth-pitch (mm)	6 Art.No.
	TAIFUN double teeth	TAIFUN skip teeth	GOLIATH regular teeth	CRAFTA double teeth	CRAFTA skip teeth	CRAFTA regular teeth				
<b>mixed</b>	501920	511920	521920	601920	611920	621920	<b>6</b>	0,6	5	<b>060605</b>
<b>2/0</b>	502020	510020	522020	602020	610020	622020	<b>12</b>	0,6	6	<b>120606</b>
<b>0</b>	500020	510120	520020	600020	610120	620020	<b>15</b>	0,6	6	<b>150606</b>
<b>1</b>	500120	510220	520120	600120	610220	620120	<b>20</b>	0,6	8	<b>200608</b>
<b>2</b>	500220	510320	520220	600220	610320	620220	<b>25</b>	0,6	8	<b>250608</b>
<b>3</b>	500320	510420	520320	600320	610420	620320	<b>25</b>	0,7	8	<b>250708</b>
<b>4</b>	500420	510520	520420	600420	610520	620420	<b>30</b>	0,7	9	<b>300709</b>
<b>5</b>	500520	510620	520520	600520	610620	620520	<b>35</b>	0,8	10	<b>350810</b>
<b>7</b>	500720	510720	520720	600720	610720	620720	<b>40</b>	0,8	10	<b>400810</b>
<b>9</b>	500920	510920	520920	600920	610920	620920	<b>50</b>	0,9	12	<b>500912</b>
<b>11</b>	501120	511120	521120	601120	611120	621120				
<b>12</b>		511220			611220					

## 1 Planer Blades

**1A chrome-vanadium steel (CV)**

**1B C75 48-50 HRc chrome-vanadium steel (CV)**

## 2 Diamond Blades for Concrete - Type B1 Construction

reasonable priced blade for concrete as well as construction-site materials  
good cutting performance and service life

height of segments 7 mm

## 3 Diamond Blades for Granite - Type G2

special diamond blade with comparably soft bonding  
for cutting granite and all other kinds of hard stone  
- recipe with shock resistant diamonds for high cutting efficiency

height of segments 10 mm

## 4 Diamond Blades for Asphalt - Type A2

very good cutting performance and service-life whilst cutting asphalt  
and green concrete - laser welded core-guard-segments preventing  
the segment being fast worn out and early loss of segments

height of segments 10 mm

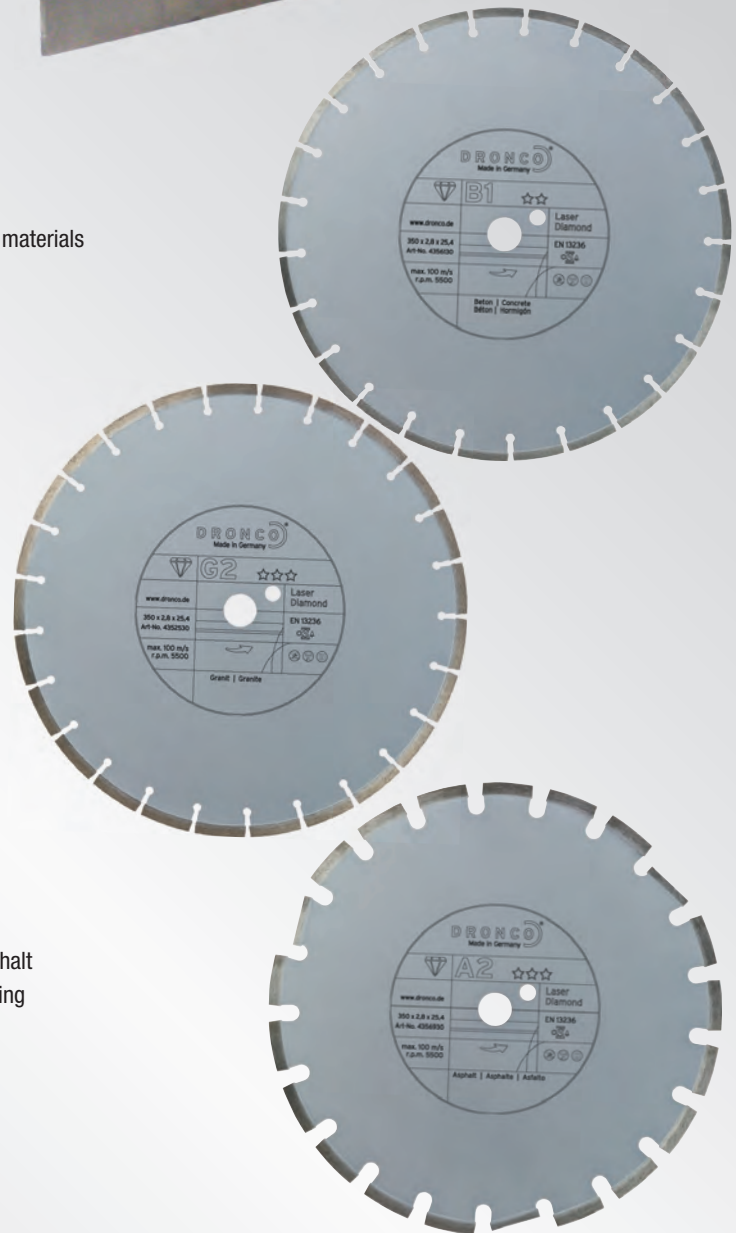

Size (inch / mm)	<b>1A</b> Art.No.	<b>1B</b> Art.No.	Size (mm)	No. Segments	<b>2</b> Art.No.	<b>3</b> Art.No.	Size (mm)	No. Segments	<b>4</b> Art.No.
10" / 250 x 35 x 3	250353	—	250 x 2.4 x 25.4	17	4256130	4252530	300 x 2.8 x 20.0	18	4306920
12" / 300 x 35 x 3	300353	300353/C	250 x 2.4 x 30.0	17	4256140	4252540	300 x 2.8 x 22.2	18	4306925
14" / 350 x 35 x 3	350353	350353/C	300 x 2.8 x 20.0	21	4306120	4302520	300 x 2.8 x 25.4	18	4306930
16" / 400 x 30 x 3	—	400303/C	300 x 2.8 x 22.2	21	4306125	4302525	300 x 2.8 x 30.0	18	4306940
16" / 400 x 35 x 3	400353	400353/C	300 x 2.8 x 25.4	21	4306130	4302530	350 x 2.8 x 20.0	21	4356920
18" / 450 x 35 x 3	450353	—	300 x 2.8 x 30.0	21	4306140	4302540	350 x 2.8 x 22.2	21	4356925
20" / 500 x 30 x 3	500353	500303/C	350 x 2.8 x 20.0	25	4356120	4352520	350 x 2.8 x 25.4	21	4356930
20" / 500 x 35 x 3	—	500353/C	350 x 2.8 x 22.2	25	4356125	4352525	350 x 2.8 x 30.0	21	4356940
22" / 550 x 35 x 3	550353	—	350 x 2.8 x 25.4	25	4356130	4352530	400 x 3.2 x 25.4	24	4406930
24" / 600 x 30 x 3	—	600303/C	350 x 2.8 x 30.0	25	4356140	4352540	400 x 3.2 x 30.0	24	4406940
24" / 600 x 35 x 3	600353	600353/C	400 x 3.2 x 25.4	28	4406130	4402530	450 x 3.8 x 25.4	26	4456930
			400 x 3.2 x 30.0	28	4406140	4402540	450 x 3.8 x 30.0	26	4456940
			450 x 3.8 x 25.4	32	4456130	4452530	500 x 3.8 x 25.4	30	4506930
			450 x 3.8 x 30.0	32	4456140	4452540	500 x 3.8 x 30.0	30	4506940
			500 x 3.8 x 25.4	36	4506130	4502530	600 x 3.8 x 25.4	36	4606930
			500 x 3.8 x 30.0	36	4506140	4502540	600 x 3.8 x 30.0	36	4606940
			600 x 3.8 x 25.4	42	4606130	4602530			
			600 x 3.8 x 30.0	42	4606140	4602540			

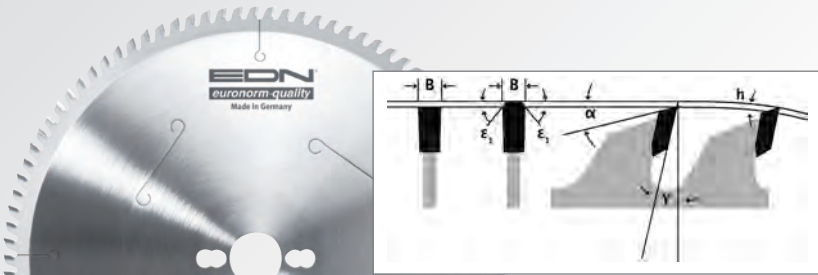
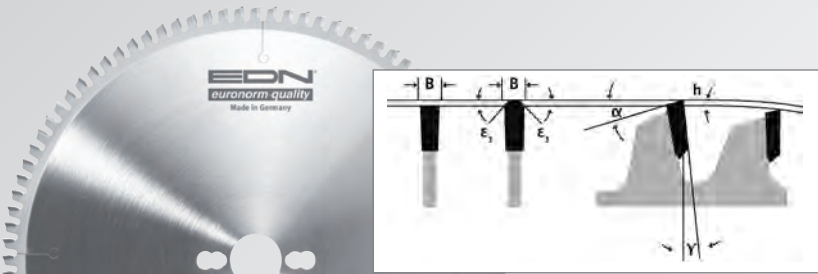
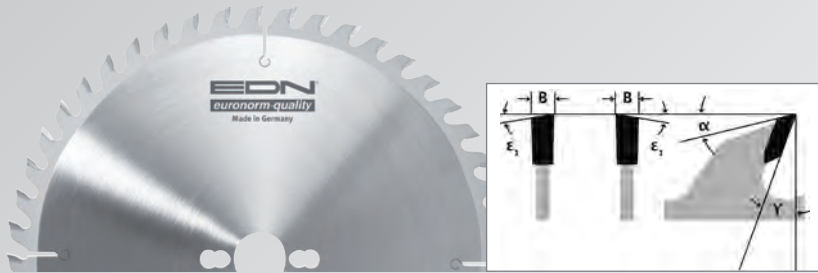

**EDN**<sup>®</sup>  
euronorm quality

## 1 EDN brand Carbide Tipped Circular Sawblades

1A for cutting wood

1B for cutting aluminium - negative teeth

### optionally available in teeth width

- 1) 2.6 / 2.5 mm
- 2) 3.0 mm
- 3) 3.2 mm
- 4) 3.6 mm
- 5) 4.0 mm

## 2 EDN brand Carbide Tipped Circular Sawblades

- Typ 061 VTF

for cutting single- and double-sided  
plastic coated panel materials

Size x Width (mm)	Teeth	1A	1B	Size x Width (mm)	Teeth	1A	1B	Size x Width (mm)	Teeth	1A	1B
		Art.No. 76950...	Art.No. 76956...			Art.No. 76950...	Art.No. 76956...			Art.No. 76950...	Art.No. 76956...
150 x 3.0	24	150024	—	250 x 3.2	40	250040 <sup>2)</sup>	—	400 x 3.6	96	400096 <sup>3)</sup>	40096 <sup>5)</sup>
150 x 3.0	30	150030	—	250 x 3.2	48	250048 <sup>2)</sup>	—	400 x 3.6	108	400108 <sup>3)</sup>	40108 <sup>5)</sup>
150 x 3.0	36	150036	—	250 x 3.2	60	250060 <sup>2)</sup>	250060	400 x 3.6	120	400120 <sup>3)</sup>	40120 <sup>5)</sup>
150 x 3.0	48	150048	—	250 x 3.2	80	250080 <sup>2)</sup>	250080	400 x 3.6	132	400132 <sup>3)</sup>	—
160 x 2.5	36	160036	—	300 x 3.2	28	300028	—	450 x 4.0	66	450066	—
160 x 2.5	48	160048	—	300 x 3.2	36	300036	—	450 x 4.0	72	450072	—
180 x 3.0	24	180024 <sup>1)</sup>	—	300 x 3.2	48	300048	—	450 x 4.0	84	450084	—
180 x 3.0	30	180030 <sup>1)</sup>	—	300 x 3.2	60	300060	—	450 x 4.0	96	450096	450096
180 x 3.0	36	180036 <sup>1)</sup>	—	300 x 3.2	72	300072	300072	450 x 4.0	108	450108	450108
180 x 3.0	42	180042 <sup>1)</sup>	—	300 x 3.2	84	300084	300084	450 x 4.0	120	450120	450120
180 x 3.0	48	180048 <sup>1)</sup>	—	300 x 3.2	96	300096	300096	450 x 4.0	132	450132	450132
180 x 3.0	56	180056 <sup>1)</sup>	—	350 x 3.6	36	350036 <sup>3)</sup>	—	500 x 4.0	72	500072	—
200 x 3.0	34	200034 <sup>1)</sup>	—	350 x 3.6	42	350042 <sup>3)</sup>	—	500 x 4.0	96	500096	—
200 x 3.0	42	200042 <sup>1)</sup>	—	350 x 3.6	48	350048 <sup>3)</sup>	—	500 x 4.2	120	500120	500120
200 x 3.0	48	200048 <sup>1)</sup>	—	350 x 3.6	54	350054 <sup>3)</sup>	—				
200 x 3.0	64	200064 <sup>1)</sup>	—	350 x 3.6	60	350060 <sup>3)</sup>	—				
230 x 3.0	34	230034 <sup>1)</sup>	—	350 x 3.6	72	350072 <sup>3)</sup>	35072 <sup>4)</sup>				
230 x 3.0	42	230042 <sup>1)</sup>	—	350 x 3.6	84	350084 <sup>3)</sup>	35084 <sup>4)</sup>				
230 x 3.0	48	230048 <sup>1)</sup>	—	350 x 3.6	96	350096 <sup>3)</sup>	35096 <sup>4)</sup>				
230 x 3.0	60	230060 <sup>1)</sup>	—	350 x 3.6	108	350108 <sup>3)</sup>	35108 <sup>4)</sup>				
230 x 3.0	64	230064 <sup>1)</sup>	—	350 x 3.6	120	350120 <sup>3)</sup>	35120 <sup>4)</sup>				
230 x 3.0	72	230072 <sup>1)</sup>	—	400 x 3.6	48	400048 <sup>3)</sup>	—				
230 x 3.0	80	230080 <sup>1)</sup>	230080	400 x 3.6	60	400060 <sup>3)</sup>	—				
250 x 3.2	24	250024 <sup>2)</sup>	—	400 x 3.6	72	400072 <sup>3)</sup>	40072 <sup>5)</sup>				
250 x 3.2	30	250030 <sup>2)</sup>	—	400 x 3.6	84	400084 <sup>3)</sup>	—				

2

180 x 3.2	48	061 VTF 180048
200 x 3.2	64	061 VTF 200064
230 x 3.2	72	061 VTF 230072
250 x 3.2	80	061 VTF 250080
300 x 3.2	96	061 VTF 300096
350 x 3.5	108	061 VTF 350108

## 1 Circular Saws

compact, sturdy circular saw with a galvanised saw bench  
- for immediate use due to excellent subassembly  
- ideal for standard sawing work in the home, workshop  
and construction sites - height adjustable  
table size: 810 x 585 mm

### 1A with lever - lever for fast height setting

230V - 2,0 kW Art.No. **OTKSHVH20/230**

400V - 2,5 kW Art.No. **OTKSHVH20/400**

### 1B with crank - precise height setting by scroll

230V - 2,0 kW Art.No. **OTKSHVK20/230**

400V - 2,5 kW Art.No. **OTKSHVK20/400**

### available accessories:

chassis with 2 wheels Art.No. **OZUB 1091**

table extension - 810 x 585 mm Art.No. **OZUB 1063**



## 2 Site Circular Saws

sturdy, all-weather site circular saw with a completely galvanised  
all-steel construction with crane eyelets - powerful for professional  
use on construction sites - table size: 1030 x 750 x 850 mm

230V - 2,0 kW Art.No. **OBK450-20**

400V - 2,5 kW Art.No. **OBK450-30**

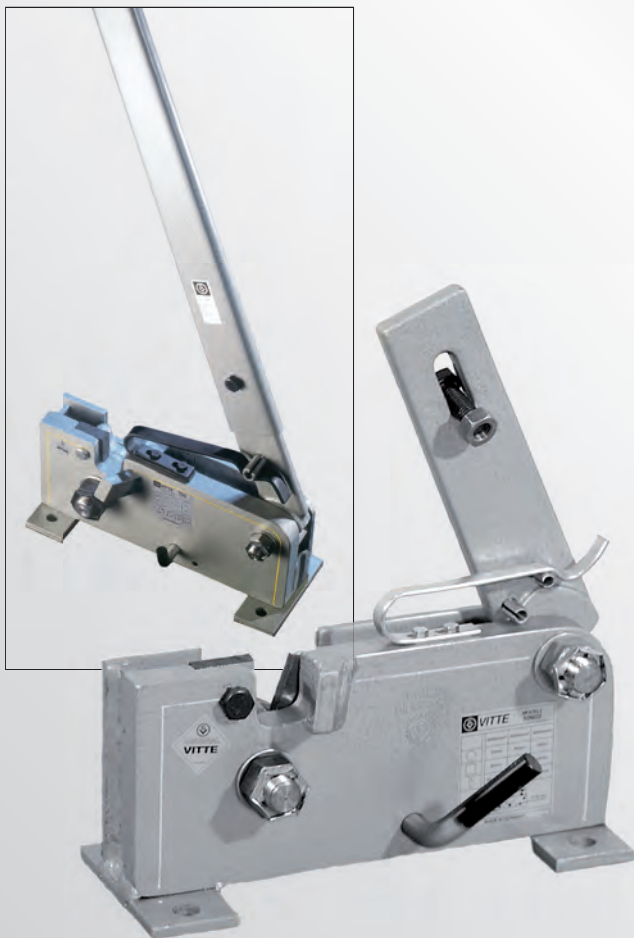

## 3 VITTE brand Concrete Steel Cutters

complete with cutting blades and hand lever  
colour: hammerslag blue

22 mm Art.No. **50/N22** Spare Blades Art.No. **22blade**

28 mm Art.No. **50/N28** Spare Blades Art.No. **28blade**

32 mm Art.No. **50/N32** Spare Blades Art.No. **32blade**

## 4 VITTE brand Plate Shears

complete with cutting blades and hand lever  
colour: hammerslag blue

120 mm Art.No. **3/4R/120** Spare Blades Art.No. **120blade**

160 mm Art.No. **3/5R/160** Spare Blades Art.No. **160blade**

200 mm Art.No. **3/6R/200** Spare Blades Art.No. **200blade**

300 mm Art.No. **3/4L/300** Spare Blades Art.No. **300blade**

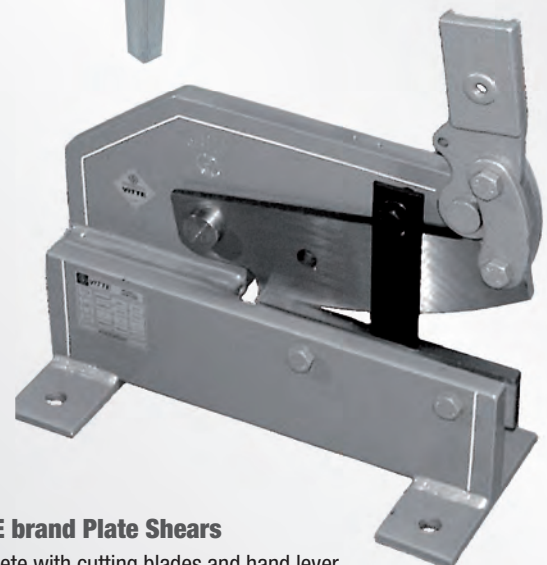



### 1 Grinding Cups for Steel - Type AS

suitable for all angle grinders - coarse grinding works on metal  
grinding cup angle allows work on welding seams  
size 110/90 x 55 mm with bore 22.23 mm

### 2 Grinding Cups for Stone - Type CS

suitable for all angle grinders - working on all types of stone  
high removal rate on natural and synthetic stone  
size 110/90 x 55 mm

2A with bore 22.23 mm

2B with M14 thread

### 3 HERMES brand Vulcanfibre Discs - Type RB 314 fibre

for stone and steel, aluminium oxide  
packed in bundles of 25 pcs per carton

3A without slots, with centre hole

3B with 4 slots

### 4 HERMES brand Vulcanfibre Discs - INOX Type RB 414x Procut

for stainless steel, zirconia alumina  
packed in bundles of 25 pcs per carton

4A without slots, with centre hole

4B with 4 slots



Structure	1 Art.No.	Structure	2A Art.No.	2B Art.No.
AS16Q - coarse	6311000	CS16N - coarse	6311010	6311009
AS24Q - medium	6311001	CS24N - medium	6311011	6311012
AS36Q - fine	6311003	CS36N - medium-fine		6311014
		CS60N - fine	6311016	6311022
		CS80N - fine		6311045
		CS100N - super fine		6311039
		CS120N - super fine	6311019	6311023

Grain	4" / 100 x 16 mm		4.5" / 115 x 22 mm		5" / 125 x 22 mm		7" / 180 x 22 mm	
	3A Art.No.	4A Art.No.	3B Art.No.	4B Art.No.	3B Art.No.	4B Art.No.	3B Art.No.	4B Art.No.
16	100/16	100/16inox	115/16	115/16inox	125/16	125/16inox	180/16	180/16inox
24	100/24	100/24inox	115/24	115/24inox	125/24	125/24inox	180/24	180/24inox
30	100/30	100/30inox	115/30	115/30inox	125/30	125/30inox	180/30	180/30inox
36	100/36	100/36inox	115/36	115/36inox	125/36	125/36inox	180/36	180/36inox
40	100/40	100/40inox	115/40	115/40inox	125/40	125/40inox	180/40	180/40inox
50	100/50	100/50inox	115/50	115/50inox	125/50	125/50inox	180/50	180/50inox
60	100/60	100/60inox	115/60	115/60inox	125/60	125/60inox	180/60	180/60inox
80	100/80	100/80inox	115/80	115/80inox	125/80	125/80inox	180/80	180/80inox
100	100/100	100/100inox	115/100	115/100inox	125/100	125/100inox	180/100	180/100inox
120	100/120	100/120inox	115/120	115/120inox	125/120	125/120inox	180/120	180/120inox





### 1 Hermes brand Backing Pads for Angle Grinders

good scratch pattern due to damping and flexibility of the backing pad, with M14 thread

#### 1A PAD-X - stiff design for grains upto 50

for fibre discs Ø 115 mm Art.No. **116556**

for fibre discs Ø 125 mm Art.No. **34762**

for fibre discs Ø 180 mm Art.No. **21040**

#### 1B PAD-J - flexible design for fine grains

for fibre discs Ø 115 mm Art.No. **51497**

for fibre discs Ø 125 mm Art.No. **68543**

for fibre discs Ø 180 mm Art.No. **18074**



### 2 Hermes brand Flap Discs

with plastic backing pad

Size 4.5" / 115 x 22 mm

#### 2A Type - FL 390 Eco

universally applicable for general metal works

#### 2B Type RB 486 24 YX

special design for cool grinding - especially suitable for grinding stainless steel



### 3 Hermes brand Sanding Papers on Rolls - Type RB 346 J-flex

premium product with a long tool life - high flexible cotton cloth, easy to tear

3A 25 mm x 50 m

3B 50 mm x 50 m



### 4 Hermes brand Hand Sanding Papers - Type WS flex 16

sheets made of very flexible, waterproof latex paper

Size: 230 x 280 mm

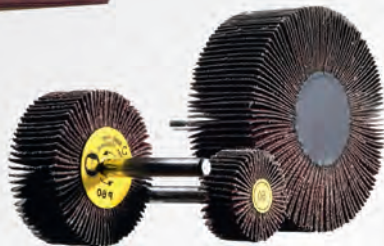

### 5 Hermes brand Flap Wheels - Type FW 340 X

with 6.0 mm shaft - universally applicable

5A 40 x 20 mm

5C 50 x 30 mm

5E 60 x 30 mm

5B 50 x 20 mm

5D 60 x 20 mm

5F 80 x 30 mm

Grain	2A Art.No.	2B Art.No.	3A Art.No.	3B Art.No.	4 Art.No.	5A Art.No.	5B Art.No.	5C Art.No.	5D Art.No.	5E Art.No.	5F Art.No.
36	6010186										
40	6010192	6042407				6013720	6013736	6013745		6013763	6013788
60	6010193	6042408	6008627	6008803	WS/P60	6013721	6013737	6013746	6013758	6013764	6013789
80	6010194	6042409	6008692	6008804	WS/P80	6013722	6013738	6013747	6013759	6013765	
100			6008693	6008805	WS/P100						
120			6008694	6008806	WS/P120	6013724	6013740	6013749	6013760	6013767	6013791
150			6008695	6008807	WS/P150		6013742			6013768	
180			6008696	6008808	WS/P180					6013769	
220			6008697	6008809	WS/P220						
240			6008698	6008810	WS/P240				6013762	6013770	
280			6008699	6008811	WS/P280						
320			6008700	6008812	WS/P320					6013771	
360					WS/P360						
400			6008791	6008814	WS/P400						
500					WS/P500						
600					WS/P600						
800					WS/P800						
1000					WS/P1000						
1200					WS/P1200						
1500					WS/P1500						
2000					WS/P2000						
2500					WS/P2500						

### 1 Allround-Circular Brushes

Universal in surface treatment

**1A Steel wire 0.30 mm**

**1B Brass wire 0.30 mm**

**1C Stainless Steel wire 0.30 mm**

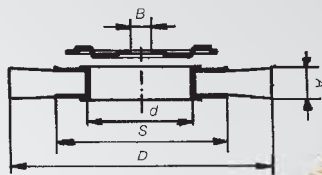

D Ø (mm)	A (mm)	Rows	Hole (min. mm)	Hole (max. mm)	d (mm)	RPM (1/min)	<b>1A</b> Art. No	<b>1B</b> Art. No	<b>1C</b> Art. No
80	16	2	10	20	26	10000	15080233	15080213	15080223
80	24	3	10	20	26	10000	15080333	15080313	15080323
80	32	4	10	20	26	10000	15080433	15080413	15080423
100	18	2	10	20	26	8000	15100233	15100213	15100223
100	26	3	10	20	26	8000	15100333	15100313	15100323
100	34	4	10	20	26	8000	15100433	15100413	15100423
125	22	2	13	35	43	6000	15125233	15125213	15125223
125	33	3	13	35	43	6000	15125333	15125313	15125323
125	44	4	13	35	43	6000	15125433	15125413	15125423
150	22	2	13	35	43	6000	15150233	15150213	15150223
150	33	3	13	35	43	6000	15150333	15150313	15150323
150	44	4	13	35	43	6000	15150433	15150413	15150423
175	26	2	16	60	62	6000	15175233	15175213	15175223
175	38	3	16	60	62	6000	15175333	15175313	15175323
175	50	4	16	60	62	6000	15175433	15175413	15175423
200	25	2	16	60	62	4500	15200233	15200213	15200223
200	38	3	16	60	62	4500	15200333	15200313	15200323
200	50	4	16	60	62	4500	15200433	15200413	15200423
225	22	2	20	80	82	4000	15225233	15225213	15225223
225	35	3	20	80	82	4000	15225333	15225313	15225323
225	46	4	20	80	82	4000	15225433	15225413	15225423
250	24	2	20	80	82	3600	15250233	15250213	15250223
250	36	3	20	80	82	3600	15250333	15250313	15250323
250	48	4	20	80	82	3600	15250433	15250413	15250423
300	33	2	25.4	80	82	3000	15300233	15300213	15300223
300	45	3	25.4	80	82	3000	15300333	15300313	15300323
300	56	4	25.4	80	82	3000	15300433	15300413	15300423
350	33	2	32	100	100	2400	15350233	15350213	15350223
350	45	3	32	100	100	2400	15350333	15350313	15350323
350	57	4	32	100	100	2400	15350433	15350413	15350423
400	34	2	32	100	100	1800	15400233	15400213	15400223
400	46	3	32	100	100	1800	15400333	15400313	15400323
400	58	4	32	100	100	1800	15400433	15400413	15400423

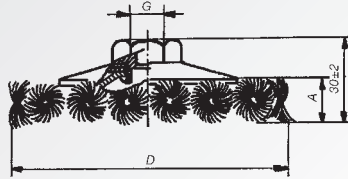
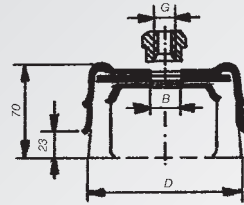
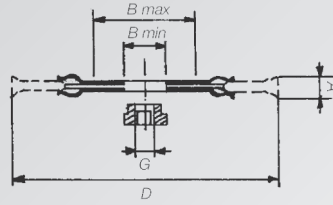

### 1 Pipeline- / Joint-Brushes, knotted

Optimal brushes for pipeline and piping construction

**1A Steel wire 0.50 mm**

**1B Brass wire 0.50 mm**

**1c Stainless Steel wire 0.50 mm**

### 2 Knotted Cup Brushes

High removal rate at high circumferential speed

**2A Steel wire 0.50 mm**

\* We can deliver the brushes with stiffening ring or 6 mm shank on request

**2B Brass wire 0.50 mm**

**2c Stainless Steel wire 0.50 mm**

### 3 Conical Brushes, knotted

Efficient in corners and at edges

**3A Steel wire 0.50 mm**

**3B Brass wire 0.50 mm**

**3c Stainless Steel wire 0.50 mm**

D Ø (mm)	Knots	Bore (mm)	G Thread	Rows	A (mm)	RPM (1/min)	1A Art.No.	Art.No.	1B Art.No.
100	24	22.2	–	–	6	12000	110007350		110007250
100	24	–	M14	–	6	12000	110017350		110017250
115	24	22.2	–	–	6	12000	111507350		111507250
115	24	–	M14	–	6	12000	111517350		111517250
125	40	22.2	–	–	6	12000	112507350		112507250
125	40	–	M14	–	6	12000	112517350		112517250
150	40	22.2	–	–	6	9000	115007350		115007250
150	40	–	M14	–	6	9000	115017350		115017250
178	64	22.2	–	–	6	9000	117807350		117807250
178	64	–	M14	–	6	9000	117817350		117817250
							<b>2A</b>	<b>2B</b>	<b>2c</b>
35*	16	–	M14	1	–	12000	203513350	–	–
45*	16	–	M14	1	–	12000	204513350	–	–
65	18	–	M14	1	–	12000	206516350	206516150	–
80	22	22.2	–	1	–	10500	208004350	208004150	208004250
80	22	–	M14	1	–	10500	208014350	208014150	208014250
100	30	22.2	–	1	–	8500	210004350	210004150	210004250
100	30	–	M14	1	–	8500	210014350	210014150	210014250
120	36	22.2	–	1	–	6500	212004350	212004150	212004250
120	36	–	M14	1	–	6500	212014350	212014150	212014250
							<b>3A</b>		<b>3B</b>
100	18	–	M14	–	13	12000	410014350		410014250
100	22	–	M14	–	13	12000	410012350		–
115	18	–	M14	–	13	12000	411514350		411514250
115	20	–	M14	–	13	12000	411512350		411512250
125	20	–	M14	–	13	12000	412513350		412513250
185	36	–	M14	–	13	4500	418513350		
185	36	22.2	–	–	13	4500	418503350		

**1 Surface Cleaning Brushes, crimped**

Effective on surfaces

**1A Steel wire 0.30 mm**

**1B Brass wire 0.30 mm**

**1c Stainless Steel wire 0.30 mm**

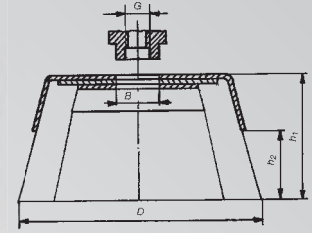

**2 - 4 Shank Brushes, knotted and crimped** For professional use and DIY, with 6 mm shank

**2 Shank Wheel Brushes, crimped wire**

**2A Steel wire 0.30 mm**

**2B Brass wire 0.20 mm**

**2c Stainless Steel wire 0.30 mm**

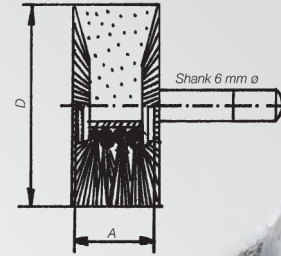

**3 Shank Cup Brushes, crimped wire**

**3A Steel wire 0.30 / 0.35 mm**

**3B Brass wire 0.20 / 0.25 mm**

**3c Stainless Steel wire 0.30 / 0.35 mm**



**4 Wheel and Cup Brushes, knotted**

**4a Steel wire 0.50 mm**

**4b Stainless Steel wire 0.50 mm**

\* Cup Brush with shank, knotted



D Ø (mm)	B Bore / G Thread	RPM (1/min)	1A Art. No	1B Art. No	1c Art. No
60	16	12000	606026330	606026130	606024230
60	M14	12000	606016330	606016130	606014230
75	16	10000	607526330	607526130	607524230
75	M14	10000	607516330	607516130	607514230
80	22.2	10000	608003330	608003130	608004230
80	M14	10000	608013330	608013130	608014230
100	22.2	8500	610003330	610003130	610004230
100	M14	8500	610013330	610013130	610014230
125	22.2	6500	612503330	612503130	612503230
125	M14	6500	612513330	612513130	612513230
150	22.2	4500	615003330	615003130	615003230
150	M14	4500	615013335	615013130	615013230

D Ø (mm)	A (mm)	RPM (1/min)	2A Art.No.	2B Art.No.	2c Art.No.
20	6	20000	—	802006120	—
30	7 - 8	20000	803008330	803008120	803008230
40	10 - 12	18000	804011330	804011120	804011230
50	8 - 10	4500 HW	805008330	—	—
50	10 - 12	15000	805011330	805011120	805011230
50	16 - 18	15000	805017330	805017120	805017230
60	10 - 12	15000	806012330	806012120	806012230
60	16 - 18	15000	806018330	806018120	806018230
70	10 - 12	15000	807012330	807012120	807012230
70	17 - 19	15000	807018330	807018120	807018230
75	8 - 10	4500 HW	807510330	807510120	807510230
80	12 - 14	15000	808012330	808012120	808012230
80	18 - 20	15000	808019330	808019120	808019230
100	8 - 10	10000	810010335	810010130	810010230

			3A	3B	3c
50	4500 HW		605071330	605071120	605071230
50	4500		605071335	605171125	605071235
70	4500		607071330	607071120	605071230
75	4500 HW		607571335	607571125	605071235

D Ø (mm)	Knots	Rows	RPM (1/min)	4A	4B
75	16	1	20000	107571350	107571250
90	16	1	20000	109071350	109071250
70	16	2	20000	107081350	107081250
55*	16	1	6000	305571350	305571250

## 1 Polishing Pads

flannel (molleton) fabric - 45 layers with std. bore

150 mm Art.No. **PP-150-45**    200 mm Art.No. **PP-200-45**    250 mm Art.No. **PP-250-45**

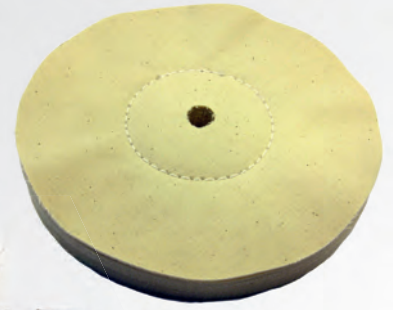

## 2 Tube Brushes

2A Steel wire 0.35 mm straight

2B Steel wire 0.30 mm crimped

2C Brass wire 0.30 mm crimped



## 3 Hand Wire Brushes

suitable for derusting, removal of paint residues and cleaning, 4-rows

straight steel wire

Art.No. **001.143523**

crimped brass wire

Art.No. **002.243523**

straight stainless steel (inox)

Art.No. **004.1431230**



## 4 Spark Plug Brushes

for automotive workshops and fine machining, 3-rows

crimped brass wire **0.15 mm** Art.No. **13115**

crimped brass wire **0.20 mm** Art.No. **13120**

crimped brass wire **0.25 mm** Art.No. **13125**



## 5 File Cards

for cleaning wood and metal files, fill length 100 mm

**200 x 25 mm** Art.No. **280225**

**200 x 40 mm** Art.No. **280240**

**200 x 50 mm** Art.No. **280250**



## 6 Steel Wire Brooms

for workshops with concrete floors, 6-rows

size **300 x 70 mm**, fill height **70 mm** Art.No. **181.165070**



## 7 Street Brooms

wooden body, with straight red PVC bristles



## 8 Floor Brooms

wooden body, with straight black PVC bristles



## 9 Floor Squeegees

with metal support

∅ (mm)	2A Art. No.	2B Art. No.	2C Art. No.
20	090203	09020330	09020130
22	090223	09022330	09022130
25	090253	09025330	09025130
30	090303	09030330	09030130
32	090323	09032330	09032130
38	090383	09038330	09038130
44	090443	09044330	09044130
50	090503	09050330	09050130
57	090573	09057330	09057130
63	090633	09063330	09063130
69	090693	09069330	09069130
75	090753	09075330	09075130
82	090823	09082330	09082130
94	090943	09094330	09094130
101	091013	09101330	09101130

Size (cm)	Rows	7 Art.No.	Size (cm)	8 Art.No.	Size (cm)	9 Art.No.
29	5	10316	30	23010	35	36235
40	6	10916	40	24010	45	36245
50	6	12516	50	25010	60	36260
60	6	13016	60	26010		



**VBW**   
Die Welt der Zangen

**1 Heavy-Duty End Cutting Nippers**  
polished head



**2 Tower Pincers**  
black laquered, polished head



**3 Combination Pliers**  
polished head



**4 Side Cutters**  
polished head



- N** without handle coating
- P** dip coated handles
- 2K** ergonomic 2-component handles

**5 Long Nose Pliers**  
telephone engineer's pliers  
polished head



**6 45° Long Nose Pliers**  
polished head



**7 Wire Strippers**  
polished head



**8 Waterpump Pliers**  
8A red laquered, polished



8B black laquered



Length (mm)	Handle Design	1 Art.No.	3 Art.No.	5 Art.No.	7 Art.No.
160	P	584 605	160 2K 545 305	140 2K 524 202	160 2K 543 205
200	P	584 615	180 2K 545 310	160 2K 524 203	160 P 543 305
			200 2K 545 315	200 2K 524 205	
			160 P 545 605	140 P 524 602	8A
224	N	510 005	180 P 545 610	160 P 524 603	175 N 966 005
250	N	510 010	200 P 545 615	200 P 524 605	240 N 966 010
280	N	510 015			300 N 966 015
315	N	510 020	4	6	8B
224	P	510 105	140 2K 587 215	160 2K 526 005	177 P 966 165
250	P	510 110	160 2K 587 220	200 2K 526 010	242 P 966 166
280	P	510 115	180 2K 587 225	160 P 526 600	302 P 966 167
315	P	510 120	125 P 587 605	200 P 526 605	
			140 P 587 610		
			160 P 587 215		
			180 P 587 220		



**9 Plier Sets 3 pcs.**  
 1x side cutting plier (160 mm),  
 1x combination plier (180 mm),  
 1x long nose plier (200 mm)

**2K** Art.No. **800 025**  
**P** Art.No. **800 045**



**10 Plier Sets 3 pcs.**  
 1x side cutting plier (160 mm),  
 1x combination plier (180 mm),  
 1x waterpump plier (250 mm)

**P** Art.No. **800 050**



**11 VDE Plier Set 3 pcs.**  
 chrome plated haed  
 1x side cutting plier (160 mm),  
 1x combination plier (180 mm),  
 1x waterpump plier (250 mm)

**2K** Art.No. **800 005**

**Circlip Pliers for Outside Circlips** polished head

**12** bent jaws 90°



**13** with straight jaws



**Circlip Pliers for Inside Circlips** polished head

**14** bent jaws 90°



**15** with straight jaws



**16 WAGGONIT® Cutters**

bolt cutters, red lacquered - drop forged steel - cutting force up to 48 HRc



Type	Length (mm)	Handle Design	<b>12</b> Art.No.
A01	<b>125</b>	<b>P</b>	534 105
A11	<b>125</b>	<b>P</b>	534 110
A21	<b>170</b>	<b>P</b>	534 115
A31	<b>200</b>	<b>P</b>	534 120
A41	<b>290</b>	<b>P</b>	534 125

**13**

A0	<b>140</b>	<b>P</b>	533 640
A1	<b>140</b>	<b>P</b>	533 645
A2	<b>180</b>	<b>P</b>	533 650
A3	<b>225</b>	<b>P</b>	533 655
A4	<b>325</b>	<b>P</b>	533 660

**14**

J01	<b>125</b>	<b>P</b>	532 105
J11	<b>125</b>	<b>P</b>	532 110
J21	<b>170</b>	<b>P</b>	532 115
J31	<b>200</b>	<b>P</b>	532 120
J41	<b>290</b>	<b>P</b>	532 125

**15**

J0	<b>140</b>	<b>P</b>	531 600
J1	<b>140</b>	<b>P</b>	531 605
J2	<b>180</b>	<b>P</b>	531 610
J3	<b>225</b>	<b>P</b>	531 615
J4	<b>320</b>	<b>P</b>	531 620

**16**

<b>460</b>	<b>P</b>	980 005
<b>610</b>	<b>P</b>	980 010
<b>760</b>	<b>P</b>	980 015
<b>910</b>	<b>P</b>	980 020





**1 Grips with Wire Cutters**  
with drop-forged chrome vanadium steel jaws; used for round and flat materials



**2 Prisma Grips**  
with drop-forged chrome vanadium steel jaws; used for round and flat materials



**3 Parallel Plus Grips**  
with drop-forged chrome vanadium steel jaws; used for round and flat materials

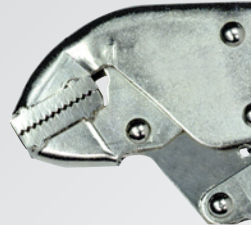

**4 Parallel Grips**  
with drop-forged chrome vanadium steel jaws; used for flat and shaped materials



**5 Grips with Straight Drop-forged Jaws**  
of chrome vanadium steel; used for flat materials



**6 Ideal Grips**  
with drop-forged chrome vanadium steel jaws; used for flat, round, shaped and square materials



**7 Welding Grips with Jaws**  
of chrome vanadium steel



**8 Grips for Tubes with Jaws**  
of chrome vanadium steel



**9 C-clamp Grips with Wire Cutters**  
with drop-forged chrome vanadium steel jaws  
**10 C-clamp Grips with Wire Cutters**  
with drop-forged chrome vanadium steel jaws  
**11 C-clamp Grips with Wire Cutters**  
with drop-forged chrome vanadium steel jaws

**12 Parallel C-clamp Grips**  
with movable jaws

**13 Parallel C-clamp Grips**  
with movable jaws



Capacity (mm)	Length (mm)	Art.No.	1	2	5	8	11							
22	110	0100-0104	30	180	0110-0118	10-90	280	0320-0320	350	500	0340-0344			
30	140	0100-0105	35	250	0110-0125			9			12			
35	180	0100-0107	50	300	0110-0130			6	50	175	0340-0340	40	175	0350-0350
50	250	0100-0110			3	35	180	0250-0251	90	280	0340-0341	90	280	0350-0351
65	300	0100-0112			4	50	250	0250-0252			10			13
					7	220	460	0340-0342	225	460	0350-0352			
					4	320	600	0340-0343	295	600	0350-0353			
					60	280	0300-0300							

**1 ODÜR - FIT Pliers**

with isolating handle made of high quality plastic  
 ... 12 individually boxes packed in one display carton packing:  
 300 pcs in wooden case or 720 pcs in strong export carton

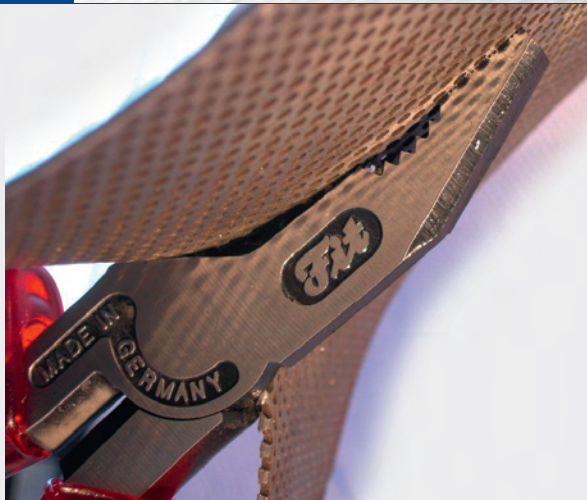

**2 Adjustable Pipe Grip Wrenches**

straight version - made in Austria



**3 Adjustable Pipe Grip Wrenches**

angled version - made in Austria



**4 Adjustable Pipe Grip Wrenches with Nut**

made in Czech Republic



**5 Adjustable Wrenches with Scales**

chrome plated, made of chrome vanadium steel



**6 Adjustable Wrenches with Scales**

phosphated - with polished head



**7 Adjustable Wrenches with Scales**

chrome plated - with polished head



1				5			7		
Length (mm)	Length (inch)	Weight (g)	Art.No.	Length (mm)	Head Size (mm)	Art.No.	Length (mm)	Head Size (mm)	Art.No.
200	8	280	14/8"	150	19	9263458	115	13	390000482
			<b>2</b>	200	24	9263468	160	20	390000682
175	7	274	136/7	250	29	9263478	205	24	390000882
230	9	496	136/9	300	33	6265588	255	29	390001082
280	10.5	787	136/10.5			<b>6</b>	310	34	390001282
315	12	951	136/12	115	13	390000437	380	44	390001582
360	14	1562	136/14	160	20	390000637	460	53	390001882
			<b>3</b>	205	24	390000837			
175	7	256	236/7	255	29	390001037			
230	9	517	236/9	310	34	390001237			
305	12	923	236/12	380	44	390001537			
			<b>4</b>	460	53	390001837			
175		300	257/175						
240		460	257/240						
270		700	257/270						
300		850	257/300						

**1 Aviation Snips**

for short, straight and curved cuts edges with micro-serrations for slip-proof working

**1A right****1B left****1c no offset to blades-straight cuts**

...with a large radius in both left and right directions

**2 American Pattern Snips**

for straight cuts - only left cutting available

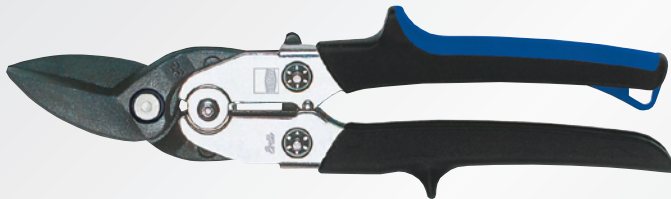
**2A with lacquered handles****2B with blue colour PVC coated handles w/o ill.****3 Shape Cutting Snips**

for short, straight and outline cuts, edges with micro-serrations for slip-proof working

**3A right****3B left****4 Shape and Straight Cutting Snips**

for long continuous, straight and curved cuts, edges with micro-serrations for slip-proof working

**4A right****4B left****5 Straight Cutting Snips**

for long continuous, straight cuts, edges with micro-serrations for slip-proof working

**5A right****5B left**

Length (mm) (inch)	Weight (g)	<b>1A</b> Art.No.	<b>1B</b> Art.No.	<b>1c</b> Art.No.
<b>240</b> 9 1/2	380	<b>D16-R</b>	<b>D16-L</b>	<b>D16-S</b>
		<b>2A</b>	<b>2B</b>	
<b>200</b> 8	240	<b>D146-200</b>	<b>D146-200/PVC</b>	
<b>250</b> 10	470	<b>D146-250</b>	<b>D146-250/PVC</b>	
<b>300</b> 12	630	<b>D146-300</b>	<b>D146-300/PVC</b>	
<b>350</b> 14	910	<b>D146-350</b>	<b>D146-350/PVC</b>	
		<b>3A</b>	<b>3B</b>	
<b>260</b> 10 1/4	480	<b>D27-R</b>	<b>D27-L</b>	
		<b>4A</b>	<b>4B</b>	
<b>260</b> 10 1/4	520	<b>D27A-R</b>	<b>D27A-L</b>	
		<b>5A</b>	<b>5B</b>	
<b>260</b> 10 1/4	520	<b>D27B-R</b>	<b>D27B-L</b>	

**1 Standard Tin Snips**

for short, straight and curved cuts

**1A right**

**1B left**

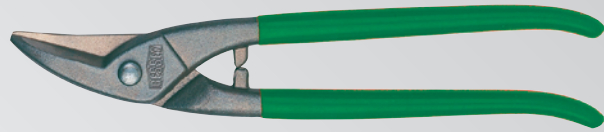

**2 Standard Tin Snips - Curved Blades**

especially for circular cuts - semi-circular edges

**2A right**

**2B left**



**3 Berlin Pattern Snips**

for straight cuts - only right cutting available with lacquered handles



**4 English Pattern Snips**

for straight cuts - only left cutting available with lacquered handles



**5 Hole Cutting Shears**

with yellow plastic coated handles

**5A right cutting**

**5B right cutting with spring**

**5C left cutting**

**5D left cutting with spring**



**6 Berlin Pattern Snips**

for straight cuts - only right cutting available with yellow plastic coated handles

**6A without spring**

**6B with spring**



	Length (mm) (inch)	Weight (g)	Art.No.	
			<b>1A</b>	<b>1B</b>
<b>250</b>	10	490	D107R-250	D107L-250
<b>275</b>	11	550	D107R-275	D107L-275
<b>300</b>	12	600	D107R-300	D107L-300
			<b>2A</b>	<b>2B</b>
<b>275</b>	11	510	D208R-275	D208L-275
			<b>3</b>	
<b>225</b>	9	440	D102-225	
<b>250</b>	10	480	D102-250	
<b>300</b>	12	720	D102-300	
			<b>4</b>	
<b>200</b>	8	280	D159-200	
<b>250</b>	10	480	D159-250	
<b>300</b>	12	630	D159-300	
<b>350</b>	14	830	D159-350	
			<b>5A</b>	<b>5B</b>
<b>225</b>	9	330	213000225	213010225
<b>250</b>	10	450	213000250	213010250
<b>275</b>	11	470	213000275	213010275
<b>300</b>	12	700	213000300	213010300
			<b>5c</b>	<b>5D</b>
<b>250</b>	10	450	213200250	213210250
<b>275</b>	11	470	213200275	213210275
<b>300</b>	12	700	213200300	213210300
			<b>6A</b>	<b>6B</b>
<b>250</b>	10	550	214000250	214010250
<b>275</b>	11	650	214000275	214010275

# FISKARS®

## 1 Power Gear Pruners

with handles made from FiberComp™, unique rotating handle, blades made from extra hard, corrosion resistant steel, non stick PTFE coating on upper blade



1A Bypass Pruner



1B Anvil Pruner

## 2 Smart Fit Pruners



**Bypass Pruner** multi-purpose with an adjustable cutting aperture, locking mechanism is accessible with one hand, comfortable Soft-Grip™ handles

## 3 Single Step Pruners

### 3A Snip - multi purpose

Pruner for multi cutting tasks like plastic, tube, rope or hose, not for cutting branches in garden, sturdy handles for a comfortable grip



3B Bypass Basic Pruner

sturdy handles for a comfortable grip, non stick PTFE coating on the upper blade, carbon steel blades



3c Anvil Basic Pruner

sturdy handles for a comfortable grip, non stick PTFE coating on the upper blade, anvil blade made from polyamide, carbon steel blades

## 4 Inspiration Pruners

in trendy white colour sturdy handles for a comfortable grip, non stick PTFE coating on the upper blade, carbon steel blades



4A Bypass Pruner



4B Anvil Pruner anvil blade made from polyamide,



	cutting capacity (cm)	length (mm)	weight (gr)	Art.No.
1A	26	207	272	111540
	20	200	192	111520
1B	20	192	192	111510
2	24	208	192	111610
3A	—	206	196	111270
3B	22	208	200	111260
3c	22	200	196	111250
4A	22	208	200	111265
4B	22	200	196	111255

**1 Power Gear Lopper**

with handles made from FiberComp™, SoftGrip™ covered handles, PowerGear™ mechanism makes cutting 3 times easier, upper blade made from high quality hardened steel, non stick PTFE coating on upper blade



**1A Bypass Lopper**



**1B Anvil Lopper**



**1c same a.m.** but anvil blade made from FiberComp™



**1d same a.m.** but anvil blade made from FiberComp™



**2 Single Step Lopper**

with handles made from lightweight durable polypropylene, blade material: hardened steel, friction reducing coating

**2A Bypass Lopper**

**2B Anvil Lopper**

anvil blade made of lightweight strong aluminium



**3 Power Lever Hedge Shear**

handles made from FiberComp™, PowerLever™ mechanism makes cutting 2,5 times easier, blades made from extra hard, corrosion resistant steel



**4 Single Step Hedge Shear**

comfortable and sturdy handles of glass fiber reinforced polypropylene, wavy profiled hardened steel blades with friction reducing coating



**5 Knives**

**5A Utility Knife** general purpose knife with plastic sheath with finger guard, blade made of stainless steel

**5B Hooked Crafting Knife / 5c Crafting Pocket Knife** handle made of plastic attached with a brass rivet, blade of stainless steel



	cutting capacity (cm)	length (mm)	weight (gr)	Art.No.
<b>1A</b>	50	570	690	112590
	38	545	550	112290
	38	460	490	112190
<b>1B</b>	50	686	1046	112580
<b>1c</b>	38	545	550	112280
<b>1d</b>	35	387	375	112170
<b>2A</b>	35	500	1050	112160
	40	816	1300	112460
<b>2B</b>	40	816	1340	112450
<b>3</b>		544	630	114750
<b>4</b>		580	840	114730
<b>5A</b>	218	70		125860
<b>5B</b>	170	50		125880
<b>5c</b>	170	50		125890

# FISKARS®



## 1 Universal Garden Scissors



for cutting flowers and plants, ergonomic handle, handles made from impact-resistant PBT, extra hard stainless steel blades

length 248 mm Art.No. **111050 - S94**

length 212 mm Art.No. **111040 - S90**

length 185 mm Art.No. **111030 - S92**



## 2 Floral Scissors



for cutting flowers and sprouts, extra hard stainless steel blades

### 2A Fiber Comp handles with SoftGrip

length 216 mm Art.No. **111020 - S60**



### 2B serrated lower blade for better control

length 192 mm Art.No. **111010 - S28**



### 2c sharp pointed blades for precise cutting

length 152 mm Art.No. **111000 - S23**

# JB BERGER Germany

## 3 Classic Lopping Shears

cutting head with anti-adhesive blades for clean cut, chrome plated, all screw joints are fixed with self locking nut, high-grade aluminium tubes and handles with hand guard

total length 450 mm Art.No. **4195**

total length 600 mm Art.No. **4200**

total length 750 mm Art.No. **4204**



## 4 Gardening Shears

forged metal body - chromium plated cutting head

total length 215 mm Art.No. **1760**

## 5 Gardening Shears

forged metal body - frost protective coating in handle area - ring lock

total length 210 mm Art.No. **1700**

## 6 Pruning Shears

forged metal body - frost protective coating in handle area - ring lock

total length 200 mm Art.No. **1580**

## 7 Sheep Shears

round spring, straight hot drop forged model

7A cutting length 155 mm, total length 300 mm Art.No. **2712**

7B cutting length 140 mm, total length 275 mm Art.No. **2711**

### 1 Tube Cutters

precision machining provides quickest and smoothest action, extremely robust and compact - easy to use

#### 1A 32 mm

for copper tubes Art.No. **63170**  
for stainless steel - inox tubes Art.No. **63094**

#### 1B 42 mm

for copper tubes Art.No. **63119**  
for stainless steel - inox tubes Art.No. **63121**



### 2 Pipe Cutters for Steel Tubes

with one cutting wheel and two guide rollers

#### 2A Size 1/8" - 2"

for steel pipes Art.No. **00100200**  
for stainless steel pipes (inox) Art.No. **00100200VA**

#### 2B Size 1.1/4" - 4"

for steel pipes Art.No. **00100400**  
for stainless steel pipes (inox) Art.No. **00100400VA**



### 3 Spare Wheels

suitable for 00100200 Art.No. **00100205**  
suitable for 00100200VA Art.No. **00100218**  
suitable for 00100400 Art.No. **00100405**  
suitable for 00100400VA Art.No. **00100418**



### 4 Sanitary Lever Wrenches

forged chromium-vanadium steel -  
works in both directions - for nuts up to SW 30 mm  
total length 235 mm Art.No. **00452400**



### 5 Hydraulic Pipe Bending Tools

the innovative 2-velo valve system  
enables automatically fast pre-loading together  
with a soft bending without any need to change pistons  
pipe dia 1/4" - 2" - load cap. up to 10 tons Art.No. **60015**  
pipe dia 1/4" - 3" - load cap. up to 13 tons Art.No. **60016**







## 1 Crimping Hand Tool – ratchet type

Ergonomic soft-handles with slip-off protection, precise guide tracking of the tool ensures a high quality professional application. Suitable for red/blue/yellow DIN cable lugs, pin cable lugs, tabs and receptacles, circular connectors, butt and parallel connectors

Art.No. **CK 90-44**

Crimping Range red 0.5 - 1.0 / blue 1.5 - 2.5 / yellow 4.0 - 6.0 mm<sup>2</sup>

\*other crimp options available on request



## 2 Crimping Hand Tool – ratchet type sets

Ergonomic soft-handles with slip-off protection, precise guide tracking of the tool ensures a high quality professional application, with exchangeable crimping die sets".

**2A** SET 44: red/blue/yellow cable lugs/pin cable lugs, tabs, receptacles, circular connectors, butt parallel connectors

Art.No. **CK 100 SET 44**

Crimping Range red 0.5 - 1.0 / blue 1.5 - 2.5 / yellow 4.0 - 6.0 mm<sup>2</sup>

**2B** SET 65: flat push-on receptacles and tabs without insulation

Art.No. **CK 100 SET 65**

Crimping Range 0.14 - 10.0 mm<sup>2</sup>

**2c** SET AE2: wire end ferrules with and without insulation sleeve

Art.No. **CK 100 SET AE21**

Crimping Range (mm<sup>2</sup>) 0.5 - 10.0 mm<sup>2</sup>

## 3 Hydraulic Punching Tools

Punches accurate slugs nearly free of burs, easy single handed using with small effort, straight handle, punching capacity steel plates up to max. 3 mm

**3A** Straight handle, punching force 80 kN, cross Ref. 50-600 Art.No. **LS8**

**3B** Angled handle, punching force 60 kN, cross Ref. 50-099 Art.No. **LS6**

### 3c Hydraulic Punching Tool Set

Consisting of: Edges and Matrix dia. 16.5 mm (M16), 20.5 mm (M20), 25.5 mm (M25), 32.5 mm (M32). Components: 3 Elastic Inserts, 1 Sleeve, 1 Adapter, 1 Rod, 1 Plastic Case with Insert,

Cross Ref. 50-608 Art.No. **LS8-SET**



3c



3A

3B



4A

## 4 Mechanical Crimping Tools

Indent Crimping for tubular cable lugs and connectors with revolving dies, PVC coated handles, with blue/yellow insulation

**4A** Indent Crimping

**4B** Hexagonal Crimping



4B

## 5 Mechanical Crimping Tools

Indent Crimping for cable end-sleeves, insulated PVC coated handles, with wire cutter



Type	Crimping Range (mm <sup>2</sup> )	Length (mm)	Art.No.
			<b>4A</b>
<b>K5</b>	6 - 50	600	<b>K5 EG</b>
<b>K6</b>	50 - 120	970	<b>K6 EG</b>
<b>K7</b>	120 - 240	975	<b>K7 EG</b>
<b>K07</b>	185 - 400	975	<b>K07 EG</b>
<b>K8</b>	35 - 95	970	<b>K8 EG</b>
			<b>4B</b>
<b>K05</b>	6 - 50	390	<b>K05 EG</b>
<b>K06</b>	10 - 120	650	<b>K06 EG</b>
<b>K09</b>	25 - 150	650	<b>K09 EG</b>
			<b>5</b>
<b>K3</b>	0.5 - 16	230	<b>PK3</b>

## 1 Mechanical Cable Cutters - hand operated

PVC coated handles with blue/yellow insulation, suitable for CU and AL cables - not suitable for cutting steel or steel wire

**K100**

Crimping Range Ø max. (mm)  
Length (mm)  
Art.No.

14  
280  
K100 EG

**K101/1**

26  
570  
K101/1 EG

**K101/2**

Crimping Range Ø max. (mm)  
Length (mm)  
Art.No.

38  
930  
K101/2 EG

**K130**

30  
570  
K130 EG

**K150**

50  
710  
K150 EG

**K103/1**

Crimping Range Ø max. (mm)  
Length (mm)  
Art.No.

60  
720  
SH 600

**K104/1**

100  
870  
SH 1000

## 2 Mechanical Cable Cutters - one hand operation

PVC coated handles with blue insulation, suitable for CU and AL Cables - not suitable for cutting steel or steel wire

**K106/1**

Crimping Range Ø max. (mm)  
Length (mm)  
Art.No.

32  
260  
SH 320

**K106/2**

52  
285  
SH 500



## 1 Crimping Tool Sets

hand-operated, with yellow chromated Cu-hexagonal crimping dies, in blue metal carrying case,

**1A PK130C KI C-compression Heads**  
rotating 180°, double piston pump, safety relief valve, 13 crimping dies, crimping range 10 - 400 mm<sup>2</sup>

Art.No. [SET PK130 KI](#)



**1B HP 60/22 Slim Crimping Heads**  
ideal for narrow crimping, 12 crimping dies, crimping range 10 - 300 mm<sup>2</sup>

Art.No. [SET HP60/22 KI](#)

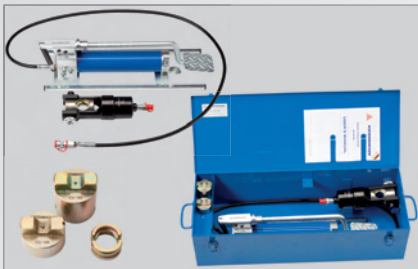

## 2 PK250 KI

foot-operated in blue metal transport case

Set consisting of: crimping head PK250, foot pump 700 bar with 2 m hose and coupling, with yellow chromated Cu-hexagonal crimping dies (14 pcs.)

Crimping Range 16 - 630 mm<sup>2</sup>

Art.No. [SET PK250 KI](#)

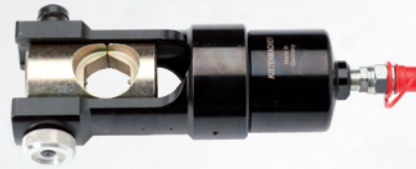

## 3 PK450 KI

foot-operated in blue metal transport case

Set consisting of: crimping head PK450, foot pump 700 bar with 2 m hose and coupling, with yellow chromated Cu-hexagonal crimping dies (11 pcs.)

Crimping Range 95 - 1000 mm<sup>2</sup>

Art.No. [SET PK450 KI](#)



## 4 Hydraulic Crimping Tool Sets

Battery powered in blue metal carrying case with yellow chromated Cu-hexagonal crimping dies and memory card

Set consisting of: spare battery, battery charger, software, USB data cable, incl. battery



### 4A APE 6-22 KI

Crimping Range 10 - 300 mm<sup>2</sup>  
with 12 crimping dies, battery tool

Art.No. [SET APE 6-22 KI](#)



### 4B APE 13C KI

Crimping Range 10 - 400 mm<sup>2</sup>  
with 13 crimping dies, battery tool

Art.No. [SET APE 13C KI](#)

## 1 Hydraulic Cable Cutters HKS

hand-operated with rotated cutting head 360°, complete with blue metal carrying case



### 45 KI

cuts armoured copper and aluminium cables, solid steel bars up to 16 mm

### 50 KI

cuts copper and aluminium cables

### 85 KI

Cutting Power  
Cutting Range max. (mm)  
Art.No.

70 kN

45

HS 45 KI

50kN

50

HS 50 KI

70kN

85

HS 85 KI

## 2 Hydraulic Cable Cutter Sets KS85 KI

foot-operated in blue metal transport case with rotated cutting head 180°, suitable for aluminium and copper cables

Set consisting of:

cutting head SK 85,  
foot pump 700 bar  
with 2 m hose and coupling

Cutting Power

70 kN

Cutting Range max. (mm)

85

Art.No.

SET KS 85 KI

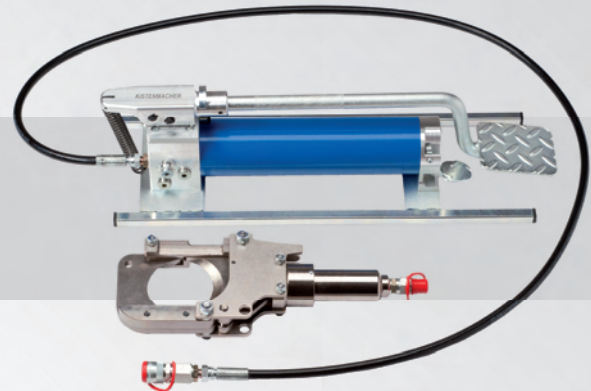

## 3 Hydraulic Cable Cutter Heads

black lacquered, with rotated cutting head 180°, double piston pump and automatic safety relief valve



### SK 45

suitable for **armoured copper** and aluminium cables up to 45 mm, solid steel bars up to 16 mm



### SK 50

suitable for aluminium and copper cables

Cutting Power  
Cutting Range max. (mm)  
Art.No.

70 kN

45

SK 45 KI

50 kN

50

SK 50 KI

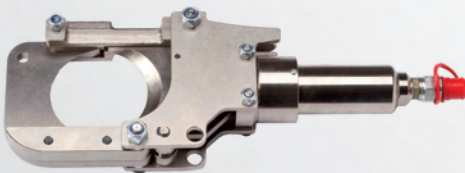

### SK 85

suitable for aluminium and copper cables

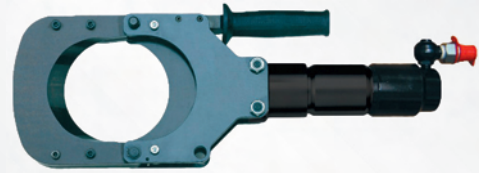

### SK 120

suitable for aluminium and copper cables

### SK 120ST

suitable for **armoured copper** cables

Cutting Power  
Cutting Range max. (mm)  
Art.No.

70 kN

85

SK 85 KI

100 kN

120

SK 120 KI

135 kN

120

SK 120ST KI

## 4 Hydraulic Cutting Tools SET ASE 85 KI

Battery Powered in blue metal carrying case with memory card

Set consisting of:

AKKU Tool ASE 85 KI, incl. battery,  
spare battery, battery charger,  
software, USB Data Cable

Cutting Range max. (mm)

85

Art.No.

SET ASE 85 KI



## Tile Cutting Machines

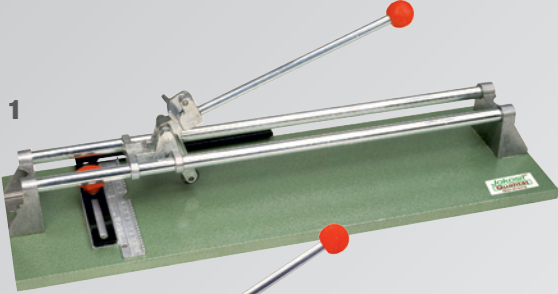

1



2

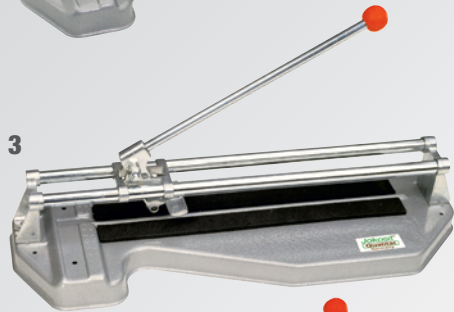

3

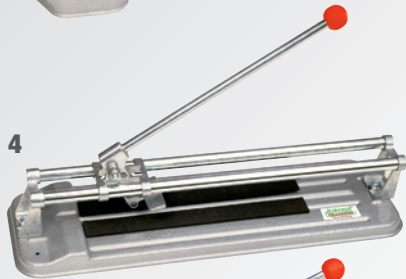

4

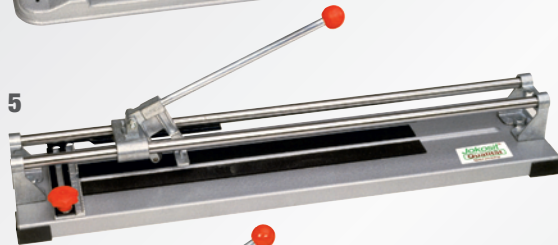

5

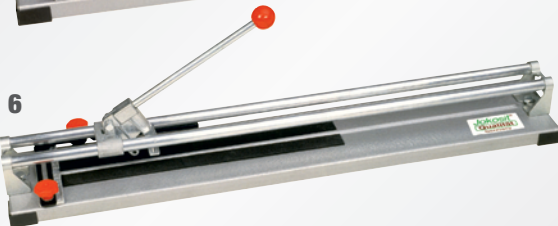

6



**7** with linear ball bearings, hardened and ground guide shaft, angle adjustment, precision design



8

9



10



11

	Cutting Length (mm)	Tile Thickness (mm)	Ø (mm)	Base Plate	Angle Adjustment	Linear Ball Bearings	Professional Design	Art.No.
<b>1</b>	470	15	22 x 6	wooden	X			110
<b>2</b>	330	15	15 x 6	strong steel	X			111
<b>3</b>	310	10	15 x 6	steel				113
<b>4</b>	300	10	15 x 6	steel				115
<b>5</b>	470	18	22 x 6	steel	X		X	153
	600	18	22 x 6	steel	X		X	154
<b>6</b>	800	18	22 x 6	steel	X		X	158
<b>7</b>	470	18	22 x 6	steel	X	X	X	163
	600	18	22 x 6	steel	X	X	X	164
<b>8</b>	800	18	22 x 6	steel	X	X		165
<b>9</b>	400	15	15 x 6	steel				166
<b>10</b>	300	10	15 x 6	steel				173
<b>11</b>	400	18	22 x 6	steel				190



**12** Carbide Cutting Wheels, Ground  
dia 22 x 6 mm Art.No. **053**



**13** Carbide Cutting Wheels, Ground  
dia 15 x 6 mm Art.No. **054**



**14** Tile Hole-cutter Drill Attachments  
carbide, drilling range 30 - 80 mm, fits all usual drills  
Art.No. **600**

**1 Soldering Iron for Plumbers**

with wooden handle

**1A Type No. 1 - Hammer Head**

**1B Type No. 4 - Taper Head**

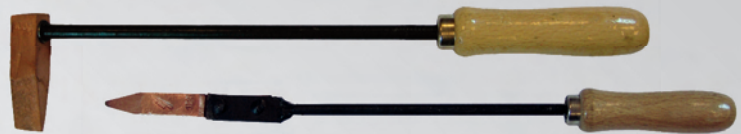

**2 Electric Soldering Irons**

with wooden handle, with 2 core cable (1.5 m) and euro plug (230 V), packed in coloured display cartons

**2A Lightweight model**

**2B Heavy duty model**



**3 STANNOL Soldering Irons**

with plastic handle, cable length approx. 1.5 m and safety plug (230 V), packed in individual cartons

**3A** for electronics soldering

**3B** for soldering in radio and telecommunication work

**3C** for use in electrical installation and work involving fine wires and metal sheets

**3D** for metal sheets soldering and general workshop operation

**3E** for coarse soldering work in handicraft

**3F** for workshop and factory seam soldering on fine metal sheets

**3G** for workshop and factory seam soldering on metal sheets up to 1.0 mm thickness



**4 STANNOL Soldering Guns**

protection class II - double insulated, ready for soldering within 5 sec. (230 V)

**4A** black colour - blister packing

**4B** blue colour - blister packing

**4C** black colour - blister packing

**5 STANNOL Soldering Stations**

primary voltage: 230 V / 50 - 60 Hz

**5a INDUSTA 300**

secondary voltage: 12 V, regulation range: approx. 200 - 450°C infinite, for all electronic soldering tasks, for production and repair



**5b INDUSTA 300D**

soldering station with a digital temperature display, control range: 200 - 450°C (+/- 5 %), infinite adjustable, functiondisplay 3 digit display



**5c MPL 4010**

for industrial applications, secondary voltage 24 V, temp. range: 150 - 450°C, functiondisplay with 3 LED digit, electronic temperature controlled with stand-by function, setting to constant temperature, simple operation with a membrane keyboard



Art.No.	Weight (g)	Art.No.	Watt	Tip Temp. Approx. (°C)
<b>1</b> 1/100	100	<b>2A</b> 099/2D	40	
1/125	125	100/2D	50	
1/150	150	101/2D	60	
1/175	175	120/2D	75	
1/200	200	123/2D	80	
1/225	225	121/2D	100	
1/250	250	122/2D	125	
1/300	300	130/2D	150	
1/350	350	132/2D	200	
1/400	400			
1/500	500	<b>2B</b> 151/2D	250	
1/600	600	152/2D	300	
1/700	700	154/2D	400	
1/800	800	156/2D	500	
1/900	900			
1/1000	1000			
		<b>3A</b> 750100	15	370
		<b>3B</b> 750300	30	410
		<b>3C</b> 750600	60	460
		<b>3D</b> 750800	80	480
		<b>3E</b> 751000	100	500
		<b>3F</b> 751500	150	510
		<b>3G</b> 752000	200	530
		<b>4A</b> 206430-W90	60	
		<b>4B</b> 206460-EP75	75	
		<b>4C</b> 206786 -EP100	100	
		<b>5A</b> 760000	30	
		<b>5B</b> 760010	40	
		<b>5C</b> 765000	80	



**1 Brazing Powder "R4"**  
for brazing copper, brass, nickel-silver, steel and cast iron - EN 1045-FH20



**2 Welding Powder "R8"**  
for welding copper and brass - welding joint can be filled - EN 1045-FH20



**3 Aluminium Welding Powder "ALU3"**  
for welding thick aluminium sheets



**4 Soldering Paste (Grease)**  
for soldering tin-plate, leaded shett and for tinning copper and brass DIN 29454-1 3.1.1.C not suitable for electrical engineering and electronics.



**5 Hard Solder Paste**  
for hard soldering of copper, copper base alloys and steel as well as welding of brass - DIN EN 1044 FH 21



**6 Soldering Paste - Silver Solder**  
fluxing paste for brazing brass (fluxing paste)



**7 Soldering Liquid**  
flux for soldering iron, steel, copper and brass

	1		2		3		4		5	6		7	
	Art.No.	Art.No.	Art.No.	Art.No.	Art.No.	Art.No.	Art.No.	Art.No.	Art.No.	Art.No.	Art.No.	Art.No.	
	Felder	Stannol	Stannol	Felder	Stannol	Felder	Stannol	Felder	Felder	Felder	Stannol	Felder	Stannol
50 g	-	-	-	-	-	-	-	24310035	174071	-	-	-	-
100 g	-	-	-	-	-	-	-	24310050	174057	-	-	-	-
250 g	26200055	142030	143034	26400055	121036	24310055	174033	26250055	26100050	144038	-	-	-
500 g	26200060	142028	143022	-	-	-	-	26250060	26100060	-	-	-	-
500 ml	-	-	-	-	-	-	-	-	-	-	-	24220061	114018

**1 Soldering Wire - 2510 - HS10 - SP**

for soldering in the areas of electrical engineering and electronic as well as for electrical assembly and suitable for motor industry

- 1A Alloy - S-PB70Sn30 on spools of 227 g
- 1B Alloy - S-PB70Sn30 on spools of 454 g
- 1C Alloy - S-PB60Sn40 on spools of 100 g
- 1D Alloy - S-PB60Sn40 on spools of 250 g
- 1E Alloy - S-PB60Sn40 on spools of 500 g



**2 Soldering Wire - S321- RA**

for soldering onto metals, tins, brass, cans, batteries, not suitable for soldering involving electrical engineering and electronic applications

- 2A Alloy - S-PB70Sn30 on spools of 227 g
- 2B Alloy - S-PB70Sn30 on spools of 454 g
- 2C Alloy - S-PB60Sn40 on spools of 100 g
- 2D Alloy - S-PB60Sn40 on spools of 227 g
- 2E Alloy - S-PB60Sn40 on spools of 454 g



**3 Soft Soldering Rods - Triangular Sticks**

packed in cartons of 25 kg

- (30/70/H3) - Export Alloy - L-PbSn15Sb Art.No. 1215012092
- (40/60/H4) - Export Alloy - L-Pb78Sn20Sb2 Art.No. 1221012094
- (50/50/H6) - Export Alloy - L-Pb70Sn30 Art.No. 1231012095
- standard quality Alloy - S-Pb70Sn30 Art.No. 12310120
- standard quality Alloy - S-Pb60Sn40 Art.No. 12410122
- standard quality Alloy - S-Pb50Sn50Sb Art.No. 12510120



**4 Brass Welding Rods**

in length of 1 mtr., packed in bundles of 10 kg, each bundle packed in plastic foil, 10 bundles per case

- 4A SMS 60 - L-CuZn40 - **hard type**
- 4B SMS 63 - CuZn37 - **flexible type**

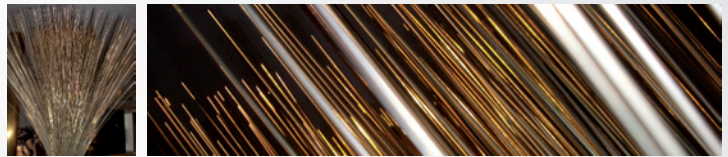

**5 Aluminium Welding Sticks**

HILCO Aluminium Si5, Welding Sticks E 4043-aluminium, packed in alu cans of 2.0 kg size 3.2 x 350 mm

Art.No. 66517



**6 Iron Stick Electrodes**

HILCO Nickel Iron Stick Electrodes, ENiFe-Ci, packed in packs of 1.0 kg size 3.2 x 350 mm

Art.No. 70403

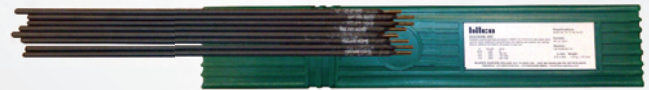

Ø (mm)	1A		1B		1C		1D		1E	
	Art.No.	Felder	Art.No.	Felder	Art.No.	Felder	Art.No.	Felder	Art.No.	Felder
1.0	15321017	15321027	15401010	477647	15401017	477650	15401027	477651		
1.5	15321517	15321527	15401510	-	15401517	-	15401527	-		
2.0	15322017	15322027	15402010	478934	15402017	478857	15402027	478854		
3.0	15323017	15323027	15403010	479442	15403017	-	15403027	479450		

Ø (mm)	2A		2B		2C		2D		2E		Ø (mm)	4A Art.No. Pym	4B Art.No. Pym
	Art.No.	Felder	Art.No.	Felder	Art.No.	Felder	Art.No.	Felder	Art.No.	Felder			
1.0	-	-	-	-	18401010	506943	18401020	506947	18401030	506946	2.0	756300020	MS63/2
1.2	18321217	501028	18321227	-	-	-	-	-	-	-	2.5	756300025	MS63/2,5
1.5	18321517	501029	18321527	18401510	507973	18401520	507970	-	-	-	3.0	756300030	MS63/3
1.8	18321817	-	18321827	-	-	-	-	-	-	-	4.0	756300040	MS63/4
2.0	18322017	501688	18322027	18402010	508521	18402020	508480	18402030	508454				
3.0	-	-	-	-	-	-	18403020	509082	18403030	509056			



# STEINEL®

## Hot Melt Glue Guns



### 1 GLUEFIX

small hot-melt glue applicator in a modern design for craft work and decorating  
high melting capacity



### 2 GLUEMATIC 3002

attractively priced, electronically controlled hot-melt glue applicator with high melting capacity for DIY and professional users  
includes 3 x ULTRA Power sticks

### 3 Glue Gun Set GLUEMATIC 3002

gluing and crafting set complete with 200 g glue sticks  
packed in attractive plastic case



### 4 GLUEMATIC 5000

electronically controlled hot-melt glue applicator with a very high melting capacity for cordless gluing, including long and short nozzle and 5 x ULTRA Power sticks

### 5 Glue Gun Set GLUEMATIC 5000

gluing and crafting set complete with 200 g glue sticks replaceable spare nozzle  
packed in attractive plastic case

### 6 Glue Sticks suitable for a.m. models

dia 11 mm, length 250 mm, 200 g per pack - 8 pcs per pack



### 7 Cordless Hot-Melt Glue Gun Neo1 & Neo2

cordless operation with rechargeable lithium-ion battery, 3,6 V – quick start within 15 sec. – new way of gluing without dripping – continues working run time up to 30 minutes; automatic switch off – including Micro-USB-charging adapter.

### 8 Glue Sticks Neo

suitable for different materials like paper, wood, glass, felt and many more, dia 7 mm, length 150 mm

	Art.No.	Output (Watt)	Melt Temp. (°C)	Voltage	Plug		Art.No.	colour
1	333911	175	200	100 - 240	2-pin	6	042035	transparent colour, ULTRA POWER
2	333317	200	206	100 - 240	2-pin		048310	transparent colour, CRISTAL
	330118	200	206	100 - 240	3-pin (BS standart, 13A)		048211	black colour
3	333393	200	206	100 - 240	2-pin		048112	white colour
4	332716	500	210 - 220	220 - 240	2-pin		047818	wood application
5	332754	500	210 - 220	230 - 240	2-pin	8		
7	334109 (Neo 1: 155 gr. weight)		170	110 - 240	2-pin (charger)		006624	transparent (cristal) 96 g
	334208 (Neo 2: 275 gr. weight)		170	110 - 240	2-pin (charger)		006594	transparent (cristal) 240 g

# STEINEL®

## Hot Air Guns

- 1 HL 1400 S**  
Promotion Type - starter model
- 2 HL 1610 S**  
with two heating and airflow stages, includes thermostat and thermal cut-out
- 3 HL 1810 S**  
with three heating and airflow stages, includes thermostat and thermal cut-out, cold-air stage for rapid cooling
- 4 HL 1910 E**  
electronically controlled hot air gun, with temperature control and cool air stage, includes thermostat and thermal cut-out, cold-air stage for rapid cooling
- 5 HL 2010 E**  
with LCD display, microprocessor controlled hot air gun with temperature control and cool air stage, includes thermostat and thermal cut-out
- 6 HG 2310 LCD**  
Professional Series  
electronically controlled hot air gun with continuously adjustable air flow and temperature control, overheating protection by thermostat and thermal fuse, LCD display mode in 10°C steps



## Accessories for Electronic and Fixed-stage Hot Air Tools

- 7 Reduction nozzle 9mm** focused source of hot air for desoldering and welding PVC
- 8 Window nozzle 75 mm** deflects to prevent panes of glass etc. from overheating
- 9 Surface nozzle 75 mm** spreads air over wider area for drying, paint stripping etc.
- 10 Reflector nozzle** for soldering pipes and fitting shrink-fit sleeves
- 11 Shrink tubing** for shrinking onto cable terminals, breaks or looms

- Art.No. **070618**
- Art.No. **070410**
- Art.No. **070212**
- Art.No. **070519**
- A** Art.No. **071318**
- B** Art.No. **071417**

range 1.6 – 4.8 mm dia.  
range 4.8 – 9.5 mm dia.

Art.No.	Art.No.	Output (Watt)	Melt Temp. (°C)	Voltage	Airflow Rate	Temperature Setting
2-pin-plug	BS standard*					
<b>1</b> 345914		1400	300/500	230 - 240	in 2 steps	2-stage
<b>2</b> 348014	348021	1600	300/500	230 - 240	in 2 steps	2-stage
<b>3</b> 348113	348106	1800	50/400/600	230 - 240	in 3 steps	3-stage
<b>4</b> 348410	348427	2000	50 - 600	230 - 240	in 3 steps	9 steps
<b>5</b> 348212		2000	50 - 630	230 - 240	in 3 steps	in 10°C steps
<b>6</b> 348311	348328	2300	50 - 650	230 - 240	in 2 steps	

\*with fused 3-pin plug (13A) – 220V



## 1 Hand Tackers

### 1A Tacker J-01A

for standard jobs made of ABS plastic material

### 1B Tacker J-02AL

for standard jobs made of ABS plastic material

### 1c Tacker J-16EADHG

for universal application, housing made of high-tech plastic

## 2 Hand Tackers - Professional

for universal application

### 2A Tacker J-09XX

housing made of metal (zinc diecast)

### 2B Tacker J-19EADHG

housing made of metal (zinc diecast)

## 3 Hammer Tackers

Rapid strike hammers for large areas

## 4 Electric Tackers

### 4a Tacker J-102DA

for standard jobs - with handle safety lock release for unintentional firing and staple inspection window  
electronic impact power adjuster - distance holder

### 4b Tacker J-155A

with automatic, electronic multistroke system

## 5 Cordless Tackers J-214EA

for universal application - with 2 storage batteries 3,6 V and charger - packed in DIY case

## 6 Airtackers J- 316A

for professional users - upholstery or heavy-duty panelling work, made of light alloy housing, muffler and long nozzle for accurate stapeling

supplied in carrying case - working pressure 4 - 7 bar with safety lock release

Art.No.	Staple Type	max. Staple Length (mm)	Art.No.	Staple Type	max. Staple Length (mm)	Art.No.	Staple Type	max. Staple Length (mm)	Art.No.	Staple Type	max. Staple Length (mm)
1A 030-0417	A	8	2A 030-0408	A/B/H/D/F/G	8	3 030-0371	H	6	5 031-0351	A/E	14
1B 030-0416	A/L	14	2B 030-0386	A/H/D/G/E	14	030-0372	G	10	6 032-0033	A	16
1c 030-0390	A/H/D/G/E	14				4A 031-0354	A/D	14			
						4B 031-0298	A/C/D/E	18			

**1 Fine Wire Staples - Type 53**

crown 11.3 mm

**1A** transparent packing **2000 pcs**

**1B** economy carton packing **5000 pcs**

**1c** transparent packing **1000 pcs**

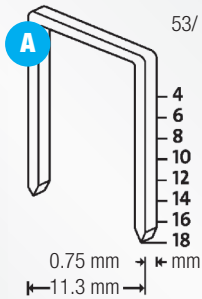

**2 Fine Wire Staples - Type 37**

crown 10.6 mm

**2A** transparent packing **2000 pcs**

**2B** economy carton packing **5000 pcs**

**2c** transparent packing **1000 pcs**

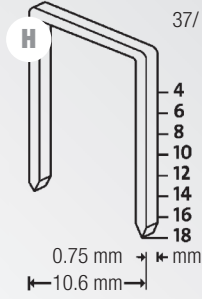

**3 Fine Wire Staples - Type 11**

crown 10.6 mm

**3A** economy carton packing **5000 pcs**

**3B** transparent packing **600 pcs**

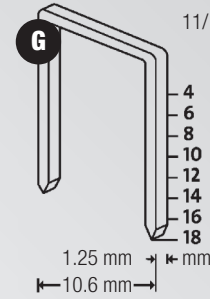

**4 Airtackers 1M-A16-S30**

Art.No. **1M-A16-S30**

for professional users - upholstery or heavy-duty panelling work, made of light alloy housing, muffler and long nozzle for accurate stapeling, supplied in handy carton box

for Staples Type A from 4 - 16 mm



**5 Staples Type A - suitable for Airtacker 1M-A16-S30**

made of galvanized steel, carton packing

**crown 12.90 mm; wire size: 0.65 x 0.95 mm**

**5A** 10.000 pcs

**5B** 8.000 pcs

**5C** 6.000 pcs

**5D** 4.000 pcs

**6 Carton Staplers - KTB19H (manual)**

Art.No. **048112**

for professional user, for Staples Type B from 16 - 19 mm for closing of corrugated paperboards in the packing industry



**7 Staples Type B- suitable for Carton Stapler KTB19H**

**crown 34.75 mm; wire size: 0.92 x 2.30 mm**

carton packing 10.000 pcs

**7A** staple length 16 mm Art.No. **B16CLF**

**7B** staple length 19 mm Art.No. **B19CLF**

Staple Type/ Length (mm)	Art.No.	Staple Type/ Length (mm)	Art.No.	Staple Type/ Length (mm)	Art.No.	Staple Length (mm)	Art.No.
<b>1A A 53/4</b>	042-0354	<b>2A H 37/4</b>	042-0368	<b>3A G 11/6</b>	042-0527	<b>5A 4</b>	A04CNK
<b>A 53/6</b>	042-0355	<b>H 37/6</b>	042-0369	<b>G 11/8</b>	042-0528	<b>6</b>	A06CNK
<b>A 53/8 super</b>	042-0356	<b>H 37/8</b>	042-0370	<b>G 11/10</b>	042-0529	<b>8</b>	A08CNK
<b>1B A 53/6</b>	042-0516	<b>2B H 37/6</b>	042-0535	<b>3B G 11/12</b>	042-0387	<b>5B 10</b>	A10CNK
<b>A 53/8 super</b>	042-0517	<b>H 37/8</b>	042-0536	<b>G 11/14</b>	042-0388	<b>5c 12</b>	A12CNK
<b>A 53/10 super</b>	042-0518	<b>H 37/10</b>	042-05378			<b>14</b>	A14CNK
<b>A 53/14 super</b>	042-0520	<b>2c H 37/12</b>	042-0372			<b>5D 16</b>	A16CNK
<b>1c A 53/18 super</b>	042-0360	<b>H 37/14</b>	042-0373				



### 1 Combination Spanners - Type 350(230)

chrome vanadium steel, chrome plated

### 2 Double Ended Open Jaw Spanners

chrome vanadium steel, chrome plated

2A Type 200 (690)

2B Type 250 (691)- short pattern

### 3 Double Ended Ring Spanners

chrome vanadium steel, chrome plated

3A Type 100 (290) - deep offset

3B Type 150 (291)- short pattern offset

### 4 Slogging Open Jaw Wrenches

special drop forged steel

### 5 Slogging Ring Wrenches

special drop forged steel

Size (mm)	4 Art.No.	5 Art.No.
22		2702207
24	6702407	2702407
27	6702707	2702707
30	6703007	2703007
32	6703207	2703207
36	6703607	2703607
41	6704107	2704107
46	6704607	2704607
50	6705007	2705007
55	6705507	2705507
60	6706007	2706007
65	6706507	2706507
70	6707007	2707007
75	6707507	2707507
80	6708007	2708007
85	6708507	2708507
90	6709007	2709007
95	6709507	2709507
100	6710007	2710007
105	6710507	2710507
110	6711007	2711007
115	6711507	2711507
120	6712007	2712007
125	6712507	2712507
130	6713007	2713007
135		2713507
140	6714007	2714007
145	6714507	2714507
150	6715007	2715007
155	6715507	2715507
160	6716007	2716007
165	6716507	2716507
170	6717007	2717007
175	6717507	2717507
180	6718007	2718007

Size (mm)	1 Art.No.	Size (mm)	2A Art.No.	3A Art.No.	2A Art.No.	3A Art.No.	Size (mm)	2B Art.No.
6	2300603	5.5 x 7	6905573		18 x 21	6918213 2918213	6 x 7	69106073
7	2300703	6 x 7	6906073 2906073		19 x 22	6919223 2919223	8 x 9	69108093
8	2300803	7 x 8	6907083 2907083		19 x 24	6919243 2919243	10 x 11	69110113
9	2300903	7 x 9	6907093		20 x 22	6920223 2920223	12 x 13	69112133
10	2301003	8 x 9	6908093 2908093		21 x 23	6921233 2921233	14 x 15	69114153
11	2301103	8 x 10	6908103 2908103		21 x 24	6921243 2921243	16 x 17	69116173
12	2301203	9 x 10	6909103		22 x 24	6922243 2922243	18 x 19	69118193
13	2301303	9 x 11	6909113 2909113		22 x 27	6922273 2922273	20 x 22	69120223
14	2301403	10 x 11	6910113 2910113		24 x 26	6924263 2924263	21 x 23	69121233
15	2301503	10 x 12	6910123 2910123		24 x 27	6924273 2924273	24 x 26	69124263
16	2301603	10 x 13	6910133 2910133		24 x 30	6924303 2924303	25 x 28	69125283
17	2301703	11 x 13	6911133 2911133		25 x 28	6925283 2925283	27 x 32	69127323
18	2301803	11 x 14	6911143		27 x 30	6927303 2927303		
19	2301903	12 x 13	6912133 2912133		27 x 32	6927323 2927323	3B	
20	2302003	12 x 14	6912143 2912143		30 x 32	6930323 2930323	6 x 7	29106073
21	2302103	13 x 14	6913143 2913143		30 x 34	6930343 2930343	8 x 9	29108093
22	2302203	13 x 15	6913153 2913153		30 x 36	6930363 2930363	10 x 11	29110113
23	2302303	13 x 16	6913163 2913163		32 x 36	6932363 2932363	12 x 13	29112133
24	2302403	13 x 17	6913173 2913173		34 x 36	6934363 2934363	14 x 15	29114153
27	2302703	14 x 15	6914153 2914153		36 x 41	6936413 2936413	16 x 17	29116173
30	2303003	14 x 17	6914173 2914173		41 x 46	6941463 2941463	18 x 19	29118193
32	2303203	16 x 17	6916173 2916173		46 x 50	6946503 2946503	20 x 22	29120223
36	2303603	16 x 18	6916183 2916183		55 x 60	6955603 2955603	21 x 23	29121233
38	2303803	17 x 19	6917193 2917193		65 x 70	2965703	24 x 26	29124263
41	2304103	17 x 22	6917223 2917223		75 x 80	2975803	25 x 28	29125283
46	2304603	18 x 19	6918193 2918193				27 x 32	29127323



## 1 Socket Sets

Chrome-Vanadium Steel, chromium plated,  
1/2" square drive, 24 part, 12-point sockets:

Accessories: Universal Joint, Extensions 125 and 250 mm,  
T-Slide Handle, Speeder, Ratchet (push-through type, 24 teeth)  
packed in metal box

- 1A** Art.No. **3670** Sockets: 10, 11, 12, 13, 14, 15, 16, 17, 18, 19, 20, 21, 22, 23, 24, 27, 30, 32 mm
- 1B** Art.No. **3720** same as Art.-No. 3670, but with 6-point sockets
- 1C** Art.No. **3770** Sockets: 3/8, 7/16, 1/2, 9/16, 19/32, 5/8, 11/16, 3/4, 25/32, 13/16, 7/8, 15/16, 31/32, 1, 1 1/16, 1 1/8, 1 3/16, 1 1/4" (AF)

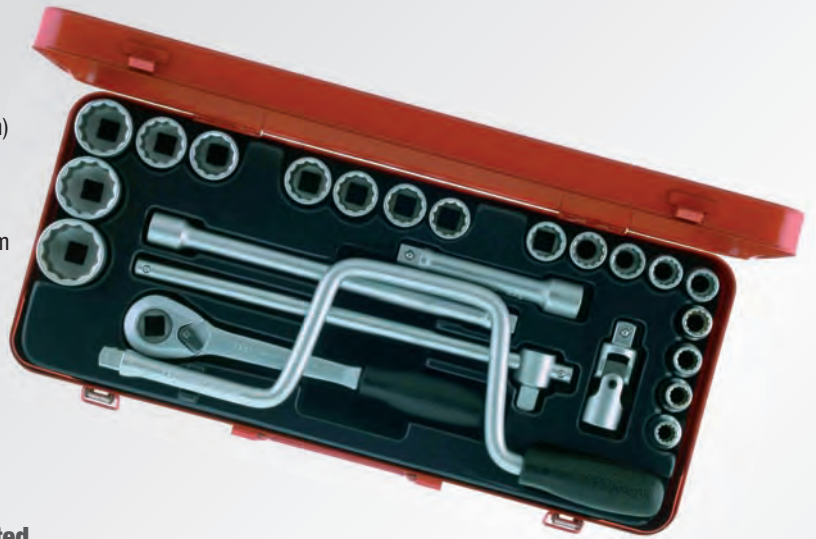

## Accessories, Chrome-Vanadium-Steel, Chromium Plated

### 2 Ratchets, push trough type



### 3 Ratchets, reversible, fine toothed type



### 4 Ratchets, reversible, lever type



### 5 Ratchets complete, reversible, fine toothed type



### 6 Extensions



### 7 Replacement Couplers



### 8 T-Slide Handles



### 9 Universal Joints



### 10 Speeders



	Square Drive	Teeth	Length (mm)	Art.No.
<b>2</b>	1/2"	24	250	<b>3230</b>
	1/4"	20	140	<b>1230</b>
	3/8"	24	200	<b>2230</b>
	3/4"	36	500	<b>4230</b>
<b>3</b>	1/2"	60	250	<b>3260</b>
	1/4"	60	140	<b>1260</b>
	3/8"	60	200	<b>2260</b>
<b>4</b>	1/2"	32	250	<b>3350</b>
	1/4"	20	140	<b>1350</b>
	3/8"	30	200	<b>2350</b>
<b>5</b>	3/4"	60	542	<b>4260</b>

	Square Drive	Length (mm)	Art.No.
<b>6</b>	1/2"	75	<b>3120</b>
		125	<b>3130</b>
		250	<b>3140</b>
		1/4"	75
		105	<b>1135</b>
		150	<b>1140</b>
	3/8"	75	<b>2120</b>
		125	<b>2130</b>
		250	<b>2140</b>
	3/4"	200	<b>4120</b>
		400	<b>4140</b>

	Square Drive	Length (mm)	Art.No.
<b>7</b>	1/4"	19	<b>1240</b>
		24	<b>2240</b>
		46	<b>4240</b>
		1/2"	300
	1/4"	115	<b>1160</b>
	3/8"	200	<b>2160</b>
	3/4"	430	<b>4160</b>
<b>8</b>	1/2"	73	<b>3110</b>
<b>9</b>	1/2"	375	<b>3200</b>

**1 Ratchet Torque Wrenches (pre-set)**

robust construction, high precision, with signal and scales in Nm and lbs/ft, right and left side measuring (Torque is set up by turning the scale)



**2 Ratchet Torque Wrenches (pre-set)**

robust construction, high precision, with signal and scales in Nm and lbs/ft, right and left side measuring (Torque is set up by the button on the top)



**3 Spark Plug Wrenches**

Chrome-Vanadium Steel, chromium plated



**4 Spark Plug Sockets**

with rubber insert or with magnet



**5 Sockets for Inhex Screws**

as per DIN 7422



**6 Sockets for TORX Screws**



**7 Double Ended Wheel Nut Wrenches,**

heavy duty pattern, chrome colour, lacquered



**8 Cross Wheel Wrenches**

hardened, silver coloured, torque acc. to DIN 3119

**8A for trucks** Art.No. **70 2000 000**

Drop Forged Steel  
24 x 27 x 32 x 38 mm  
15/16 x 1.1/16 x 1.1/2 x 1.1/4"

**8B for trucks** Art.No. **70 2000 100**

Chrome-Vanadium Steel  
19 x 22 x 24 x 27 mm  
3/4 x 7/8 x 15/16 x 1.1/6"

**8c for cars** Art.No. **70 0150 800**

Chrome-Vanadium Steel  
17 x 19 x 22 mm x 1/2"

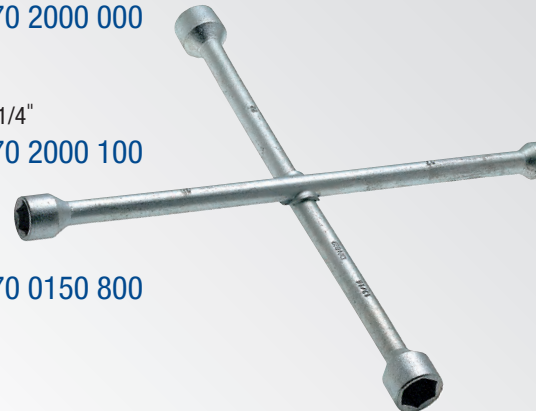

**9 Rim Wrenches**

for trucks, hardened, complete with tommy bar 500 mm

**9A hexagon on both sides**

**9B hexagon / inside square**

**9c hexagon / square**



**10 Tommy Bars** Art.No. **4318501**

fully hardened 18 x 500 mm



Drive	Torque Range (Nm / lbs.ft)	Length (mm)	Art.No.	Drive	Size (mm)	Length (mm)	Art.No.	Size (mm)	Art.No.					
<b>1</b>	1/2"	10-60 / 8-50	380	<b>3340/1</b>	<b>5</b>	1/2"	4	60	<b>3051-4</b>	<b>7</b>	24 x 27	<b>9209180</b>		
	1/2"	30-130 / 20-100	470	<b>3340/2</b>		1/2"	5	60	<b>3051-5</b>		27 x 30	<b>9216800</b>		
	1/2"	50-300 / 40-220	540	<b>3340/3</b>		1/2"	6	60	<b>3051-6</b>		30 x 32	<b>9209200</b>		
<b>2</b>	1/2"	5-50 / 5-35	365	<b>3345/1</b>		1/2"	7	60	<b>3051-7</b>	32 x 38	<b>9209220</b>	<b>9A</b>	24 x 27	<b>70 5000 002</b>
	1/2"	20-100 / 18-72	460	<b>3345/2</b>		1/2"	8	60	<b>3051-8</b>	27 x 30	<b>70 5700 002</b>		27 x 30	<b>70 5700 002</b>
	1/2"	40-220 / 30-160	530	<b>3345/3</b>		1/2"	9	60	<b>3051-9</b>	27 x 33	<b>70 5500 002</b>		27 x 33	<b>70 5500 002</b>
		Size (mm)		1/2"		10	60	<b>3051-10</b>	30 x 32	<b>70 5800 002</b>	30 x 32	<b>70 5800 002</b>		
<b>3</b>	1/2"	16 x 20.8	215	<b>0284-16x20,8</b>		1/2"	12	60	<b>3051-12</b>	30 x 33	<b>70 5900 002</b>	30 x 33	<b>70 5900 002</b>	
<b>4</b>	1/2"	16	80	<b>3095-16</b>		1/2"	14	60	<b>3051-14</b>	32 x 33	<b>70 5950 002</b>	32 x 33	<b>70 5950 002</b>	
	1/2"	18	80	<b>3095-18</b>		1/2"	17	60	<b>3051-17</b>	<b>9B</b>	1.1/16 x 1.1/4"	<b>70 3300 002</b>		
	1/2"	20.7	80	<b>3095-20,7</b>	1/2"	19	60	<b>3051-19</b>	27 x 32		<b>70 3310 002</b>			
				<b>6</b>	1/2"	T 25	52	<b>3320-T25</b>	1.1/8x1.1/4"		<b>70 3400 002</b>			
					1/2"	T 27	52	<b>3320-T27</b>	1.1/8x1.1/2"	<b>70 3100 002</b>	1.1/4x1.1/2"	<b>70 3200 002</b>		
					1/2"	T 30	52	<b>3320-T30</b>	<b>9c</b>	17 x 32	<b>70 1307 002</b>			
					1/2"	T 40	52	<b>3320-T40</b>		17 x 35	<b>70 1306 002</b>			
					1/2"	T 45	52	<b>3320-T45</b>		21 x 38	<b>70 1304 002</b>			
					1/2"	T 50	54	<b>3320-T50</b>	21 x 41	<b>70 1302 002</b>				
					1/2"	T 55	55	<b>3320-T55</b>						
					1/2"	T 60	55	<b>3320-T60</b>						







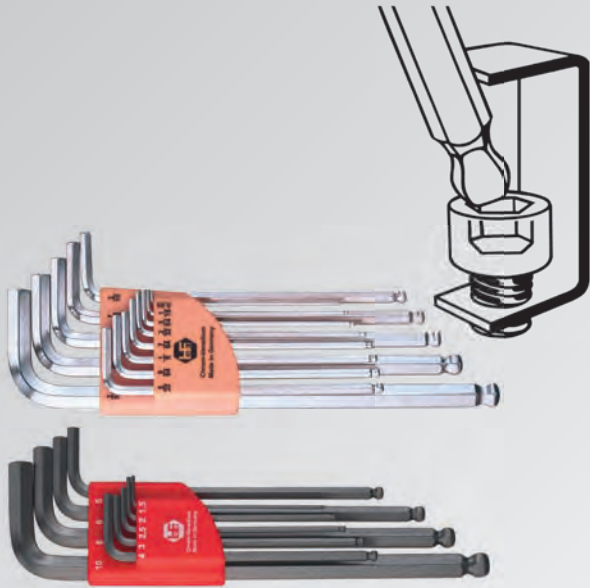

**1 451 Hexagon Key Wrenches with Ballpoint LONG** - chrome vanadium steel  
set packed in plastic clip  
**1A metric sizes**      **1B inch sizes**



**2 413 Hexagon Key Wrenches with Ballpoint EXTRA LONG** - chrome vanadium steel  
set packed in plastic wallet  
**2A metric sizes**      **2B inch sizes**



**3 525 TORX Key Wrenches LONG** - chrome vanadium steel  
set packed in plastic wallet



**4 551 TORX Key Wrenches EXTRA LONG** - chrome vanadium steel  
set packing in plastic clip

	1A				2A					1B		2B			3	4		
<b>Nickel Plated</b>	451-165-02	451-176-02	451-190-02	451-102-02	413-166-02	413-176-02	413-180-02	413-190-02	413-102-02	451-298-52	451-202-52	413-274-52	413-298-52	413-202-52	Nickel Plated	525-180-02	-	-
<b>Steel-grey</b>	451-165-08	451-176-08	451-190-08	451-102-08	413-166-08	413-176-08	413-180-08	413-190-08	413-102-08	451-298-58	451-202-58	413-274-58	413-298-58	413-202-58	Steel-grey	525-180-08	551-180-08	551-390-08
mm	6	7	9	10	6	7	8	9	10	inch	9	10	7	9	TX	8	8	9
	pcs	pcs	pcs	pcs	pcs	pcs	pcs	pcs	pcs		pcs	pcs	pcs	pcs		pcs	pcs	pcs
<b>1.5</b>	•	•	•	•	•	•	•	•	•	<b>1/16</b>	•	•	•	•	<b>9</b>	•	•	•
<b>2</b>	•	•	•	•	•	•	•	•	•	<b>5/64</b>	•	•	•	•	<b>10</b>	•	•	•
<b>2.5</b>	•	•	•	•	•	•	•	•	•	<b>3/32</b>	•	•	•	•	<b>15</b>	•	•	•
<b>3</b>	•	•	•	•	•	•	•	•	•	<b>1/8</b>	•	•	•	•	<b>20</b>	•	•	•
<b>4</b>	•	•	•	•	•	•	•	•	•	<b>5/32</b>	•	•	•	•	<b>25</b>	•	•	•
<b>5</b>	•	•	•	•	•	•	•	•	•	<b>3/16</b>	•	•	•	•	<b>27</b>	•	•	•
<b>5.5</b>										<b>7/32</b>					<b>30</b>	•	•	•
<b>6</b>	•	•	•	•	•	•	•	•	•	<b>1/4</b>	•	•	•	•	<b>40</b>	•	•	•
<b>8</b>		•	•			•	•	•		<b>5/16</b>	•	•	•	•	<b>45</b>		•	•
<b>10</b>		•	•			•	•	•		<b>3/8</b>	•	•	•	•	<b>50</b>		•	•
<b>12</b>			•					•		<b>1/2</b>	•							•

**1 Valve Spring Compressors**

bright nickel plated, for light vehicle engines

**1A with straight jaws**

**1b with straight jaws and curved jaws**

**Replacement jaws, straight, pair**

**Replacement jaws, curved, pair**



Art.No. **0500-0511**

Art.No. **0500-0512**

**2 Valve Spring Compressors**

with straight jaws and curved jaws, bright nickel plated, for heavy vehicle engines (Trucks)

**Replacement jaws, straight, pair**

Art.No. **0500-0531**

**Replacement jaws, curved, pair**

Art.No. **0500-0532**



**3 Piston Ring Pliers**

bright nickel plated, for removal and fitting of piston rings

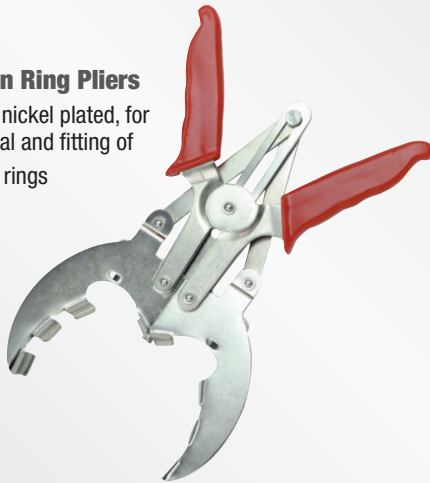

**4 Piston Ring Compressors**

with infinitely variable regulation, special spring steel, tightening strap blue



**5 Strap Wrenches**

bright nickel plated, with plastic coated handle, with non-slip textile strap

**Replacement jaws for 160 mm capacity** Art.No. **0740-0743**

**Replacement jaws for 240 mm capacity** Art.No. **0740-0744**



**6 Strap Wrenches**

chromium-plated with forged handle, made of chrome-vanadium-steel, with non-slip textile strap

**Replacement jaws for 160 mm capacity** Art.No. **0740-0746**

Capacity (mm)	Length/Height (mm)	Art.No.	Capacity (mm)	Length/Height (mm)	Art.No.
<b>70-225</b>	290	<b>0500-0500</b>	<b>160</b>	230	<b>0740-0741</b>
<b>40-225</b>	290	<b>0500-0510</b>	<b>240</b>	230	<b>0740-0742</b>
<b>85-280</b>	390	<b>0500-0520</b>	<b>280</b>	280	<b>0740-0745</b>
<b>50-100</b>	200	<b>0600-0601</b>	<b>60-80</b>	130	<b>0760-0761</b>
<b>90-150</b>	240	<b>0600-0602</b>	<b>75-110</b>	150	<b>0760-0762</b>
<b>40-75</b>	50	<b>0700-0700</b>	<b>60-80</b>	220	<b>0760-0763</b>
<b>57-125</b>	80	<b>0700-0701</b>	<b>75-110</b>	240	<b>0760-0764</b>
<b>57-125</b>	100	<b>0700-0711</b>			<b>7c</b>
<b>90-175</b>	80	<b>0700-0702</b>	<b>65-80</b>	140	<b>0760-0771</b>
<b>90-175</b>	100	<b>0700-0721</b>	<b>75-110</b>	160	<b>0760-0772</b>
<b>90-175</b>	165	<b>0700-0703</b>			<b>7d</b>
			<b>65-80</b>	210	<b>0760-0773</b>
			<b>75-110</b>	230	<b>0760-0774</b>

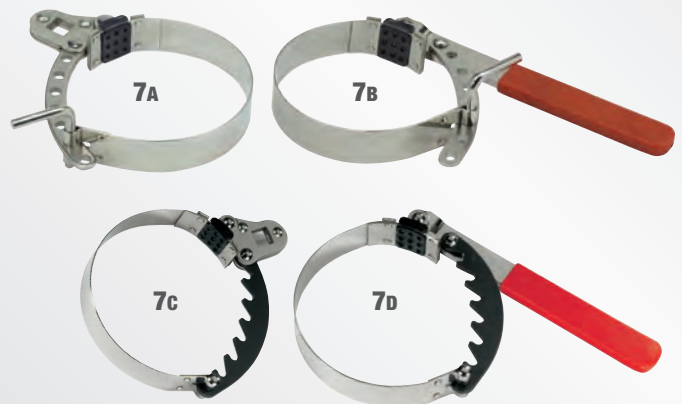

**7 Filter Wrenches**

bright nickel plated

**8A with 1/2" square drive**

**8B with plastic coated handle**

**8C with 1/2" square drive**

**8D with plastic coated handle**



- 1 Body File Holders** Art.No. **2160002**  
with adjustable aluminium handle embossed with  
made in Germany  
**length 355 mm**



- 2 Car Body File Blades**  
curved tooth  
**length 350 mm, cross section 36 x 5.5 mm**  
coarse cut Art.No. **G052301350**  
medium cut Art.No. **G052302350**  
fine cut Art.No. **G052303350**

**3 Engineers' Files - flat hand**



Size (mm - inch)	Ø (mm)	Bastard type	Second cut	Smooth cut
<b>3</b> 100 - 4"	12 x 3	900100101	900100201	900100301
125 - 5"	13 x 3	—	900120201	—
150 - 6"	15 x 4	900150101	900150201	900150301
200 - 8"	20 x 5	900200101	900200201	900200301
250 - 10"	25 x 6	900250101	900250201	900250301
300 - 12"	30 x 7	900300101	900300201	—
350 - 14"	35 x 8	900350101	900350201	—

**4 Engineers' Files - flat file - 2 flat edges**



<b>4</b> 100 - 4"	12 x 3	—	906100201	—
125 - 5"	13 x 3	906120101	906120201	—
150 - 6"	15 x 4	906150101	906150201	—
200 - 8"	20 x 5	906200101	906200201	—
250 - 10"	25 x 6	906250101	906250201	—
300 - 12"	30 x 7	906300101	—	—

**5 Engineers' Files - three square**



<b>5</b> 100 - 4"	8	912100101	912100201	912100301
125 - 5"	10	—	912120201	—
150 - 6"	11	912150101	912150201	912150301
200 - 8"	15	912200101	912200201	912200301
250 - 10"	19	912250101	912250201	912250301
300 - 12"	21	912300101	912300201	912300301
350 - 14"	24	912350101	—	—

**6 Engineers' Files - square**



<b>6</b> 100 - 4"	5	913100101	913100201	913100301
125 - 5"	5	913120101	913120201	—
150 - 6"	6	913150101	913150201	913150301
200 - 8"	8	913200101	913200201	913200301
250 - 10"	10	913250101	913250201	913250301
300 - 12"	12	913300101	913300201	913300301

**7 Engineers' Files - half round**



<b>7</b> 100 - 4"	11 x 3.5	910100101	910100201	910100301
125 - 5"	14 x 4	910120101	910120201	—
150 - 6"	16 x 4.5	910150101	910150201	910150301
200 - 8"	21 x 6	910200101	910200201	910200301
250 - 10"	25 x 7	910250101	910250201	910250301
300 - 12"	30 x 8.5	910300101	910300201	—
350 - 14"	35 x 10	910350101	910350201	—

**8 Engineers' Files - round**



<b>8</b> 100 - 4"	4	914100101	914100201	914100301
125 - 5"	5	914120101	914120201	—
150 - 6"	6	914150101	914150201	914150301
200 - 8"	8	914200101	914200201	914200301
250 - 10"	10	914250101	914250201	914250301
300 - 12"	12	914300101	914300201	—

### 1 Engineer File Sets

in PVC wallet with wooden file handle, file length 125 mm, bastard type 1

#### 3 pcs set Art.No. SET5

consisting of:

- flat hand
- half round
- round

#### 5pcs set Art.No. SET2

consisting of:

- flat hand
- half round
- round
- square
- three square

other sets and versions available on request



### 2 Key File Sets

in carton display packing with wooden file handle, file length 100 mm, second cut

#### 3 pcs set Art.No. 1003

consisting of:

- flat hand
- square
- round

#### 6pcs set Art.No. 1001

consisting of:

- flat hand
- flat with 2 flat edges
- half round
- round
- square
- three square

other sets and versions available on request

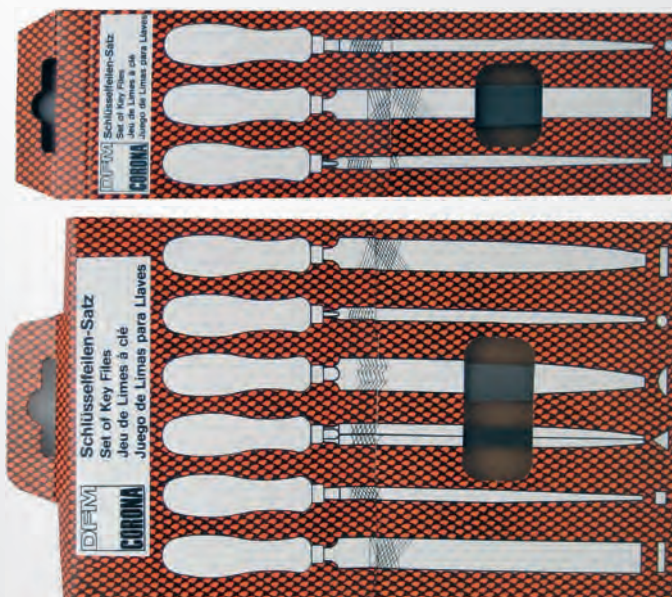

### 3 Needle File Sets

in PVC wallet with PVC file handle

#### 6pcs set

consisting of:

- flat hand
- flat with 2 flat edges
- half round
- round
- square
- three square

file length 140 mm Art.No. 983142001

file length 160 mm Art.No. 983162001

file length 180 mm Art.No. 983182001





### 1 Standard Pullers - No. 10 2-arm mechanical type

pulling legs, drop forged, in one piece. Therefore guaranteed non-bending even by extremely hard work. For swift and safe removal of wheels of any description, gears, races, ball bearings, pulleys etc.

### 2 Standard Pullers - No. 13 3-arm mechanical type

a strong triple grip puller with parallel movable legs. Can be used for external and also for internal work by simply turning pulling legs. A triple grip puller cannot tip over even by extreme use.

important notice: pulling legs, extensions and all other equipment of Standard twin grip pullers can be used in conjunction with our No. 13 triple grip pullers.

### 3 Universal Pullers - No. 16/17

a strong universal triple grip puller with parallel movable legs and large spread. Can be used for inside or outside operations. The triple grip puller cannot tip over even by extreme use.

#### 3A 2-arm mechanical type

#### 3B 3-arm mechanical type

### 4 Pullers - No. 20/21

well-known design for all pulling work. Strongly made yet light and simple to operate. Unique self-locking system ensures non-slipping of jaws - the harder the pull the tighter the grip. The pulling legs with jaws on both ends have one thin and small jaw each for use in tight places.

#### 4A 2-arm mechanical type





#### 4B 3-arm mechanical type

### 5 Pullers - No. 22/23

of sturdy yet well balanced construction for all types of application, simple to operate, very wide range. Self-locking system prevents slipping of jaws. More pressure by forcing screw automatically increases grip of jaws. Mechanical Centre Screws are interchangeable with Hydraulic Rams.

#### 5A 2-arm mechanical type

#### 5B 3-arm mechanical type

Size (mm)	Art.No.	Size (mm)	Art.No.	Size (mm)	Art.No.	Size (mm)	Art.No.	Size (mm)	Art.No.
	<b>1</b>		<b>3A</b>		<b>3B</b>		<b>4A</b>		<b>4B</b>
15-85	100	25-80	100	25-80	100	20-150	80	20-150	80
15-125	100	25-130	100	25-120	100	40-200	130	40-200	130
20-160	150	50-160	150	25-160	150				
20-200	150	60-200	150	25-200	150				
40-250	200	80-250	200	xx-250	150				
40-350	200	80-350	200	100-380	200	15-85	85	15-85	85
40-530	200	110-520	200	120-520	200	20-120	120	20-120	120
		170-640	225	120-640	200	20-165	145	20-165	145
						35-230	220	35-230	220
						50-300	270	50-300	270
						50-400	400	50-400	400
						50-500	500	50-500	500
						55-650	500	55-650	500







## Ball Joint Pullers



- 1 No. 180**  
for easy and swift removal of ball pins from the tapered housing on steering arms.



- 2 No. 181**  
particularly well suited for narrow spaces

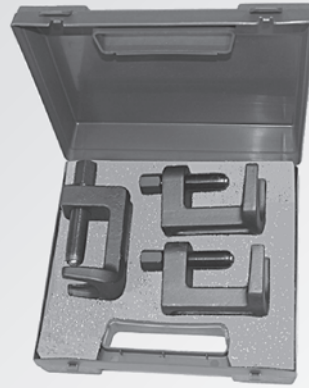

- 3 Set - K181**  
in light case  
set consisting of:  
No. 181/1, 181/2, 181/3  
Art.No. **K181**



- 4 No. 183**  
very handy, many sided and specially suited where lack of space forbids entry of direct models.



- 5 Internal Extractors - No. 50**  
for withdrawing ball bearings, races, sleeves, bushings, etc. from blind holes without damage. The well designed construction allows a safe and positive grip. Will not slip off under pressure.



- 6 Counter Stay Devices - No. 55**  
**2-arm - for Internal Extractors No.**  
50/02 - 50/3A, 50/N1 - 50/N6, 53/1 - 53/10, 57/01  
50/4 - 50/7, 53/7 - 53/14, 57/01  
50/4 - 50/8, 53/15 - 53/16, 57/0  
**3-arm - for Internal Extractors No.**  
50/02 - 50/3A, 50/N1 - 50/N6, 53/1 - 53/10, 57/01  
50/4 - 50/5, 53/7 - 53/14, 57/01

Art.No. **55/1**  
Art.No. **55/2**  
Art.No. **55/3**

Art.No. **55/13**  
Art.No. **55/23**

Opening (mm)	Width (mm)	Hight (mm)	<b>1</b> Art.No.
18	37	37	<b>180/2</b>
23	45	45	<b>180/3</b>
29	55	60	<b>180/4</b>
39	70	80	<b>180/5</b>
46	90	100	<b>180/6</b>

Opening (mm)	Hight (mm)	Suitable for	<b>2</b> Art.No.
23	55	almost all cars	<b>181/1</b>
24	45	BMW series 3	<b>181/1B</b>
28	55	Audi, VW	<b>181/2</b>
34	63	transporters	<b>181/3</b>

Opening (mm)	Hight (mm)	<b>4</b> Art.No.
22	20 - 50	<b>183/1</b>

Bore Ø (mm)	<b>5</b> Art.No.
5-6	<b>50/02</b>
6-8	<b>50/01</b>
8-12	<b>50/0</b>
12-16	<b>50/1</b>
16-20	<b>50/2</b>
20-27	<b>50/3</b>
24-30	<b>50/3A</b>
27-36	<b>50/4</b>
36-46	<b>50/5</b>
46-58	<b>50/6</b>
58-70	<b>50/7</b>
70-100	<b>50/8</b>

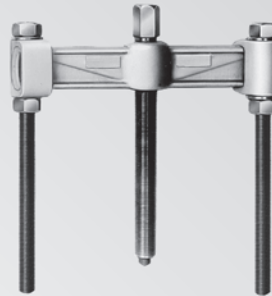
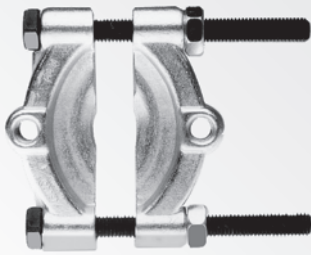

**1 Separators - No. 60**

indispensable for the removal of races, bearings, gear wheels etc. from hubs, shafts, where space is limited. The flat sides of separator halves give ample all round support.

**2 Pulling Units - No. B10**

for separators and thread adaptors

**3 Pulling Units - No. 62**

for separators and thread adaptors

**4 Sets: Separators No. 60 + Pulling Unit No. B10 mechanical type**

- 60/0 + B10/1 Art.No. **60/0 + B10/1**
- 60/1 + B10/1A Art.No. **60/1 + B10/1A**
- 60/2 + B10/2 Art.No. **60/2 + B10/2**
- 60/3 + B10/3 Art.No. **60/3 + B10/3**
- 60/4 + B10/3A Art.No. **60/4 + B10/3A**

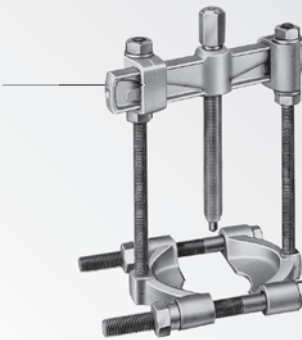

**5 Puller Sets**

in metal case, consisting of: pulling unit - extension - separator

- B10/1 - ZBV/1 - 60/0 Art.No. **K60/0**
- B10/1A - ZBV/1 - 60/1 Art.No. **K60/1**
- B10/2 - ZBV/2 - 60/2 Art.No. **K60/2**
- B10/3 - ZBV/3 - 60/3 Art.No. **K60/3**
- B10/3A - ZBV/3 - 60/4 Art.No. **K60/4**

**6 Puller Sets**

in metal case, consisting of: pulling unit - extension - separator

- 62/0 - 60/0 - ZBV1 Art.No. **K62/0**
- 62/1 - 60/1 - ZBV1 Art.No. **K62/1**
- 62/2 - 60/2 - ZBV2 Art.No. **K62/2**
- 62/3 - 60/3 - ZBV3 Art.No. **K62/3**
- 62/4 - 60/4 - ZBV3 Art.No. **K62/4**



Opening (mm)	For Use with Pulling Units	<b>1</b> Art.No.	Width (mm)	Length (mm)	For Use with Separators	<b>2</b> Art.No.	Width (mm)	Length (mm)	For Use with Separators	<b>3</b> Art.No.
5-60	B10/1 + B10/1A. 62/0	<b>60/0</b>	100	110	60/0	<b>B10/1</b>	45-110	110	60/0	<b>62/0</b>
12-75	B10/1A. 62/1	<b>60/1</b>	130	110	60/1	<b>B10/1A</b>	55-140	155	60/1	<b>62/1</b>
22-155	B10/2 + B10/2A. 62/2	<b>60/2</b>	165	185	60/2	<b>B10/2</b>	60-215	200	60/2	<b>62/2</b>
30-155	B10/3 + B10/3A. 62/3	<b>60/3</b>	205	185	60/2	<b>B10/2A</b>	85-295	315	60/2	<b>62/3</b>
30-200	B10/3A. 62/4	<b>60/4</b>	260	260	60/3	<b>B10/3</b>	120-350	305	60/3. 60/4	<b>62/4</b>
40-280	62/5	<b>60/5</b>	355	260	60/3. 60/4	<b>B10/3A</b>	140-435	320	60/5	<b>62/5</b>
			530	260	60/3. 60/4	<b>B10/4</b>				

**1 Fork Separators**

this wedge-shaped fork allows quick loosening of ball joints, shock absorbers, pitman arms etc. If confronted with cramped quarters this handy fork proves itself to have very distinct advantages over any conventional ball joint puller.

Use hammer to drive fork between parts to be separated.

**2 Coil Spring Compressor Sets**

for quick and safe mounting or removal of all usual coils. The simple yet safe clamping device avoids the breaking away of the spring while working.

It is advisable to use 3 spring compressors simultaneously evenly placed. This will avoid sagging of spring.

Long and short spindles are interchangeable.

2 pcs/set

**size 200 mm** Art.No. **909/1**

**size 300 mm** Art.No. **909/2**

**size 400 mm** Art.No. **909/3**

**3 Tyre Levers - Mounting Bars**

forged and both ends heat treated.

finish: varnish hammered silver grey

**3A straight type**

**3B s-type**

**3C knee type**

**4 Tyre Levers - 1500 (HEYCO brand)**

**4A straight type**

**4B knee type**

**4c Mercedes Benz Ref: 0005811758**

**4d Mercedes Benz Ref: 0005812158**

**5 Tyre Levers (TRILEX brand)**

**length 500 mm**

**5a rim assembling lever**

Art.No. **659 800 006**

**5b rim dismantling lever**

Art.No. **659 800 007**

**6 Tyre Lever Sets (TRILEX Type)**

consisting of assembling & dismantling lever

**size 600 x 20 mm**

Art.No. **140846020**

Fork Opening (mm)	for Ball Studs (mm)	<b>1</b> Art.No.	Length (mm)	<b>3A</b> Art.No.	<b>3B</b> Art.No.	<b>3C</b> Art.No.	<b>4A</b> Art.No.	<b>4B</b> Art.No.	<b>4c</b> Art.No.	<b>4d</b> Art.No.
18	15-25	<b>190/1</b>	<b>150</b>	2101/1	—	—	—	—	—	—
23	25-35	<b>190/2</b>	<b>200</b>	2101/2	—	—	—	—	—	—
29	30-45	<b>190/3</b>	<b>300</b>	2101/3	2104/3	2106/3	1500030080	—	—	—
40	40-60	<b>190/4</b>	<b>400</b>	2101/4	2104/4	2106/4	1500040080	1505040080	—	—
45	50-70	<b>190/5</b>	<b>450</b>	—	—	—	—	—	1509045020	—
			<b>500</b>	2101/5	2104/5	2106/5	1500050080	1505050080	—	—
			<b>600</b>	2101/6	2104/6	2106/6	1500060080	1505060080	—	1509060020
			<b>700</b>	2101/7	2104/7	2106/7	—	—	—	—

**1 Cut Rasps**

for cleaning and roughening of hole edges in the tire repair

**2 Tire Reamers**

the tire repairman's most useful tool in preparing tires for repair

**3 Tire Reamer Truck Types**

the tire repairman's most useful tool in preparing tires for repair

**4 String Closed Eyes**

for installing string in tubless tire nail-hole injuries

**5 String Split Eyes**

split eye string tool for installing all types of inserts (plugs) flat, round and oval in passenger and truck tires

**6 Insert Tools**

for installing all types of inserts (plugs) flat, round and oval in car tires

**7 Insert Tool Truck Types**

for installing all types of inserts (plugs) flat, round and oval in truck tires

**Handling**

remove



raspling



insert repair part

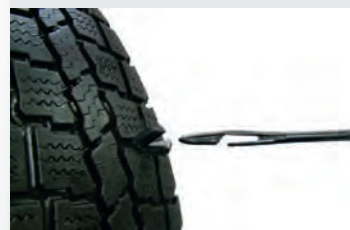

insert Tool

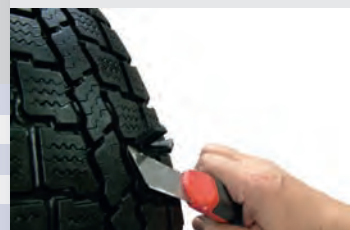

cutting

Size (mm) Art.No.

**1** 180 x 5.0 93320100  
190 x 6.5 94320200

**2** 170 x 4.5 43320000  
180 x 5.0 43320100  
190 x 6.5 44320200

**3** 265 x 5.0 46060300  
310 x 6.5 47130500

Size (mm) Art.No.

**4** 160 x 4.0 73320100  
230 x 4.0 74320200

**5** 160 x 4.0 83320100  
230 x 4.0 84320200

**6** 160 x 4.0 65320100

**7** 325 x 5.0 66130500

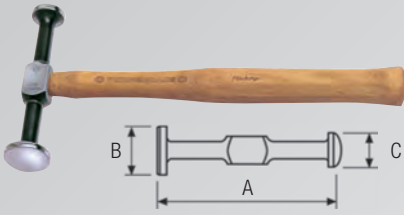

**1 Bumping Hammers**  
light execution, 2 different round faces

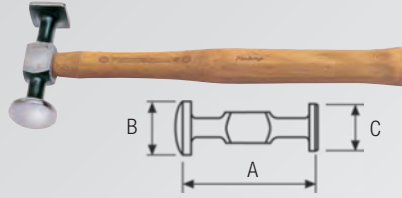

**2 Bumping Hammers**  
short execution

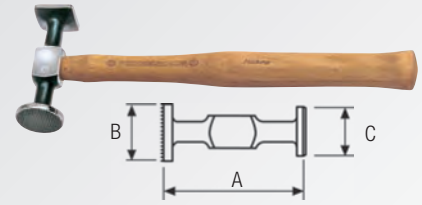

**3 Bumping Hammers**  
short execution, round face chequered

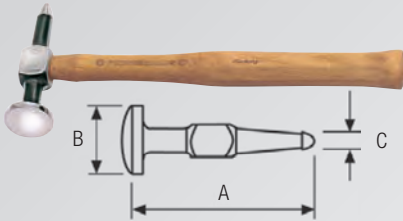

**4 Pick and Finishing Hammers**  
short execution



**5 Finishing and Grooving Hammers**

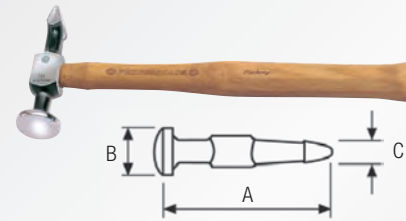

**6 Bumping Hammers**

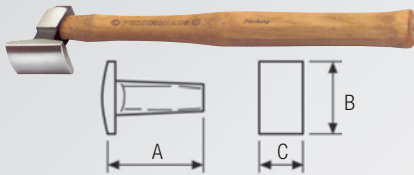

**7 Single End Planishing Hammers**  
with bowed face

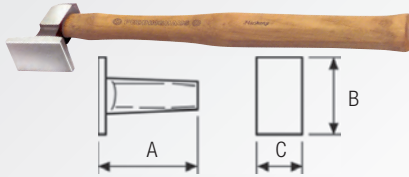

**8 Single End Planishing Hammers**  
with flat face



**9 Bumping Spoons**  
fine chequered



**10 Inside Spoons**



**11 Light Inside Spoons**



**12 Heavy Inside Spoons**

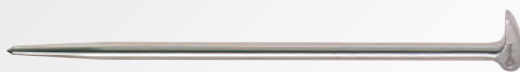

**13 Pry Bars Standard**  
Ø 14 mm



**14 Pry Bars Universal**

Type	Weight (g)	Size (mm)			Art.No.
		A	B	C	
<b>1</b>	<b>400</b>	140	40	32	<b>0170030000</b>
<b>2</b>	<b>172</b>	<b>300</b>	100	35	<b>0172030000</b>
	<b>173</b>	<b>400</b>	100	40	<b>0173030000</b>
<b>3</b>	<b>172K</b>	<b>300</b>	100	35	<b>0172530000</b>
	<b>173K</b>	<b>400</b>	100	40	<b>0173530000</b>
<b>4</b>	<b>400</b>	140	40	15	<b>0177030000</b>
<b>5</b>	<b>380</b>	160	43	5	<b>0178030000</b>
<b>6</b>	<b>330</b>	140	40	20	<b>0181030000</b>
<b>7</b>	<b>200</b>	65	50	30	<b>2058030000</b>
<b>8</b>	<b>200</b>	65	50	30	<b>2059030000</b>

Length (mm)	Working Face Length/Width (mm)	Art.No.
<b>9</b>	<b>330</b>	<b>2036010000</b>
<b>10</b>	<b>285</b>	<b>132 / 30 x 20</b>
<b>11</b>	<b>280</b>	<b>150 / 50</b>
<b>12</b>	<b>400</b>	<b>200 / 60 x 30</b>
<b>13</b>	<b>400</b>	<b>6815</b>
<b>14</b>	<b>400</b>	<b>0198010000</b>
	<b>600</b>	<b>0198010600</b>



**1 Roof Wedges**  
(curved dolly), length 130 mm,  
long curved face, 1150 g  
Art.No. [0182010000](#)



**2 Dollies**  
thin execution, length 143 mm with 55 mm  
long curved face, 780 g  
Art.No. [0182510000](#)



**3 Dollies**  
wedge form, 800g  
Art.No. [0185010000](#)



**4 Wedge Dollies**  
robust form, large face 75x6 mm  
rectangular face 45 x 25 mm, 1600 g  
Art.No. [0187010000](#)



**5 Low Crown Dollies**  
sole pattern, face curved to all sides  
face 106 x 60 mm, height 25 mm, 950 g  
Art.No. [0190010000](#)



**6 Dollies "DAIMLER"**  
face bowed, length 105 mm, width 50 mm,  
height 50 mm, 1500 g  
Art.No. [2034010000](#)



**7 Toe Dollies**  
flat and bowed face, length 115 mm,  
width 60 mm, height 28 mm, 1200 g  
Art.No. [2001010000](#)



**8 Dollies "Detroit"**  
Size 85 x 55 x 25 mm, 800 g  
Art.No. [2007010000](#)



**9 Dollies "horse shoe"**  
Size 100 x 95 x 75 mm, 1000 g  
Art.No. [2008010000](#)



**10 Toe Dollies**  
all polished, 1 face bowed and chequered,  
length 120 mm, width 60 mm, height 28 mm  
1100 g  
Art.No. [2001510000](#)

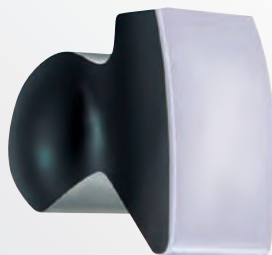

**11 Universal Dollies**  
faces 75 x 55 mm and 60 x 45 mm,  
height 57 mm, 1100 g  
Art.No. [2002010000](#)



**12 Heel Dollies**  
with round and flat face, length 80 mm,  
width 60 mm, height 35 mm, 1100 g  
Art.No. [2003010000](#)



**13 Dollies "Diabolo"**  
face 60 mm dia, height 55 mm, 850 g  
Art.No. [2004010000](#)



**14 Leather Dollies**  
with lead filling, 1700 g  
Art.No. [2100010000](#)

**1 Industrial Oilers**

single-acting brass pump with gravity controlled suction tube and aluminium spout

**1A zinc die cast container**  
colour: metallic-grey

**1B polyethylene container**  
colour: white-transparent

**2 DIY Oilers**

polyethylene container  
single-acting plastic pump and aluminium spout  
colour: white-transparent

**3 Standard Oilers - Polyethylene Container**

single-acting plastic pump  
colour: white-transparent

**3A with rigid aluminium spout**

**3B with superflex spout**

**4 Standard Oilers - Metal Container**

single-acting plastic pump, colour: red

**4A with rigid aluminium spout**

**4B with superflex spout**

**5 Industrial Oilers metal container**

single-acting brass pump with rigid aluminium and superflex spout  
colour: blue

**6 Oilers polyethylene container**

colour: transparent

**7 Oilers polyethylene container and brass spout**

colour: white-transparent

**8 Dispensing Bottle polyethylene container**

with telescopic dispensing spout  
colour: white-transparent"



Cap. (mL)	Height (mm)	Art.No.	
		1A	1B
<b>200</b>	270	03 802	04 802
<b>300</b>	320	03 803	04 803
<b>500</b>	350	03 805	04 805
<b>2</b>			
<b>150</b>	215	04 111	
<b>3A</b>			
<b>350</b>	135	05 118	05 138
<b>500</b>	150	05 119	05 139
<b>4A</b>			
<b>125</b>	110	05 111	05 121
<b>175</b>	130	05 112	05 122
<b>250</b>	110	05 113	05 133
<b>350</b>	120	05 114	05 134
<b>500</b>	150	05 115	05 135
<b>5</b>			
<b>250</b>	110	05 223	
<b>350</b>	120	05 224	
<b>500</b>	150	05 225	
<b>750</b>	200	05 226	
<b>6</b>			
<b>60</b>	120	06 068	
<b>125</b>	175	06 064	
<b>250</b>	200	06 065	
<b>500</b>	245	06 066	
<b>7</b>			
<b>50</b>	130	06 863	
<b>125</b>	160	06 864	
<b>250</b>	185	06 865	
<b>500</b>	230	06 866	
<b>8</b>			
<b>500</b>	310	06 766	

# PRESSOL

Ø (mm)	Height (mm)	Spout (mm)	Art.No.	
<b>1A</b>				
160	220		02 342	
200	280		02 344	
<b>1B</b>				
160	165	300	02 645	
200	285	300	02 344 950	
<b>2</b>				
160	220		02 352	
200	280		02 354	
<b>3</b>				
			<b>3A</b>	
50	80		02 361	
75	110		02 362	
100	130		02 363	
120	160		02 364	
150	180		02 365	
160	205		02 372	
200	220		02 366	02 366 017
250	255		02 367	02 367 020
<b>4</b>				
350	435		02 369	
<b>5</b>				
120	160		02 671	
<b>7A</b>				
			<b>7B</b>	
160	470	330	02 662	02 674
<b>7c</b>				
150	490	330	02 665	
<b>7d</b>				
160	260	260	02 562	
<b>7E</b>				
160	160	300	02 675	



**1 Funnels**  
tin plate  
**1A straight spout**  
**1B flexible metal spout**



**2 Funnels**  
galvanized sheet steel  
straight spout



**3 Funnels**  
polyethylene, straight spout,  
oil, petrol and acid resistant  
colour: orange  
**3A with removable brass strainer**



**4 Funnels**  
polyethylene  
straight spout  
colour white-transparent



**5 Oil Bottle Funnels**  
polyethylene  
oil, petrol and acid resistant  
colour: orange



**6 Funnel Sets**  
polyethylene, oil, petrol and acid resistant, colour: orange  
**4 pcs set** Ø 50, 75, 100, 120 mm  
Art.No. **02 360**  
**5 pcs set** Ø 50, 75, 100, 120, 150 mm  
Art.No. **02 360 954**  
**6 pcs set** Ø 50, 75, 100, 120, 150, 160 mm  
Art.No. **02 372 043**

**7 Funnels with Spouts**  
polyethylene, colour: orange

**7A with flexible spout**

**7B with flexible spout and removable brass strainer**

**7c with flexible removable discharge spout**  
with grip tab and integral suspension eye

**7d with angled safety spout**

**7E with flexible removable metal discharge spout**



**8 Flexible Discharge Spouts**  
polyethylene Art.No. **00 238**  
colour: orange, length: 330mm  
suitable for: 02 372, 02 662, 02 674



**metal** Art.No. **02 640**  
length: 300mm  
suitable for: 02 342, 02 344, 02 344 950,  
02 352, 02 354, 02 372, 02 645, 02 675





- 1 Measures**  
polypropylene  
calibrated with scale  
colour: transparent



**BEST  
SELLER**

- 2 Measuring  
Cylinders**  
polypropylene  
calibrated with scale  
colour: transparent



- 3 Measures**  
polypropylene  
calibrated with scale  
colour: white-transparent



- 4 Flexible Discharge Spouts** polyethylene  
length: 160 mm with sealing ring  
colour: transparent, suitable for: 07 500, 07 501  
Art.No. **00 328**  
length: 330 mm, colour: white-transparent  
suitable for: 07 502, 07 503, 07 505  
Art.No. **00 238 820**

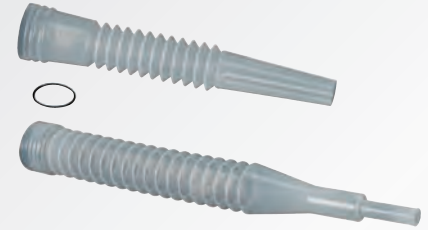

- 5 Measures**  
tin plate - polyethylene spout  
**5A** calibratable scale  
**5B** calibrated scale



- 6 Measures**  
tin plate  
with flexible metal spout



- 7 Petrol Cans**  
high density polyethylene  
with flexible spout - cover cap  
suitable for liquid fuels  
colour: red



- 8 Jerrycans - Steel**  
suitable for liquid fuels  
made of pickled sheet steel 0.9 mm  
small neck dia. 30mm, colour: olive-green  
packing: 70 pcs/pallet  
manufactured and tested to comply with  
German DIN/TÜV/GS and American AS 2906 standard  
**8A** without inside coating  
**8B** with inside coating

Capacity (Liter)	Height (mm)	Art.No.	
<b>1</b>			
<b>0.25</b>	120	<b>07 060</b>	
<b>0.5</b>	135	<b>07 061 390</b>	
<b>1.0</b>	170	<b>07 062</b>	
<b>2.0</b>	215	<b>07 063</b>	
<b>3.0</b>	240	<b>07 064</b>	
<b>5.0</b>	270	<b>07 065</b>	
<b>2</b>			
<b>0.025</b>	170	<b>07 160</b>	
<b>0.05</b>	200	<b>07 161</b>	
<b>0.10</b>	255	<b>07 162</b>	
<b>0.25</b>	310	<b>07 163</b>	
<b>0.5</b>	345	<b>07 164</b>	
<b>1.0</b>	415	<b>07 165</b>	
<b>3</b>			
<b>0.5</b>	190	<b>07 500</b>	
<b>1.0</b>	230	<b>07 501</b>	
<b>2.0</b>	290	<b>07 502</b>	
<b>3.0</b>	335	<b>07 503</b>	
<b>5.0</b>	380	<b>07 505</b>	
		<b>5A</b>	<b>5B</b>
<b>0.5</b>	230	<b>07 341</b>	<b>07 341 831</b>
<b>1.0</b>	270	<b>07 342</b>	<b>07 342 831</b>
<b>2.0</b>	320	<b>07 343</b>	<b>07 343 831</b>
<b>6</b>			
<b>1.0</b>	370	<b>07 642</b>	
<b>2.0</b>	410	<b>07 643</b>	
<b>7</b>			
<b>5.0</b>	237	<b>21 131</b>	
<b>10.0</b>	319	<b>21 133</b>	
<b>20.0</b>	410	<b>21 137</b>	
		<b>8A</b>	<b>8B</b>
<b>20.0</b>	470	<b>F-2100</b>	<b>F-2122</b>

# PRESSOL

## POSI LOK

- easy to clean due to completely removable plunger rod assemble
- high-speed ventilation of the grease gun, by half rotation of the grease gun tube
- easy removal of damaged cartridges

- 1 Standard Grease Guns**  
with hydraulic coupler with 4 jaws  
**1A with angled spout (150 mm)**  
**1B with high pressure hose (8 x 300 mm)**



- 2 Standard Grease Guns**  
with closed (fix) cover



- 3 Industrial Grease Guns**  
with angled spout (150 mm)  
precision machined coupler with 4 jaws



- 4 Industrial Grease Guns "Elite"**  
with retention adapter,  
body made of galvanized steel



- 5 One Hand Operated Grease Guns**  
with straight spout (150 mm) and  
hydraulic coupler with 4 jaws



- 6 Compressed Air Grease Guns**  
with angled spout (150 mm) and  
hydraulic coupler with 4 jaws



- 7 Compressed Air Grease Guns**  
with flex. high pressure hose  
(11 x 300 mm) and precision  
machined coupler with 4 jaws



	1A	1B	2A	2B	2c	3	4	5	6	7
Ø piston (mm)	8	8	8	8	8	9	9	8	6	6
connection M 10 x 1	•	12 638 782	12 685 782	12 686 782	•	•	12 250 12 226	18 071	18 072	
connection G 1/8"	-	-	-	-	-	•	12 270 12 276	-	-	-
wall thickness of tube (mm)	1	1	1	1	1.5	1.5	1	1	1	1
POSI LOK	•	-	-	-	•	•	•	•	•	•
variable stroke system	-	-	-	-	•	•	-	-	-	-
loading grease cartridge (g)	400	400	400/500	400/500	400	500	400	-	400	400
grip	L	T	T	T	T	T	L	L	L	L
Laquering	silver	graphite-gray	graphite-gray	graphite-gray	graphite-gray	galvanized	silver	silver	silver	silver
capacity (ccm)	<b>500</b>	<b>500</b>	<b>750</b>	<b>1000</b>	<b>500</b>	<b>750</b>	<b>500 125</b>	<b>500</b>	<b>500</b>	<b>500</b>
polybag packing	12 632	12 630	•	•	•	-	-	•	-	-
display carton packing	12 634	12 633	-	-	-	12 675	12 678	•	-	•



- 1 Button Head Couplers**  
slide on type, M 10 x 1 female,  
M- and T-nipples, 16 mm,  
size: 29 x 21 x 16 mm  
Art.No. **12 001**



- 2 Button Head Couplers**  
for button head grease nipples,  
M 10 x 1 female, 16 mm,  
size: 32 x 20 x 23 mm  
Art.No. **12 004**

- 4 Button Head Couplers**  
for button head grease nipples,  
M 10 x 1 female, 22 mm,  
size: 30 x 30 x 35 mm  
Art.No. **12 011**

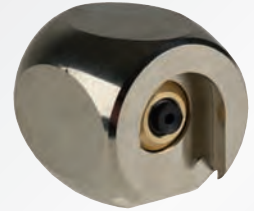

- 5 Coupling for M4-nipples**  
for button head grease nipples, M 10 x 1 fe-  
male, 12 mm, size: 32 x 20 x 26 mm  
Art.No. **12 052**

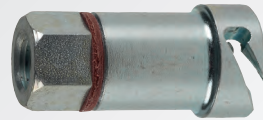

- 6 Bayonet Couplers**  
for all bayonet type grease nipples,  
M 10 x 1 female, 14 mm, size: 20 x 41 mm  
Art.No. **12 013**



- 7 Quick Release Adapters**  
for hydraulic coupler, M 10 x 1 female,  
12 mm, size: 18 x 31 mm  
Art.No. **12 006**

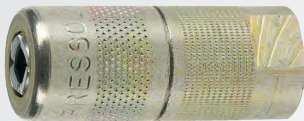

- 8 Hydraulic Couplers**  
with 4-jaws, Ø 15 mm for H-nipples, made of galvanized steel  
M 10 x 1 female Art.No. **12 631**  
G 1/8" female Art.No. **12 731**



- 9 Precision Machined Couplers**  
with 4-jaws, turned, Ø 15 mm for H-nipples, made of galvanized steel  
M 10 x 1 female Art.No. **12 643**  
G 1/8" female Art.No. **12 743**

- 10 High Pressure  
Grease Hoses  
DIN 1283**



- 11 Push Type Guns  
for Grease**  
plastic casing,  
pressure 20 bar  
**12A pointed coupler,  
funnel type**  
**12B universal coupler,  
ball type**



- 12 Push Type Guns  
for Grease and Oil**  
galvanized steel casing,  
pressure 60 up to 80 bar



Size (mm)	<b>10</b>		mL	<b>11A</b> Art.No.	<b>11B</b> Art.No.	mL	<b>12</b> Art.No.
	M 10 x 1 male	G 1/8" male					
<b>8 x 300</b>	12 656	12 756	<b>65</b>	12 321	12 331	<b>80</b>	12 362
<b>8 x 500</b>	12 666	12 766	<b>150</b>	12 322	12 332	<b>150</b>	12 363
<b>11 x 300</b>	12 655	12 755				<b>300</b>	12 365
<b>11 x 500</b>	12 665	12 765					

**1 Oil Suction Guns**

steel body - single action, with flexible transparent hose 350 mm, with PVC cover, colour: blue  
500 mL Art.No. 12 902



**BEST  
SELLER**

**2 Oil Suction Guns**

polished brass body, single action with angled brass spout (130mm) with zinc end caps  
500 mL Art.No. 12 935



**3 Oil Suction Guns**

galvanized steel body, single action with flexible transparent hose 350mm with zinc end caps  
1000 mL Art.No. 12 908



**4 Manually Operated Lubrication Systems**

manually lever operated  
discharge pressure: up to 550 bar  
burst pressure: 850 bar  
suitable for 20 kg container, Ø 270-310 mm  
dust cover (17 176)  
stabilising-fixing bracket (17 197)  
and follower plate (17 300)  
one hand operated grease gun  
connection M 10 x 1 (17 600)  
spout, straight, M 10 x 1, 150 mm (12 435)  
coupler, 4 jaws, M 10 x 1 (12 631)  
discharge hose (17 003)  
suction tube length 510 mm  
Art.No. 17 620



**5 Grease Dispenser Units**

16 kg container  
container size 220 x 380 mm  
manually operated  
discharge pressure 25 bar  
complete set with all accessories  
and foot rest  
standard colour: grey satin

**portable** Art.No. 17 791  
**mobile** Art.No. 17 792  
with 2 fixed wheels



**6 Oil Dispenser Units**

16 kg container  
container size 220 x 380 mm  
manually operated  
delivery rate/stroke 85 cm<sup>3</sup>  
complete set with all accessories  
and foot rest  
standard colour: grey satin  
**mobile** Art.No. 17 790  
with 2 fixed wheels



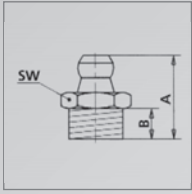

**1 Type H1**  
straight, 180°, hexagon version  
**1A galvanized 1B stainless steel**

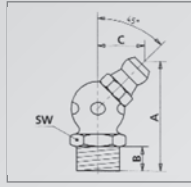

**2 Type H2 SK**  
hexagon version - 45°  
angled, galvanized

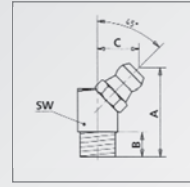

**3 Type H2 VK**  
square version - 45°  
angled, galvanized

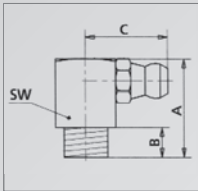

**4 Type H3 VK**  
square version - 90°  
angled, galvanized

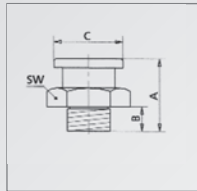

**5 M1 Button Head Grease Nipples**  
round head, hexagon version, galvanized  
C: Ø 16 mm, SW: 17 mm

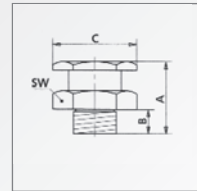

**6 T1/B Button Head Grease Nipples**  
hexagonal head, hexagon version, galvanized  
C: Ø 16 mm, SW: 15 mm

**7 Grease Nipple Assortments**

packing in transparent sales box  
**70 pcs set, various sizes**

Art.No. **16 092**

**140 pcs set, various sizes**

Art.No. **16 090**

**387 pcs set, various sizes**

Art.No. **16 099**



SW (mm)	A (mm)	B (mm)	C (mm)	Art.No.	A ((mm)	B (mm)	C (mm)	Art.No.	
<b>2</b>					<b>5</b>				
1/4" BSF	9	24	5	15 100 140	M 6 x 1	18	6.5	16	57 807
M 6 x 1	9	24	5	15 107 140	M 8 x 1	17	5.5	16	57 809
M 7 x 1	10	24	5	15 108 004	M 8 x 1,25	17.5	6.5	16	57 810
M 8 x 1	9	24	5	15 109 140	M 10 x 1	17	5	16	57 813
M 8 x 1,25	9	24.5	5	15 110 140	M 10 x 1,5	17	5.5	16	57 815
M 10 x 1	11	26	5	15 113 140	M 12 x 1,5	17	5.5	16	57 817
M 10 x 1,5	11	25.5	5	15 115 140	G 1/8"	17	5	16	57 837
<b>3</b>					<b>6</b>				
F 8 x 1, SFG	9	18	5	15 172	M 6 x 1	16	5.5	16.5	55 807
F 10 x 1, SFG	11	20	5	15 173	M 8 x 1	16	6	16.5	55 809
1/4" BSF	9	20	5	15 100	M 8 x 1,25	16	6	16.5	55 810
M 6 x 1	9	20.5	5	15 107	M 10 x 1	16	6	16.5	55 813
M 8 x 1	9	20.5	5	15 109	M 10 x 1,5	16	6	16.5	55 815
M 8 x 1,25	9	20.5	5	15 110	G 1/8"	16	6	16.5	55 837
M 10 x 1	11	20.5	5	15 113	G 1/4"	16	6	16.5	55 838
M 10 x 1,5	11	20.5	5	15 115					
G 1/8"	11	20.5	5	15 137					
<b>4</b>									
1/4" BSF	9	18	5	15 200					
M 6 x 1	9	18	5	15 207					
M 8 x 1	9	18	5	15 209					
M 8 x 1,25	9	18	5	15 210					
M 10 x 1	11	18	5	15 213					
M 10 x 1,5	11	18	5	15 215					
G 1/8"	11	18	5	15 237					

SW (mm)	A (mm)	B (mm)	Art.No.	
<b>1A</b>				
1/4" BSF	7	15	5	15 000
M 6 x 1	7	15	5	15 007
M 8 x 1	9	15	5.5	15 009
M 8 x 1,25	9	15	5	15 010
M 10 x 1	11	15	5	15 013
M 10 x 1,25	11	15	5	15 014
M 10 x 1,5	11	15	5	15 015
1/8" NPT	11	15	5	15 026
G 1/8"	11	15	5	15 037
F 6 x 1 SFG	7	15	5	15 071
G 1/4"	14	17	6	15 027 005
G 1/4"	14	16	5	15 038
<b>1B</b>				
M 6 x 1	7	15.5	5	15 907
M 8 x 1	9	17	5.5	15 909
M 10 x 1	11	17	5.5	15 913
1/8" NPT	11	17	5.5	15 926
G 1/8"	11	15	5	15 937
G 1/4"	14	17.5	6	15 938

### 1 Steel Barrel Pumps, Manual Operation

suitable for 60 L, 200 L and 220 L containers,  
suction tube length: 480 - 900 mm, steel discharge spout,

**without accessories**

delivery rate/stroke 16 L/min. Art.No. **13 012**

**with accessories**

delivery rate/stroke 16 L/min.  
with anti-drip nozzle Art.No. **13 012 954**

**without accessories**

delivery rate/stroke 10 L/min. Art.No. **13 016**



### 2 Rotary Pumps

suitable for 60 L, 200 L and 220 L containers,  
suction tube length: 980 mm, steel discharge spout,  
delivery rate/stroke 30l/min.

**without accessories**

Art.No. **13 055**

**with accessories**

complete with discharge hose 2 m length,  
hose clips, anti-kink spring Art.No. **13 056**



### 3 Waste Oil Drainers

mobile, air pressurised oil evacuation,  
drain bowl 420 mm,  
telescopic tube: 1180 - 1750 mm,  
male quick release adapter G1/4, NW 7.2  
2 fixed rear wheels, 2 front castor wheels  
standard body lacquering: grey satin  
bowl: blue

**75 L** Art.No. **27 070**



### 4 Waste Oil Suction Units VENTURI System

mobile, 2 airline connections  
male quick release adapter G 1/4, NW 7.2,  
lever ball valve with suction probe adapters  
for: VW/AUDI, Daimler Benz, BMW, Smart

2 fixed rear wheels, 2 front castor wheels,  
standard body lacquering: grey satin

**75 L** Art.No. **27 622**

**75 L** Art.No. **27 632**  
with visual inspection reservoir 7 L



### 5 Waste Oil Drainers-/Suction Units VENTURI System

mobile, 2 airline connections,  
drain bowl 420 mm,  
telescopic tube: 1180 - 1750 mm

male quick release adapter G 1/4, NW 7.2,  
lever ball valve with suction probe adapters  
for: VW/AUDI, Daimler Benz, BMW, Smart

2 fixed rear wheels, 2 front castor wheels,  
standard body lacquering: grey satin  
bowl: blue

**75 L** Art.No. **27 622 680**

**75 L** Art.No. **27 632 680**  
with visual inspection reservoir 7 L





- 1 Pneumatic Oil and Diesel Pumps 1:1**  
fresh oil supply  
pressure side: G 3/4" male  
metal container connection: G 2" male  
airline connection: G 1/4" female  
suction tube length 860 mm G 1" male  
to suit 200l/220 L metal container  
max. length of discharge hose 10 m  
Art.No. **19 135**



- 2 Pneumatic Oil Pumps 3:1**  
fresh oil supply  
pressure side: G 1/2" male  
metal container connection: G 2" male  
airline connection: G 1/4" female  
suction tube length 860 mm G 3/4" male  
to suit 200l/220 L metal container  
max. length of discharge hose 10 m  
Art.No. **19 235**



- 3 Oil Control Valves**  
swivel connection G 1/2" female, made of metal  
operating pressure: 60 bar, automatic anti-drip nozzle  
manual switch-off  
Art.No. **19 718**

- 4 Pneumatic Grease Supply Systems 50:1**  
high performance, dust cover, follower plate and adjustable stabilising-fixing bracket  
high-pressure grease control gun, 360 degree Z-swivel connector  
high-pressure grease hose 2 m, pressure reduction valve (8 bar pre-set) male quick release airline connector

**4A mobile**

**to suit 20 kg container**

with trolley Ø 270-310 mm with 2 m grease hose

Art.No. **18 417 051**

**to suit 200 kg container**

with trolley Ø 540-590 mm with 6 m grease hose

Art.No. **18 786 056**

**4B stationary**

**to suit 20 kg container** Ø 270-310 mm with 2 m grease hose

Art.No. **18 419 051**

**to suit 200 kg container** Ø 540-590 mm with 6 m grease hose

Art.No. **18 785 056**



- 5 Pneumatic Grease Supply Systems 50:1**

high performance - suction tube  
dust cover, follower plate and adjustable stabilising-fixing bracket  
pressure reduction valve (8 bar pre-set)  
airline connection: G 1/4"

**to suit 20-30 kg container** Ø 270-310 mm Art.No. **18 740 051**

**to suit 200 kg container** Ø 540-590 mm Art.No. **18 780 051**



- 6 Pneumatic Grease Pumps 50:1**

recommended air pressure: 8 bar (min. 2 bar/max. 10 bar)  
cylinder capacity engine 220 cm<sup>3</sup>, cylinder capacity pump 8 cm<sup>3</sup>  
quantity of strokes at 8 bar at a free-flow: 220 min.  
pump capacity at 8 bar at a free-flow: 1100 g/min  
pump pressure at 8 bar air pressure: 400 bar  
air consumption at 8 bar air pressure: 400 L/min  
airline connection: G 1/4"

suction tube length:

600 mm, **to suit 20-30 kg container**

Art.No. **18 711 051**

700 mm, **to suit 25-60 kg container**

Art.No. **18 713 051**

1000 mm, **to suit 200 kg container**

Art.No. **18 716 051**





- 1 High Pressure Grease Control Guns**  
with hydraulic 4-claw coupler H, angled spout
- G 1/8" female** Art.No. **18 104**
  - G 1/4" female** Art.No. **18 114**

- 2 Rotary Swivel Connectors**  
connection G1/8" male, G 1/4" female, finish: yellow galvanized steel
- Z-swivel connector 3 x 360°** Art.No. **18 082**
  - swivel connector 2 x 360°** Art.No. **18 083**

- 3 Maintenance Units**  
complete with pressure regulator, manometer, moisture separator and in-line lubricator, recommended for use with pneumatic oil and grease pumps
- connection: G 1/4" male, operating pressure 10 bar with male quick release coupler
- Art.No. **20 218 950**



- 4 Construction Kits for Oil - Grease and Water/Air supply**  
Wall/Floor mounting versions
- 4A Open Hose Reels**
  - 4B Encased Hose Reels**  
outside swivel



- 5 PREMAxx Dieselpumpsets**  
not selfpriming with 4 m discharge hose and 1.6 m suction hose with on-off switch and motor-thermal-protection  
connection: G 1" female, for 200 L containers and tanks
- 6 MOBIFlx Dieselpumpsets**  
selfpriming with 4 m discharge hose and 1.6 m suction hose with on-off switch and 3,0 m electric connection cable  
connection: G 1" female, for 200 L containers and tanks

L/min. V/Hz	Control Gun	with...	Art.No.
<b>52</b>	230/50	standard	2 pin plug <b>23 731</b>
<b>52</b>	230/50	automatik shutt-off	2 pin plug <b>23 737</b>
<b>52</b>	230/50	standard	13A BS plug <b>23 731 932</b>
<b>52</b>	230/50	automatik shutt-off	13A BS plug <b>23 737 932</b>
<b>43</b>	24	standard	tapping clamps <b>23 721</b>
<b>43</b>	24	automatik shutt-off	tapping clamps <b>23 727</b>
<b>38</b>	12	standard	tapping clamps <b>23 711</b>
<b>38</b>	12	automatik shutt-off	tapping clamps <b>23 717</b>

Hose Reel	Bar	DN	Connection Threads	4A		4B	
				10 m	15m	10 m	15 m
<b>oil</b>	120	12	G 1/2" male and female	<b>29 142</b>	<b>29 143</b>	<b>29 172</b>	<b>29 173</b>
<b>grease</b>	400	6	G 1/4" male and female	<b>29 242</b>	<b>29 243</b>	<b>29 272</b>	<b>29 273</b>
<b>water/air</b>	20	10	G 3/8" male and female	<b>29 442</b>	<b>29 443</b>	<b>29 472</b>	<b>29 473</b>
<b>cooling agent</b>	120	12	G 1/2" male and female	<b>29 542</b>	<b>29 543</b>	<b>29 572</b>	<b>29 573</b>
<b>hot water</b>	200	10	G 3/8" male and female	<b>29 742</b>	<b>29 743</b>	<b>29 772</b>	<b>29 773</b>

			Art.No.
<b>35</b>	12	standard	tapping clamps <b>23 015</b>
<b>35</b>	12	automatik shutt-off	tapping clamps <b>23 006</b>
<b>35</b>	24	standard	tapping clamps <b>23 015 824</b>
<b>35</b>	24	automatik shutt-off	tapping clamps <b>23 006 824</b>



**1 Sprayers for Use in Household**

polyethylene container,  
pump sprayer with PVC nozzle,  
height 280 mm, capacity 750 mL  
**for water based/non aggressive - liquids**  
colour: orange  
Art.No. **06 266**  
**for water and distilled water**  
colour: white-transparent  
Art.No. **06 266 820**

**2 Industrial Sprayers**

polyethylene container,  
pump sprayer with PVC nozzle  
for various chemicals e.g. detergents, solvents  
and cleaning agents, not suitable for acetone,  
glykol, break cleaners and acetic acid  
height 290 mm, capacity 750 mL  
**colour: orange white-transparent**  
Art.No. **06 267 06 267 820**

**3 POMPAXx Industrial Sprayers**

polyethylene container, complete with spray lance, connecting  
hose 1.2 m, safety valve, UV-resistant, packing in sales  
promoting display carton, recommended for cleaning,  
disinfecting and spraying of concrete formwork oil  
colour: white-transparent

**capacity 1 L** height 285 mm

Art.No. **06 178**

**capacity 2 L** height 300 mm

Art.No. **06 902**

**capacity 5 L** height 520 mm

Art.No. **06 905**

**capacity 10 L** height 570 mm

Art.No. **06 910**

**4 Hobby 05 / 10**

Fine Sprayer - double acting precision pump,  
1 x pump = 2 x spray - adjustable nozzle with brass insert,  
transparent level indicator, container made of high-quality plastic



**4A Hobby 05** capacity **0.5 L**

Art.No. **Hobby 05**

**4B Hobby 10** capacity **1.25 L**

Art.No. **Hobby 10**

**5 Hobby 100 / 125**

Pressure Sprayer for homes and gardens, operating pressure  
max. 3 bar, adjustable nozzle incl. brass insert, transparent level  
indicator strip, container made of high-quality plastic

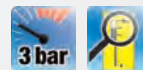

**5A Hobby 100** capacity **1.0 L**

Art.No. **Hobby 100**

**5B Hobby 125** capacity **1.25 L**

Art.No. **Hobby 125**



with 360° spraying  
thanks to flexible  
rising tube

**6 Prima 3 / 5 / 8**

high quality plastic, powerful  
pressure pump, integral safety valve,  
lance and hose, carrying straps

**6A Prima 3** capacity **3.0 L**

Art.No. **Prima 3**

**6B Prima 5** capacity **5.0 L**

Art.No. **Prima 5**

**6C Prima 8** capacity **8.0 L**

Art.No. **Prima 8**

colour coded pressure guide,  
trigger control, adjustable nozzle





**Foam Masters** models are a powerful range of pressure sprayers for applying cleaning foam

**1 Foam Master 10**

Art.No.	FM10
Filling capacity	1.25 L
Max. operating pressure	3 bar
Material of container	impact-resistant plastic
Pump	high performance pump
Other equipment	with flat fanspray nozzle



**2 Foam Master 50**

Art.No.	FM50
Filling capacity	8 L
Max. operating pressure	3 bar
Material of container	impact-resistant plastic
Pump	powerful pressure pump
Other equipment	spiral hose, quick-action valve with pressure flat fanspray nozzle, reducing valve and manometer, plastic spray lance with flat jet nozzle, bottom ring, spray lance holder, carrying straps



**3 Pro 5**

Art.No.	81
Filling capacity	5 L
Max. operating pressure	3 bar
Material of container	oil-resistant plastic
Pump	high performance pump
Other equipment	brass spray lance, adjustable nozzle, safety valve, portable on shoulder



**4 Pro 8**

Art.No.	92
Filling capacity	8 L
Max. operating pressure	3 bar
Material of container	oil-resistant plastic
Pump	high performance pump
Other equipment	brass spray lance, adjustable nozzle, safety valve, portable on shoulder



**High Performance Sprayers**



**5 405 T**



**6 410 T**



**5 505 T**



**6 510 T**

Art.No.	405T	410T	505T	510T
Filling capacity	5 L	10 L	5 L	10 L
Max. operating pressure	6 bar		6 bar	
Material of container	steel with high-quality plastic interior coating		stainless steel (non-corroding)	
Pressure Gauge	•		•	
Other equipment	safety relief and ventilating valve brass spray lance, carrying strap		safety relief and ventilating valve brass spray lance, carrying strap	

**9 Piston Knapsack Sprayers Typ 2016**

Art.No.	2016
Filling capacity	16 L
Material of container	stainless steel (non-corroding)
Pump	powerful plastic pump
Other equipment	with indicator pressure gauge, brass spray lance and extension lance 0.5 m, stable swivelling pump lever, carrying straps



**10 Piston Knapsack Sprayers Typ Hobby 1018**

Art.No.	1018
Filling capacity	18 L
Material of container	heavy duty plastic
Pump	powerful plastic pump
Other equipment	with indicator pressure gauge, brass spray lance and extension lance 0.5 m, stable swivelling pump lever, padded shoulder carrying straps with quick-tensioning system





### 1 Water Hose Reels WS 32

the light, practical and mobile water hose extension, special hose with textile inlay and spiral wound cross-weave, with a spraying nozzle with waterstop and a top connector, drum is made of special highly breakproof plastic, strong carrying frame made of galvanized tubular steel

hose length 20 m, Ø 1/2"

1pc

Art.No. 1237120

sales pallet = 30 pcs/pallet

Art.No. 1237120 030



### 2 Compressor Hose Reels

with high-quality fabric hose, oil-resistant, up to 15 bar of pressure, complete with quick release couplings, drum is made of special highly breakproof plastic

hose length 20 m, Ø 6 x 12 mm

#### 2A Standard

frame made of steel tubing with bright galvanised zinc

Art.No. 1127020

#### 2B Anti Twist

with axial connection permitting rolling up or out during operation, throughflow system, axial connection, permitting it to be rolled up or out, even during operation, with connection hose, and wall mounting, frame made of steel tubing with bright galvanised zinc coating

Art.No. 1127010

### 3 Regulators

with wall screw clamp, pressure adjusting range 0-12 bar, blue colour, with pressure gauge thread



### 4 Lubricators

suitable for filtered air, with wall screw clamp, blue colour,

4A 12 bar with transparent cup

4B 18 bar with metal cup



### 5 Filter Regulators

with wall screw clamp and pressure gauge thread, blue colour

5A pressure adjusting range 0-12 bar with transparent cup

5B pressure adjusting range 0-18 bar with metal cup



### 6 Filters

with wall screw clamp, blue colour

6A pressure adjusting range 0-12 bar with transparent cup

6B pressure adjusting range 0-18 bar with metal cup



### 7 Filter Regulators + Lubricators

with wall screw clamp, blue colour

7A pressure adjusting range 0-12 bar with transparent cup

7B pressure adjusting range 0-18 bar with metal cup



### 8 Filters + Regulators + Lubricators

with wall screw clamp, blue colour

8A pressure adjusting range 0-12 bar with transparent cup

8B pressure adjusting range 0-18 bar with metal cup



thread (inch)	3 Art.No.	4A Art.No.	4B Art.No.	5A Art.No.	5B Art.No.	6A Art.No.	6B Art.No.	7A Art.No.	7B Art.No.	8A Art.No.	8B Art.No.
1/8"	AT-R18	AT-L18	AT-LM18	AT-FR18	AT-FRM18	AT-F18	AT-FM18	AT-FR+L18	AT-FR+LM18	AT-F+R+L18	AT-F+R+LM18
1/4"	AT-R14	AT-L14	AT-LM14	AT-FR14	AT-FRM14	AT-F14	AT-FM14	AT-FR+L14	AT-FR+LM14	AT-F+R+L14	AT-F+R+LM14
3/8"-1/2"	AT-R12	AT-L12	AT-LM12	AT-FR12	AT-FRM12	AT-F12	AT-FM12	AT-FR+L12	AT-FR+LM12	AT-F+R+L12	AT-F+R+LM12
3/4"	AT-R34		AT-LM34		AT-FRM34		AT-FM34		AT-FR+LM34		AT-F+R+LM34
1"	AT-R1		AT-LM1		AT-FRM1		AT-FM1		AT-FR+LM1		AT-F+R+LM1

100% MADE IN ITALY

**1 Pressure Filter Regulators**

with lower connection (inf.) or rear connection (post.)  
two adjustable air outlets with gauge Ø 50 mm  
aluminium body

**1A** bayonet coupler

**1B** automatic coupler type universal



**2 Pin Cocks**

1/4" connection with bayonet

Art.No. **RS**



**3 Paint Spray Guns** packing in coloured single display box

**3A 1400/1**

with gravity cup-GR 500  
nylon cover, needle 1.5 mm

Art.No. **701400**



**3B 1410/1**

with suction cup-GR 1000  
aluminium cover, needle 1.5 mm

Art.No. **701410**



**3c 1420/1**

with suction cup-GR 1000  
PVC cover, needle 1.5 mm

Art.No. **701420**



**3D 1412**

with suction cup-GR 1000  
with Cam Lock, aluminium cover, needle 1.7 mm

Art.No. **701412**



**4 Washing Guns** packing: 2 pcs/carton

**4A 1300/1**

GR 1000-tank and cover made from aluminium

Art.No. **751300**



**4B 1310/1**

GR 1000-M30 red steel tank

Art.No. **751310**



**5 Blow Guns** in bulk packing

**5A 1100/1**

with std. tube

Art.No. **751100**



**5B 1110/1**

with long tube

Art.No. **751110**

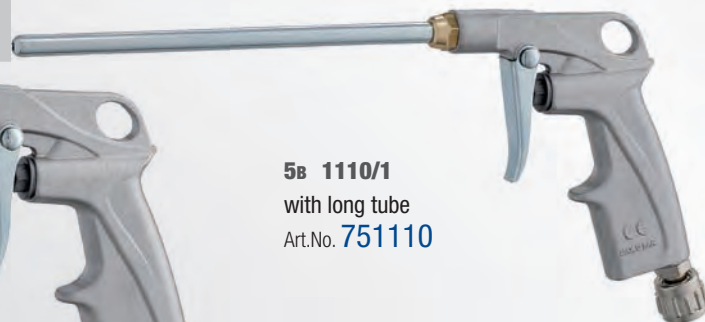

connection (inch)	<b>1B</b> Art.No.	<b>1B</b> Art.No.
<b>lower connection 3/8"</b>	<b>R10-INF.3/8"</b>	<b>R10UNI-INF.3/8"</b>
<b>lower connection 1/2"</b>	<b>R14-INF.1/2"</b>	<b>R14UNI-INF.1/2"</b>
<b>rear connection 1/4"</b>	<b>R10-POST.1/4"</b>	<b>R10UNI-POST.1/4"</b>
<b>rear connection 3/8"</b>	<b>R14-POST.3/8"</b>	<b>R14UNI-POST.3/8"</b>

### 1 Tyre Inflating Guns 1200/1

with pressure gauge Ø 63 mm (marked with "Made in Italy"), in strong display box packing  
Art.No. **751200**



### 2 Tyre Control Pressure Gauges 1215/G

with pressure gauge Ø 63 mm (marked with "Made in Italy"), 0-12 bar, with 40 cm tube with chuck for direct attachment to the valve, in strong display box packing  
Art.No. **751215-G**



### 3 Tyre Inflating Chucks

clip on connectors

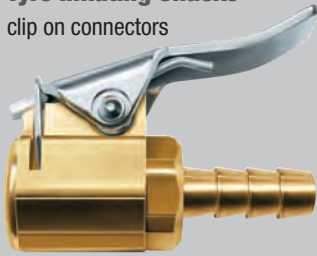

### 4 Tyre Inflating Chucks for Earth Movers

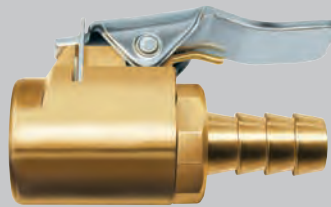

### 5 Clip-on Ball Foot Air Chucks

self-closing after detaching from tyre valve (closed end)



### 6 Clip-on Ball Foot Air Chucks with female thread

self-closing after detaching from tyre valve (closed end)

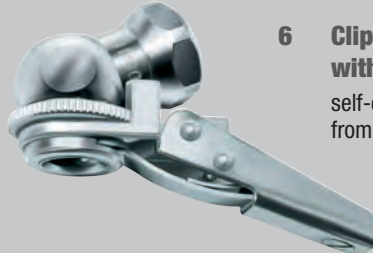

### 7 Service Station Tyre Inflating Air Chucks

7A



7B



### 8 Car Washing Guns

made of brass  
- connection to 1/2" hose, max. 40 bar - max. +90°C  
with 1 mounted nozzle and 1 spare-nozzle



**BEST SELLER**

Ø (mm)	For hose in. Ø (mm)	3 Art.No.	4 Art.No.	5 Art.No.	6 Art.No.	7A Art.No.	7B Art.No.	Fitted nozzle (mm)	Spare nozzle (mm)	8 Art.No.
6	5	14.3000						2	4	160.04/2+4
8	7	14.3100	14.3400	14.4151		14.6602	14.6410	2	2	160.04/2
9	8			14.4171		14.6805	14.6450	3	3	160.04/3
								4	4	160.04/4
								<b>w.o nozzle</b>		160.00
Ø (inch)										
1/4" - 18NPT					14.5451					
1/8" - 27NPT					14.5851					

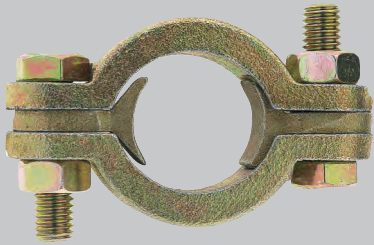

**1 Hose Clamps DIN 20039 A**

robust clamps of malleable iron, zinc plated and yellow passivated with two parts with loose saddles

**2-3 Claw Couplings**

robust couplings of malleable iron, zinc plated and yellow passivated



**2A Hose (formerly DIN 3483)**



**2B Female (formerly DIN 3482)**



**2C Male (formerly DIN 3481)**

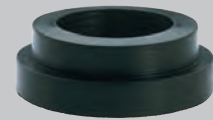

**2D Original Rubber Ring**

for standard claw couplings  
DIN 3489 made of Perbunan,  
oil resistant  
Art.No. **GOER**



**3A US-Hose with safety collar**



**3B US-Female**



**3C US-Male**

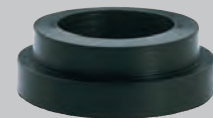

**3D Original Rubber Ring**

made of Perbunan,  
oil resistant

Art.No. **GOOR**

<b>1A</b>	for Hose Ø	Hose Outer
Art.No.	(inch = mm)	Ø/Range
SL29	1/2" = 13	22-29
SL34	3/4" = 19	28-34
SL40	1" = 25	32-40
SL49	1.1/4" = 32	39-49
SL60	1.1/2" = 38	48-60
SL72	2" = 50	56-72
SL94	2.1/2" = 63	77-94
SL400	3" = 75	89-101
SL115	3" = 75	94-115
SL525	3.1/2" = 89	113-127
SL145	3.1/2" = 89	115-145
SL550	4" = 100	127-140
SL600	4" = 100	135-155
SL675	5" = 125	155-175
SL769	6" = 150	175-195
SL875	7" = 175	210-225
SL988	8" = 200	227-250

<b>2A</b>	Hose Ø
Art.No.	(inch = mm)
SKG6	1/4" = 6
SKG10	3/8" = 10
SKG13	1/2" = 13
SKG15	5/8" = 15
SKG19	3/4" = 19
SKG25	1" = 25
SKG32	1.1/4" = 32

<b>3A</b>	Hose Ø
Art.No.	(inch = mm)
SKA11	3/8" = 10
SKA13	1/2" = 13
SKA19	3/4" = 19
SKA25	1" = 25

Thread	<b>2B</b>	<b>2C</b>
G (inch)	Art.No.	Art.No.
1/4"	KIG14	KAG14
3/8"	KIG38	KAG38
1/2"	KIG12	KAG12
3/4"	KIG34	KAG34
1"	KIG10	KAG10
1.1/4"	KIG54	KAG54

Thread	<b>3B</b>	<b>3C</b>
(inch) NPT	Art.No.	Art.No.
3/8"	KIA38	KA38
1/2"	KIA12	KA12
3/4"	KIA34	KA34
1"	KIA10	KA10

## 1 Standard Quick-Disconnect Couplings DN 7,2

universal quick-disconnect couplings made of brass blank, new stem profile for safe fit of the hose and easy assembly

1A Couplings with male thread

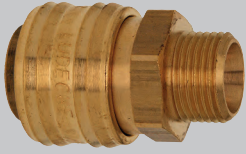

1B Couplings with female thread

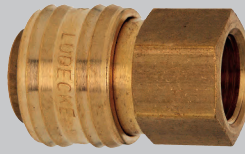

1C Couplings with hose stem



1D Plugs with male thread

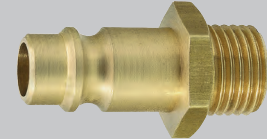

1E Plugs with female thread

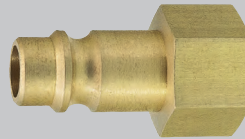

1F Plugs with hose stem



## 2 Distributors for Quick-Disconnect Couplings DN 7,2 Assembled

of brass MS 58, for compressed air distribution on central places



2A 3-Way-Distributors



2B 4-Way-Distributors

## 3 Quick-Disconnect Couplings DN 5 US Design

made of brass, new stem profile for safe fit of the hose and easy assembly

3A Couplings with male thread

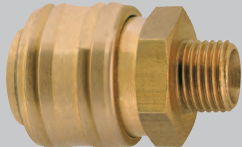

3B Couplings with female thread

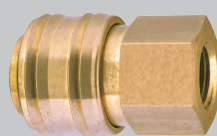

3C Couplings with hose stem



3D Plugs with hose stem



Thread	1A	1B	1D	1E	Hose Ø (mm)	1C	1F	Inlet G female (inch)	Outlet	Art.No.
	Art.No.	Art.No.	Art.No.	Art.No.		Art.No.	Art.No.			
G 1/8"	ES18A	ES18I	ES18NA	ES18NI	4		ES4S			<b>2A</b>
G 1/4"	ES14A	ES14I	ES14NA	ES14NI	6	ES6T	ES6S	3/8"	2 x ES38A	DWS38ES
G 3/8"	ES38A	ES38I	ES38NA	ES38NI	8	ES8T	ES8S	1/2"	2 x ES12A	DWS12ES
G 1/2"	ES12A	ES12I	ES12NA	ES12NI	9	ES9T	ES9S			<b>2B</b>
M 14 x 1,5	ES1415A	ES1415I	ES1415NA	ES1415NI	10		ES10S	3/8"	3 x ES38A	VWS38ES
M 16 x 1,5	ES1615A	ES1615I	ES1615NA	ES1615NI	13	ES13T	ES13S	1/2"	3 x ES12A	VWS12ES
M 18 x 1,5	ES1815A	ES1815I	ES1815NA	ES1815NI						

Thread	3A	3B	Hose Ø (mm)	3C	3D
	Art.No.	Art.No.		Art.No.	Art.No.
1/4" NPT	ESA14A	ESA14I	6	ESA6T	ESA6S
3/8" NPT	ESA38A	ESA38I	9	ESA9T	ESA9S
1/2" NPT	ESA12A	ESA12I	13	ESA13T	ESA13S

**1 Pneumatic-1/3-Connectors**

made of brass, thread Stems with male thread parallel and inner cone 37°

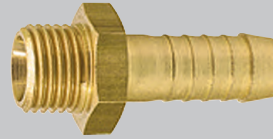

**2 Pneumatic-2/3-Connectors**

made of brass

**2A Hexagon Nuts**

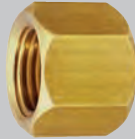

**2B Hose Stems for Hexagon Nuts (with outer cone)**

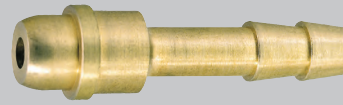

**2c Pneumatic Double Nipples**

with male thread and inner cone 37°

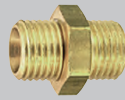

**2d Pneumatic Hose Menders**

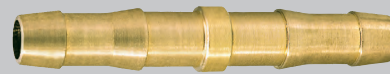

**2E Pneumatic Reducing Nipples**

with female thread, male thread and hexagon



**3 Hexagon Ball Valves**

miniatur ball valves of brass, nickel plated for pneumatic or water installations in industrie

**3A with 2 x female thread**

**3B with female/male thread**

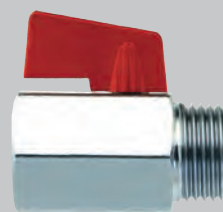

Art.No.	Bore	Thread G (inch)	Hose Ø (mm)	Art.No.	Thread 1 - Thread 2 G (inch)	Hose Ø (mm)	Art.No.	Female - Male Thread G (inch)	Hose Ø (mm)
<b>1</b> T186M		1/8"	6	<b>2c</b> D18M	1/8" - 1/8"		<b>2d</b> SV6M		6
T189M		1/8"	9	D84M	1/8" - 1/4"		SV8M		8
T146M		1/4"	6	D14M	1/4" - 1/4"		SV9M		9
T148M		1/4"	8	D48M	1/4" - 3/8"		SV11M		11
T149M		1/4"	9	D42M	1/4" - 1/2"		SV13M		13
T1411M		1/4"	11	D38M	3/8" - 3/8"		SV19M		19
T1413M		1/4"	13	D82M	3/8" - 1/2"		SV25M		25
T386M		3/8"	6	D12M	1/2" - 1/2"		<b>2E</b> R84N	1/8" - 1/4"	
T388M		3/8"	8	<b>2B</b> ST186M	( for nut U18M)	6	R48N	1/4" - 3/8"	
T389M		3/8"	9	ST146M	( for nut U14M)	6	R42N	1/4" - 1/2"	
T3811M		3/8"	11	ST149M	( for nut U14M)	9	R82N	3/8" - 1/2"	
T3813M		3/8"	13	ST386M	( for nut U38M)	6	R24NM	1/2" - 3/4"	
T126M		1/2"	6	ST389M	( for nut U38M)	9	R21N	1/2" - 1/1"	
T129M		1/2"	9	ST3811M	( for nut U38M)	11	<b>3A</b> KM14TS	1/4"	
T1213M		1/2"	13	ST126M	( for nut U12M)	6	KM38TS	3/8"	
T3419TM		3/4"	19	ST129M	( for nut U12M)	9	KM12TS	1/2"	
T1025TM		1/1"	25	ST1213M	( for nut U12M)	13	<b>3B</b> KMZ14TS	1/4"	
<b>2A</b> U18M	7.2	1/8"					KMZ38TS	3/8"	
U14M	10.6	1/4"					KMZ12TS	1/2"	
U38M	13	3/8"							
U12M	15.5	1/2"							



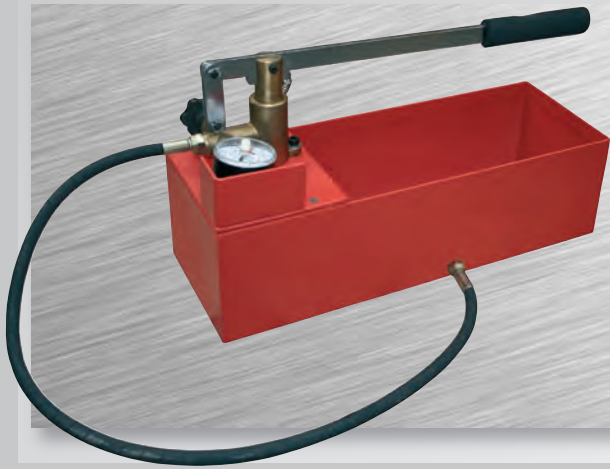

**1 KISTENMACHER Testing Pumps TP5**

testing pumps in monoblock design 0 - 60 bar,  
tank: painted in epoxy powder red color semi-texturized  
working lever: zinc plated

manometers:  
(0-60 bar) - (0-860 psi)

pressure gauge connection: 1/4" bsp.  
out going pipe connection: 1/2" bsp.  
hose with two connections of 1/2" bsp.

capacity: 10 L  
Art.No. **TP-5**

**BEST  
SELLER**



Testing and pressure range

Hub suction capacity  
Tank capacity  
Connection  
Art.No.

**2 Hand-Operated Test Pumps with twin-valve technology**

**RP50**

precision testing pumps  
in monoblock design 0 - 60 bar

**TP25**

small testing pump  
for compression testing 0 - 25 bar

0 - 60 bar, with 1 bar steps  
0 - 860 psi, with 20 psi steps  
0 - 6 MPa, with 0,1 MPa steps

0 - 25 bar

approx. 45 mL / stroke

approx. 16 mL / stroke

12 L

7 L

R 1/2"

R 1/2"

**6.0200**

**6.0250**

**3 Hand-Operated Test Pumps with pressure gauge connection 1/2"**



**HP 300**

**HP 220**



**HP 500F**

Specifications

single-stage design

single-stage design

double-stage test pump (two plungers) for a higher volume

Plunger Ø

30 mm

22 mm

50/16 mm

Capacity/Volume

24 cm<sup>3</sup>

13 cm<sup>3</sup>

75 cm<sup>3</sup>

Test pressure

60 bar

100 bar

200 bar

Stationary type

**HP300**

**HP220**

**HP500**

Mobile type

**HP300**

**HP220**

**HP500M**

**4 Hight Pressure Hand-Operated Test Pumps with pressure gauge connection 1/2" and safety valve**

**HP 12**

**HP 8**

Plunger Ø

32/12 mm

32/8 mm

Capacity/Volume

28 cm<sup>3</sup>

28 cm<sup>3</sup>

Test pressure

630 bar

1000 bar

Stationary type

**HP/12**

**HP/8**

Mobile type

**HP/12M**

**HP/8M**





### 1 Quality Plastic Extension Cables



### brennenstuhl

### 2 Quality Plastic Extension Cables with wallhanger



### 3 Comfort Line CL-S Cable Boxes with earthed socket outlets



### 4 Vario Line Domestic Cable Reels

robust casing, made of special plastic with earthed socket outlets



	Art.No.	UP	Cable Length	Cable	Safety Cut-out	Cable Colour	Nominal Current	Colour
<b>1</b>	1168430	10	3 m	H05VV-F 3G1,5		white	16 A	
	1165430	10	"	"		black	"	
	1168440	10	5 m	"		white	"	
	1165440	10	"	"		black	"	
<b>2</b>	1168460	5	10 m	H05VV-F 3G1,5		white	16 A	
	1167460	5	"	"		red	"	
	1165460	5	"	"		black	"	
	1167470	4	25 m	"		red	"	
	1165480	4	"	"		black	"	
	1167500	2	50 m	"		red	"	
	<b>3</b>	1109220	4	3 m	H05VV-F 3G1,5	•	black	16 A
1109230		4	"	"	•	"	"	black/blue
<b>4</b>	1092200	5	5 m	H05VV-F 3G1,5	•	"	"	black/light grey
	1093200	2	10 m	"	•	"	"	black/light grey
	1093230	2	"	"	•	"	"	black/blue/light grey
	1093270	2	"	"	•	"	"	black/bordeaux/light grey
	1094200	2	15 m	"	•	black	16 A	black/light grey
	1094270	2	"	"	•	"	"	black/bordeaux/light grey
	1092106	5	5 m	H05VV-F 3G1,0		"	10 A	black/blue
	1103466	2	10 m	"		"	"	black/blue
1102206	2	20 m	"		"	"	black/blue	



**1 Kistenmacher Cable Reels**  
with galvanized steel body



**2 Compact Cable Reels**  
portable and light

**brennenstuhl**



**3 Super Solid IP 20 Cable Reels**

**4 Garant® S4 Cable Reels**

**5 Garant® Cable Reels**



**6A Garant® CEE 1 Cable Reels**  
1 CEE-plug 400 V/16 A,  
2 water-jet protected sockets 230 V/16 A,  
1 CEE-socket 400 V/16 A:  
earthed sockets connected to separate phases



**7 Garant CEE 2 IP44 Cable Reels**  
CEE plug 230 V/16 A,  
2 CEE sockets 230 V/16 A



**8 Garant® G Garden Cable Reels**



**6B Garant® CEE 1 IP44 for Site & Industrie**

Art.No.	UP	Cable Length	Cable	Safety Cut-out	Cable Colour	Reel Ø mm	Reel Body	Self Closing Covers
<b>1</b> 1195067	1	50 m	H05VV-F 3G1,5	•	black	290	rust-resistant, galvanised sheet steel on a particularly sturdy frame	•
<b>2</b> 1079180004	4	15 m	"	•	black	180	special break-resistant Breflex plastic, galvanised frame - blue	•
1079220004	4	15 m	"	•	white	180	special break-resistant Breflex plastic, galvanised frame - white	•
<b>3</b> 1308810	1	15 m	"	•	black	180	special break-resistant Breflex plastic, galvanised frame	•
1308420	1	25 m	"	•	black	240	"	•
1308960	1	50 m	"	•	black	290	"	•
<b>4</b> 1195056	1	25 m	"	•	black	290	rust-resistant, galvanised sheet steel on a particularly sturdy frame	•
1195066	1	50 m	"	•	"	290	"	•
<b>5</b> 1208010	1		without cable			290	special break-resistant Breflex plastic, galvanised frame	•
1215056	1	25 m	H05VV-F 3G1,5	•	black	240	"	•
1205066	1	50 m	"	•	"	290	"	•
1208300	1	40 m	H05VV-F 3G2,5	•	"	290	" ... plus heavy duty cable	•
<b>6A</b> 1182730	1	30 m	H05VV-F 5G1,5	5-pin	black	290	special break-resistant Breflex plastic, galvanised frame	•
<b>6B</b> 1237990	1	20 m	H07RN-F 5G2,5	•	"	320	"	•
<b>7</b> 1182760	1	25 m	H05RR-F 3G2,5	•	black	290	"	•
1238073	1	40 m	"	•	black	320	"	•
<b>8</b> 1141740	1	25 m	H05W-F 3G1,5	•	red	240	"	•
1181750	1	50 m	"	•	"	290	"	•





# Bretec®-System

## Effortless winding, even with connected appliances

**Prevents cables from twisting and turning, and therefore prevents damage to connected cables.  
The reel turns, and the drum centre stays still.**

### The Problem:

Traditional cable reels turn the entire cable reel during reel in, and which inherently means the plug unit as well. This involves a dangerous interwoven turning of the power plug for the electric device, as well as laborious plugging and unplugging each time the reel is moved to a new location.

### The solution:

brennenstuhl® Garant with innovative **Bretec®** rotary contact comfort. While you turn the drum, the plug unit and the devices plugged into it remain in place. The path is clear for unimpeded, flexible, and safe work.

The one has got a Bretec;  
the other's got a mess.



- 1 Garant® Bretec® Schuko Cable Reels**  
with self closing covers, indicator shows overheating/overloading



- 2 Garant® Bretec® BS Cable Reels**  
with self closing covers  
**2A PVC body**  
**2B steel body**



	Art.No.	UP	Cable Length	Cable	Safety Cut-out	Cable Colour	Reel Ø mm	Voltage/ Nominal Current	Reel Body
<b>1</b>	<b>1208850</b>	1	25 m	<b>H05VV-F 3G1,5</b>	•	red	240	230 V/16 A	special break-resistant Breflex plastic, galvanised frame
	<b>1208860</b>	1	50 m	"	•	"	290	"	"
<b>2A</b>	<b>1208853</b>	1	25 m	"	•	red	240	240 V/13 A	special break-resistant Breflex plastic, galvanised frame
	<b>1208863</b>	1	50 m	"	•	"	290	"	"
<b>2B</b>	<b>1198867</b>	1	50 m	"	•	red	290	"	rust-resistant, galvanised sheet steel on a particularly sturdy frame

**brennenstuhl**



**1 Extension Cables 240 V**



**2 Extension Cables 240 V with 4-way power block**



**3 Extension Cables CEE 110 V**



**4 Vario Line Domestic Cable Reels** housing made of break-resistant plastic



**5 Comfort Line CL-S Cable Boxes**



**6 Compact Cable Reels AK 180**



**7 Cable Reels AK 260**

**8 Garant® Cable Reels** with self closing covers and cut-out



Art.No.	UP	Cable Length	Cable	Safety Cut-out	Cable Colour	Voltage/ Nominal Current	Colour	Sockets	Reel Body
<b>1A</b> 1166553	10	2 m	<b>H05VV-F 3G1,25</b>		white	240 V /13A		1	
1166563	10	3 m	"		white	"		1	
1166573	10	5 m	"		white	"		1	
<b>1B</b> 1166503	10	14 m	"		blue	"		1	
1166543	5	25 m	"		blue	"		1	
<b>2</b> 1168203	3	5 m	"		blue	"		4	
1168213	3	14 m	"		blue	"		4	
1166463	10	14 m	<b>H05VV-F 3G1,5</b>		yellow	110 V /16 A	—	3	
<b>3</b> 1098203	5	5 m	"	•	black	240 V/13 A	black/blue	3	
<b>4</b> 1108563	5	10 m	"	•	"	"	"	3	
1108903	5	15 m	"	•	"	"	"	3	
1108553	5	10 m	<b>H05VV-F 3G1,0</b>	•	"	"	black/grey	3	
1108203	5	20 m	"	•	"	"	"	3	
1109123	4	3 m	<b>H05VV-F 3G1,25</b>	-	black	240 V/13 A	black/white	3	
<b>5</b> 1078183004	4	15 m	<b>H05VV-F 3G1,5</b>	•	black	"			180 / special break-resistant Breflex plastic, galvanised frame
<b>6</b> 1098253001	1	25 m	<b>H05VV-F 3G1,25</b>	•	black	"			260 / break-resistant pvc, galvanised frame
<b>7</b> 1098403001	1	40 m	"	•	"	"			"
1218053	1	25 m	<b>H05VV-F 3G1,5</b>	•	black	240 V/13 A			240 / special break-resistant Breflex plastic, galvanised frame
<b>8</b> 1208063	1	50 m	"	•	"	"			290 / "
1208113	1	20 m	<b>H05VV-F 3G2,5</b>	•	"	"			240 / " ... plus heavy duty cable
1208123	1	40 m	"	•	"	"			290 / " ... plus heavy duty cable
1208013	1	---	without cable	•	---	---			290



**1 Kistenmacher Cable Reel BS**  
with galvanized steel body and self closing covers

**2 Garant® S3 Cable Reels**  
with self closing covers



**3 Super Solid S Cable Reel**  
extra stable steel tube frame with new, exclusive stability



**4 Garant® 110 V CEE 2 Cable Reels**



**5 Garant® CEE 2 IP44 Cable Reels**  
CEE plug 230 V/16 A,  
2 CEE sockets 230 V/16 A



**6 Super Solid Cable Reel**  
extra stable steel tube frame with new, exclusive stability



**7 Cable Reels AK 260 110 V CEE 2**



**8 Brobusta® Cable Reels**  
with self closing covers and cut-out



**9 Garant® Garden Cable Reels**  
for short-term use outdoors  
e.g. to operate lawnmowers, hedgecutters,  
electric trimmers, trimmers etc., when working on  
ladders or doing work with large radius



**brennenstuhl**

**10 Cable Reel - Promotion**



	Art.No.	UP	Cable Length	Cable	Safety Cut-out	Cable Colour	Reel Ø mm	Voltage/ Nominal Current	Reel Body
<b>1</b>	1198057	1	25 m	H05VV-F 3G1,5	•	black	290	240 V/13 A	rust-resistant, galvanised sheet steel
	1198067	1	50 m	"	•	"	290	"	"
<b>2</b>	1198053	1	25 m	"	•	black	240	240 V/13 A	"
	1198063	1	50 m	"	•	"	290	"	"
<b>3</b>	1309453	1	50 m	"	•	black	290	240 V/13 A	"
<b>4</b>	1148773	1	25 m	"	•	yellow	240	110 V/16 A	special break-resistant Breflex rubber, galvanised frame
	1138873	1	50 m	"	•	yellow	290	"	"
	1131953	1	25 m	H05VV-F 3G2,5	•	yellow	240	"	"
<b>5</b>	1182760	1	25 m	H05RR-F 3G2,5	•	black	290	230 V/16 A	special break-resistant Breflex plastic, galvanised frame
	1238073	1	40 m	H05RR-F 3G2,5	•	black	320	230 V/16 A	"
<b>6</b>	1308953	1	50 m	"	•	black	290	240 V/13 A	special break-resistant Breflex plastic, galvanised frame
<b>7</b>	1098743	1	25 m	"	•	yellow	260	110 V/16 A	break-resistant pvc, galvanised frame
	1098783	1	50 m	"	•	yellow	290	"	"
<b>8</b>	1311303	1	50 m	H05VV-F 3G1,5	•	black	290	240 V/13 A	steel-tube frame, galvanised & powder-coated
<b>9</b>	1141743	1	25 m	H05VV-F 3G1,5	•	red	240	240 V/13 A	special break-resistant Breflex plastic, galvanised frame
	1198033	1	20 m	H05WF-F 3G1,5	•	black	240	240 V/13 A	rust-resistant, galvanised sheet steel
<b>10</b>	1198043	1	40 m	H05WF-F 3G1,5	•	black	320	240 V/13 A	"

**1 Ex-Proof Rubber Handlamps**



**2 ISO Handlamps**



**3 Plastic Handlamps**



**4 Rubber Handlamps IP 20**



**5 Rubber Handlamps IP 5X**

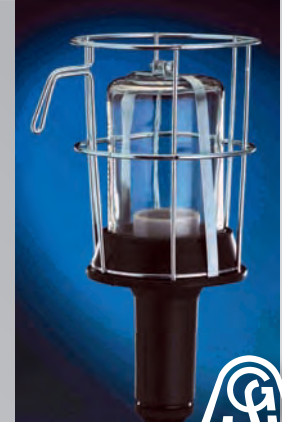

**6 Rubber-Handlamps IP 54**

stable, galvanized wire basket for heavy use, anti-dazzle screen



**7 Rubber Handlamps robust and handy**

wire basket with caps, protective glass cover



**brennenstuhl**

**8 Safety Inspection Lamps**

with impact-resistant, flexible basket



**BEST SELLER**

**9 Griplights**

heavy-duty inspection lamp with spring-loaded plastic grip handle and hanging hook

	Art.No.	Output Watt	Fittings	Extras	Art.No.	UP	Cable Length	Cable	Output Watt	Lamp Holder	Schuko-Plug	BS Plug	110 V Plug	Extras
<b>1</b>	439/GK	60	E 27	-	<b>6</b>	1176920	4	5 m	H07RN-F 2x1,0	60	E 27	•		
<b>2</b>	459	60	E 27	-	<b>7</b>	1176760	10	5 m	H05VV-F 2x0,75	60	E 27	•		
<b>3</b>	496	60	E 27	-		1176810	10	10 m	H05VV-F 2x0,75	60	E 27	•		
<b>4</b>	402	60	E 27	-		1176783	10	5 m	H05VV-F 2x0,75	100	E 27		•	
	402/WR	60	E 27	with rubber ring		1176893	4	5 m	H05VV-F 2x0,75	100	E 27			•
	472	100	E 27	-	<b>8</b>	1176026	10	5 m	H05VV-F 2x0,75	60	E 27	•		
	472/WR	100	E 27	with rubber ring		1176013	10	5 m	H05VV-F 2x0,75	60	E 27		•	
<b>5</b>	474	60	E 27	-	<b>9</b>	1176110	6	5 m	H05VV-F 2x0,75	60	E 27	•		
	474/WR	60	E 27	with rubber ring		1176113	6	5 m	H05VV-F 2x0,75	60	E 27		•	bulb included
	477	100	E 27	-		1176123	6	5 m	H05VV-F 2x0,75	60	E 27		•	bulb included
	477/WR	100	E 27	with rubber ring										

a. m. handlamps are supplied without cable





- 1 Inspection Lamps**
- 2 Car Inspection Lamps**  
with plug for cigarette lighters

- robust and impact-resistant
- ergonomically designed handle
- with electronic ballast in the handle
- hexagonal handle, prevents rolling away
- with large rotating hanging hook
- extremely low current consumption

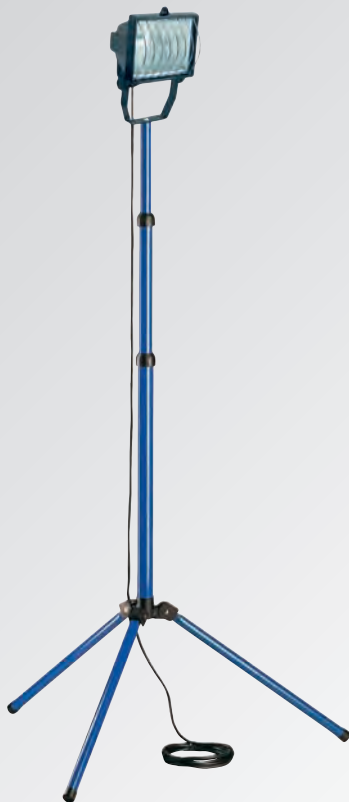

**3 Telescopic Tripods ST 200 IP 44**  
practical and suitable for outside use

the universal tripod made of powder-coated steel-tube, very stable, high quality, handy, reliable retaining nuts, universal tripod for use with halogens, restricted maximum permissible height

**4 28 LED Rechargeable Hand Lamps**  
Compact and handy

28 extra-bright LEDs, approx. 4-5 hours constant use when fully charged, no need to change bulb, rubber-clad housing, 360° hanging hook and magnet facility, on/off switch

**5 30 LED Batteries DL 30**  
Portable lamp with dynamo

option to charge the battery with integrated dynamo, 30 light intensity LED's, reversible to 6 or 30 LEDs, 360° adjustable hook and magnet, incl. 230 V and 12 V charger for car cigarette lighter, on/off switch



Art.No.	UP	Cable Length	Cable	Output Watt	Lamp Holder	Schuko-Plug	BS-Plug	110 V Plug	Measurements	Specifacion / Extras
<b>1</b> 1177100	10	5 m	H05VV-F 2x0,75	8		•			50 cm length appr.	
1177103	10	"	"	"			•		"	
1177130	10	"	"	"		•			54 cm length appr.	with bulb and on/off switch
<b>2</b> 1177060	10	5 m	H03VV H2-F 2x0,75	8						with bulb and with plug for cigarette lighters
<b>3</b> 1170750	1	5 m	H05RN-F 3x1,0	500	R 7s	•			telescopic up to 3 m	with bulb
1170753	1	"	"	"	"		•		"	"
1171753110	1	"	"	"	"			•	"	"
<b>4</b> 1175340	1	-	-	40		•			25 x 6 x 5 cm	inclusive 2 NI-MH batteries + charging unit
1175343	1	-	-	"			•		"	"
<b>5</b> 1178570	1	-	-	-		•			30 x 6 x 4 cm	-
1175373	1	-	-	-			•		"	-

**1 Eco-LED-light FL DUO**  
LED lamp with laser pointer – the absolute trendy item



**2 Eco-LED-light FL 135/8**  
LED lamp in a noble housing, very high light output, high efficiency through 2 batteries



**3 Eco-LED-light FL 220/4**  
slim, persistent LED torch, for durable usage and high efficiency



**4 Eco-LED-light FL 85/3**  
LED lamp in a noble housing for the trouser pocket, low power consumption, long battery life

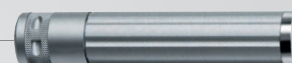

**5 Highlight LED 1**  
compact torch



**6 Highlight LED black**  
handy, small LED torch with an optical lens



**7 LuxPrimera LED Pen-Light**  
Handy flashlight for car, trade or hobby, with bright 0.5 Watt LED - LED lifetime: 11 years of permanent use „American Style“ ON/OFF switch at the end of the torch



**LuxPrimera LEDs**

with wrist strap and „American Style“ ON/OFF switch at the end of the torch dust-tight and protected against water-jets IP 65!

**8 LuxPrimera LED 100**  
equipped with 1 W power LED small enough to take everywhere



**9 LuxPrimera LED 120**  
high-performance 3 Watt LED flashlight with compact design, high range with 2 different settings, flashing function and soft-touch-function



**10 LuxPrimera LED 140**  
ultra bright 3 Watt LED light, very long range with 2 different settings, flashing function and soft-touch-function



**11 LuxPrimera LED 145 Multicolor**  
equipped with 1 W power LED 3 different settings: white - red - green with soft-touch-function



Art.No.	UP	LEDs	Battery Type	Demension Appr. mm	Ø mm	Housing	Specifications
<b>1</b>	<b>1179890</b>	3	8	3 x AAA	110	28	handy metal soft-touch switch with 2 functions: 1. LEDs on, 2. laser pointer on
<b>2</b>	<b>1179870</b>	3	8	2 x AA	140	23	brushed aluminium design
<b>3</b>	<b>1179700</b>	6	4	3 x AA	220	18	solid high quality aluminium with carrying ring and protective lens
<b>4</b>	<b>1179880</b>	6	3	1 x AAA	85	16	brushed aluminium design
<b>5</b>	<b>1178420</b>	1	1	4 x AG 13	85	30	rubberised handle, rotating key-ring, twist-switch in the head of the torch, waterproof
<b>6</b>	<b>1178430</b>	1	1	4 x AG 3	75	20	twist-switch in the head of the torch, with key-ring
<b>7</b>	<b>1175970</b>	1	1	1 x AAA			strong and sturdy aluminium incl. one standart battery AAA type
<b>8</b>	<b>1178700</b>	1	1 Watt	1 x AA	105	30	elegant, robust aluminium incl. one standart battery AA type
<b>9</b>	<b>1178710</b>	1	3 Watt	3 x AAA	120	36	elegant, robust aluminium incl. three standart battery AAA type
<b>10</b>	<b>1178720</b>	1	3 Watt	3 x AAA	140	35	elegant, robust aluminium incl. three standart battery AAA type
<b>11</b>	<b>1178730</b>	1	3 Watt	3 x AAA	150	35	elegant, robust aluminium incl. three standart battery AAA type

**1178706** without battery  
**1178716** without battery  
**1178726** without battery  
**1178736** without battery



### 1 Lux Primera Focus 100 LED

Extreme bright LED torch (CREE technology),  
100lm - 97mm x dia. 25mm, 1 Watt LED, UP: 1  
Art.No. [1178740](#) with 3 x AA battery  
Art.No. [1178746](#) without battery



### 1 Lux Primera Focus 150 LED

Extreme bright LED torch (CREE technology),  
150lm - 110mm x dia. 30mm, 5 Watt LED, UP: 1  
Art.No. [1178750](#) with 3 x AAA battery  
Art.No. [1178756](#) without battery



### 2 LED Head-Light HL 10

10 LEDs, practical, adjustable headlight,  
UP: 2, focus angle can be adjusted,  
pushbutton ON/OFF (changeover) switch,  
waterproof, packing blister  
Art.No. [1179770](#) with 3 x AAA battery  
Art.No. [1179776](#) without battery



**1 Watt LED,  
one of the brightest  
LEDs in the world.**

### 3 LED Head-Lights HL 2in1

can be used as a forehead lamp and bicycle lamp,  
1 Watt LED with high luminance, UP: 2,  
3 switching levels and flashing function,  
with headband and handlebar attachment  
robust ABS housing, packing blister  
Art.No. [1179860](#) with 3 x AAA battery  
Art.No. [1179866](#) without battery



### 5 PMR Walkie Talkies TRX 3000

free communication up to a distance of 5 km, easy to use, small, handy and robust,  
LC display with background lighting, eight channels with automatic channel search,  
four ring tones, Roger Beep, automatic noise suppressor, port for headphones/microphone,  
battery monitoring, eight AAA batteries required per set (batteries not included)

Art.No. [1290900](#)



**BEST  
SELLER**

- 1 KISTENMACHER brand Emty Tool Boxes**  
made of sheet metal, hammer slag blue, with hole for locking
- 1A 3-tray with 1 handle**
  - 1B 5-tray with 1 handle**
  - 1C 3-tray with 2 handle**
  - 1D 5-tray with 2 handle**
  - 1E 7-tray with 2 handle**



- 2 Workshop Trolleys**  
**load capacity: 150 kg**
- colour: blue - other colours on request  
drawers made of strong metal sheet with partitions  
lockable drawers with central locking system  
rubber coated top  
metal body powder coated  
mobile unit with 4 strong wheels (2 x swivel – 2 x fixed)
- 2A 1 + 4 drawers big**  
trolley with 4 drawers + 1 storage compartment extractable on both sides and one extra big compartment – (easy storage for big tools)
  - 2B 6 drawers**  
trolley with 6 full extractable drawers on one side only

- 3 Cases for Electric Tools**  
Size 401 x 352 x 156 mm  
Art.No. 143007



	Size mm	Art.No.
<b>1A</b>	430 x 200 x 160	430/3-1
	530 x 200 x 160	530/3-1
<b>1B</b>	430 x 200 x 200	430/5-1
	530 x 200 x 200	530/5-1
<b>1C</b>	430 x 200 x 160	430/3-2
	530 x 200 x 160	530/3-2
<b>1D</b>	430 x 200 x 200	430/5-2
	530 x 200 x 200	530/5-2
<b>1E</b>	430 x 200 x 250	430/7-2
	530 x 200 x 250	530/7-2
<b>2A</b>	750 x 400 x 870	WST-5
<b>2B</b>	750 x 400 x 910	WST-6



- 4 Tool Pouches** made from real leather
- 4A professional simple tool pouch**  
Art.No. 091001
  - 4B professional double tool pouch**  
Art.No. 092008

- 1 Model 21/22/24**  
box: blue / tray: red



- 2 Model 23/25**  
box: blue / tray: red / extra box: transparent



- 3 Model 9/10**  
**3A** box: blue / without tray  
**3B** box: blue / with tray



- 4 Model 11/12**  
box: blue / tray: red / plastic locks



- 5 Model 15/17**  
box: blue / tray: red / metallic locks



- 6 Model 16/18**  
box: blue / tray: red / extra tray: red / metallic locks



- 7 Model 30/32/34-1B**  
box: grey / tray: red



- 8 Model 31/33/34**  
box: grey / tray: red / extra box: red



- 9 Model 35**  
box: grey / 2 trays: red / extra box: red



## 10 Carrying Straps

Art.No. 149009



	Size mm	Art.No.	Model No.
<b>1</b>	310 x 160 x 130	121005	21
	356 x 184 x 163	122002	22
	400 x 206 x 188	124006	24
<b>2</b>	356 x 184 x 163	123009	23
	400 x 206 x 188	125003	25
<b>3A</b>	290 x 170 x 127	109003	9
<b>3B</b>	290 x 170 x 127	110009	10
<b>4</b>	356 x 192 x 150	111006	11
	400 x 217 x 166	112003	12
<b>5</b>	500 x 258 x 255	115004	15
	580 x 290 x 290	117008	17
<b>6</b>	500 x 258 x 255	116001	16
	580 x 290 x 290	118005	18
<b>7</b>	445 x 235 x 230	130007	30
	480 x 258 x 255	132001	32
	580 x 285 x 290	134999	34-1B
<b>8</b>	445 x 235 x 230	131004	31
	480 x 258 x 255	133008	33
	580 x 285 x 290	134005	34
<b>9</b>	580 x 285 x 290	135002	35

**1A Model 400/450**  
 box: black / tray: red  
 with aluminium handle  
 and metallic locks



**1B Model 500/600**  
 box: black / tray: red  
 with aluminium handle  
 and metallic locks



**2 Tool Chests Model 56**  
 box: black / cover: blue  
 without tray



**3 Mobile Tool Chests Model 50/53**  
 box: black / cover: blue  
 with 2 extra trays: red  
 with 2 wheels and strong handle



**4 Mobile Tool Chests Model 51/54**  
 box: black / cover: blue  
 with 2 extra trays: red / 2 extra boxes: red  
 with 2 wheels and strong handle



**5 Mobile Trail Boxes Model 57**  
 box: black / cover: black  
 with tray: red  
 with plastic locks / wheels and strong handle

**6 Mobile Trail Boxes Model 58**  
 box: black / cover: black  
 with tray: red / extra box: transparent  
 with metallic locks / wheels and strong handle



	Size mm	Art.No.	Model No.
1A	400 x 225 x 190	162008	400
	450 x 285 x 250	163005	450
1B	500 x 295 x 270	165009	500
	600 x 305 x 295	167003	600
2	740 x 472 x 493	156007	56
3	675 x 472 x 416	150005	50
	775 x 472 x 493	153006	53
4	675 x 472 x 416	151002	51
	775 x 472 x 493	154003	54
5	470 x 290 x 630	157004	57
6	470 x 290 x 630	158001	58

## 1 Pioneer Pipe Vice Stands

universal stand-mounted steel pipe vice with hardened steel jaws, stable floor, easily transportable and ready set up and varnished body, red colour range: 1/4" - 3"

Art.No. **Pioneer 03**



## 2 Mechanical Rack Jacks

with safety crank, blue lacquered



## 3 Rope Hoist Type 30

blue lacquered, incl. steel rope with hook (packed separately)



## 4 Lever Jacks

with link chain, Type "RZC", 1.5 m lifting

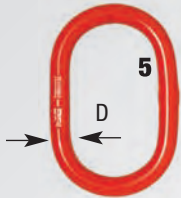

## 5 Oblong Master Links TWN 0831

for single leg slings, red

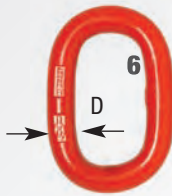

## 6 Oblong Master Links TWN 0832

for double leg slings, red

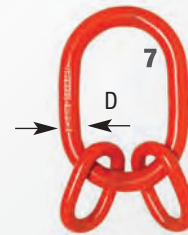

## 7 Master Link Assemblies TWN 0833

for 3- and 4-leg slings, red

Capacity (ton)	Rope Length (m)	Art.No.	Trade Size (mm)	D (mm)	Working Load (ton)	Art.No.	Trade Size (mm)	D (mm)	Working Load (ton)	Art.No.			
<b>2</b>	<b>2.5</b>	-	<b>15-00/2.5</b>	<b>5</b>	<b>6 - 8</b>	13	1.12	<b>F12008</b>	<b>7</b>	<b>6 - 8</b>	18	2.36	<b>F12342</b>
	<b>5.0</b>	-	<b>15-00/5</b>		<b>8 - 8</b>	16	2.00	<b>F12012</b>		<b>8 - 8</b>	22	4.25	<b>F12354</b>
	<b>10</b>	-	<b>15-01/10</b>		<b>10 - 8</b>	18	3.15	<b>F12018</b>		<b>10 - 8</b>	26	6.7	<b>F12362</b>
	<b>16</b>	-	<b>15-01/16</b>		<b>13 - 8</b>	22	5.3	<b>F12034</b>		<b>13 - 8</b>	32	11.2	<b>F12398</b>
	<b>20</b>	-	<b>Z23</b>		<b>16 - 8</b>	26	8.0	<b>F12052</b>		<b>16 - 8</b>	36	17.0	<b>F12422</b>
<b>3</b>	<b>0.8</b>	20	<b>30-10/20</b>	<b>18 - 8</b>	32	10.0	<b>F12094</b>	<b>18 - 8</b>	45	21.2	<b>F12452</b>		
	<b>0.8</b>	40	<b>30-10/40</b>	<b>20 - 8</b>	36	12.5	<b>F12116</b>	<b>20 - 8</b>	50	26.5	<b>F12468</b>		
	-	w/o rope	<b>30-10</b>	<b>22 - 8</b>	36	15.0	<b>F12120</b>	<b>22 - 8</b>	50	31.5	<b>F12472</b>		
	<b>1.6</b>	20	<b>30-00/20</b>	<b>26 - 8</b>	45	21.2	<b>F12168</b>	<b>26 - 8</b>	56	45.0	<b>F12482</b>		
	<b>1.6</b>	40	<b>30-00/40</b>	<b>28 - 8</b>	45	25.0	<b>F12172</b>	<b>28 - 8</b>	63	50.0	<b>F12488</b>		
	-	w/o rope	<b>30-00</b>	<b>32 - 8</b>	50	31.5	<b>F12198</b>	<b>32 - 8</b>	71	67.0	<b>F12492</b>		
	<b>3.2</b>	20	<b>30-11/20</b>	<b>36 - 8</b>	56	40.0	<b>F12226</b>	<b>36 - 8</b>	80	85.0	<b>F12498</b>		
	<b>3.2</b>	40	<b>30-11/40</b>	<b>40 - 8</b>	63	50.0	<b>F12244</b>	<b>40 - 8</b>	90	106.0	<b>F12502</b>		
	-	w/o rope	<b>30-11</b>	<b>6</b>	<b>6 - 8</b>	13	1.6	<b>F12014</b>	<b>6 - 8</b>	18	2.8	<b>F12020</b>	
	<b>4</b>	<b>0.8</b>	-		<b>RZC0.8</b>	<b>8 - 8</b>	18	2.8	<b>F12020</b>	<b>10 - 8</b>	22	4.25	<b>F12036</b>
<b>1.6</b>		-	<b>RZC1.6</b>		<b>10 - 8</b>	22	4.25	<b>F12036</b>	<b>13 - 8</b>	26	7.5	<b>F12054</b>	
<b>3.2</b>		-	<b>RZC3.2</b>		<b>13 - 8</b>	26	7.5	<b>F12054</b>	<b>16 - 8</b>	32	11.2	<b>F12096</b>	
<b>5.0</b>		-	<b>RZC5.0</b>		<b>16 - 8</b>	32	11.2	<b>F12096</b>	<b>18 - 8</b>	36	14.0	<b>F12118</b>	
					<b>18 - 8</b>	36	14.0	<b>F12118</b>	<b>20 - 8</b>	40	17.0	<b>F12152</b>	
			<b>20 - 8</b>		40	17.0	<b>F12152</b>	<b>22 - 8</b>	45	21.2	<b>F12170</b>		
			<b>22 - 8</b>		45	21.2	<b>F12170</b>	<b>26 - 8</b>	50	30.0	<b>F12200</b>		
			<b>26 - 8</b>		50	30.0	<b>F12200</b>	<b>28 - 8</b>	50	33.5	<b>F12202</b>		
			<b>28 - 8</b>		50	33.5	<b>F12202</b>	<b>32 - 8</b>	56	45.0	<b>F12228</b>		
			<b>32 - 8</b>	56	45.0	<b>F12228</b>	<b>36 - 8</b>	63	56.0	<b>F12246</b>			
			<b>36 - 8</b>	63	56.0	<b>F12246</b>	<b>40 - 8</b>	71	71.0	<b>F12250</b>			





## 1 Volt Check 3.1 IP 40

Range AC/DC	6-400 V
Specifications	LED
Art.No.	991895



## 2 Master Check IP 65, battery powered

Range AC/DC	6-400 V
Specifications	LED
Art.No.	991888



## 3 Combi Check IP 65, battery powered

Range AC/DC	6-690 V
Specifications	LED
Art.No.	991886



## 4 Combi Check Pro IP 65, battery powered

Range AC/DC	6-690 V
Specifications	LED
Art.No.	127933



## 5 Multi Check IP 65, battery powered

Range AC/DC	5-500 V
Specifications	LCD
Art.No.	991892



## 6 Digi Check IP 65, battery powered

Range AC/DC	5-690 V
Specifications	LCD
Art.No.	991885



## 7 Digi Check Pro IP 65, battery powered

Range AC/DC	5-690 V
Specifications	LCD
Art.No.	991887



**Weidmüller** 



## 9 Moisture Detectors MD

- To determine the moisture content of wood building material, such as, e.g. concrete, brick, screed, plasterboard, wallpaper, etc.
- Measurement range of 5 - 50 % for wood, or 1.5 - 33 % for building material
- Display on a large LCD display (in percent, resolution 0.1 %) as well as acoustically (can be deactivated)
- Practical „hold“ function also makes measurement possible at locations difficult to access
- Automatic switch-off approx. 3 mins, after last application
- Battery low voltage display
- Robust, ergonomic housing with separate compartment for 9 V monobloc battery (not included)
- With protective cap

Art.No. **1298680**



## 10 Multi Function Detectors WMV Plus Metal/voltage/beam detector

- For locating metal, voltage-carrying cables (AC voltage) and wooden beams, e.g. in walls
- 3 functions on one appliances, functions can be individually applied
- Accurate display of the measurement result on a large LCD display (numerical and by bar charts) as well as acoustically
- Automatic sensitivity control
- Automatic switch-off after end of the measurement
- Battery low voltage display
- Battery compartment for 9 V block (delivered without battery)
- User friendly through the operating button on the side and front. Ergonomic design
- Maximum detection: wood up to 40 mm, AC voltage approx. 30-50 mm, metal approx. 50-80 mm

Art.No. **1298180**



**1 Electronic Multi Testers MT 6 S/2**

- Non-contact location of cables with AC voltage
- Checking phase, neutral and earthing conductor at the sockets
- Continuity and Polarity check, e.g. of fuses, bulbs, etc
- Display through the LED
- Due to super-bright LED, can also be used as a torch
- Inclusive 3 replaceable coin cells, blister packing

Art.No. **1297150**

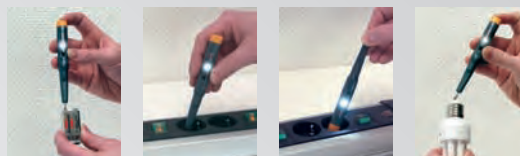

**2 Voltage Testers 100 - 500 V**

**2A clear - plastic cap and clip**

**2B clear - brass cap and clip**

**2C clear - brass cap**

**2D yellow - plastic cap and clip**

**2E yellow - brass cap and clip**

**2F yellow - brass cap**



**3 Euro Voltage Testers 125 - 250 V**

**3A red with plastic clip**

**3B blue with plastic clip**

**3C orange with plastic clip**



**4 Car Light Testers**

with cable and crocodile clip  
120 mm, 6 - 24 V

**4A plastic version - yellow**

Art.No. **4568 A**

**4B brass version**

Art.No. **4598 A**



**5 Spark Plug Testers**

120 mm, 6 - 24V, yellow

Art.No. **4568 Z**



**6 Car Light + Spark Plug Tester Sets**

with cable and crocodile clip, in single plastic wallets  
120 mm, 6 - 24 V, plastic version, yellow  
including 4568A + 4568Z

Art.No. **4518 ZA/T**

**7 Radio Screwdrivers Sets**

display stand consisting of:

20 pcs - 60 mm blade - yellow handle

20 pcs - 80 mm blade - blue handle

20 pcs - 40 mm blade - red handle

Art.No. **900**



**8 SECUPEN Voltage Testers 100-250 V**

**8A with clip hanger**

**8B without clip hanger in display box packing**

**8C without clip hanger in bulk packing**



Size (mm)	2A Art.No.	2B Art.No.	2C Art.No.	2D Art.No.	2E Art.No.	2F Art.No.
<b>125</b>	451 P/k	451 PM/k		451 P/g	451 PM/g	
<b>140</b>	452 P/k	452 PM/k		452 P/g	452 PM/g	
<b>190</b>			457 PM/k			457 PM/g

Size (mm)	packing unit	8A Art.No.	8B pcs/box Art.No.	8C pcs/box Art.No.
<b>137</b>	1000	17150A/C	40 17150A/D	400 17150A/B
<b>215</b>	400	17151/C	40 17151/D	600 17151/B





### Spirit Levels Type 70, 70-2, 70 M

Traditional aluminium spirit level with smooth sides, electrostatic powder coating - the ideal all round level for household, DIY and professional use

- yellow powder coated, light metal rectangular profile
- measurement accuracy: in the normal position  $0.029^\circ = 0.5 \text{ mm/m}$



- Type 70**  
with 1 vertical and 1 horizontal vial
- Type 70-2**  
with 2 vertical and 1 horizontal vials
- Type 70 M**  
with 1 vertical and 1 horizontal vial plus strong magnets.  
1, 2, 4 or 6 magnets, depending on the length



### Spirit Levels Type 80 E, 80 E-2

Traditional spirit level with smooth sides, electrostatic powder coating, anodised colour

- silver anodised, light metal rectangular profile
- measurement accuracy: in the normal position  $0.029^\circ = 0.5 \text{ mm/m}$



- Type 80 E**  
with 1 vertical and 1 horizontal vial
- Type 80 E-2**  
with 2 vertical and 1 horizontal vials

### Spirit Levels Type 80 A, 80 A-2, 80 AM

This spirit level can be used **to check the horizontality of overhead surfaces** by turning it and its horizontal vial upside down. In this so-called “transfer” position, you can then measure precisely from underneath. The ribbed light metal rectangular profile ensures a secure grip when using work gloves.

- yellow powder coated **with milled measuring surface**
- measurement accuracy: in the normal position  $0.029^\circ = 0.5 \text{ mm/m}$   
for overhead measurements:  $0.043^\circ = 0.75 \text{ mm/m}$



- Type 80 A**  
with 1 vertical and 1 horizontal vial
- Type 80 A-2**  
with 2 vertical and 1 horizontal vials
- Type 80 AM**  
with 1 vertical and 1 horizontal vial plus super powerfull rare earth magnets 2 or 4, depending on the length



Length (cm)	1 Art.No.	2 Art.No.	3 Magnets Art.No.	4 Art.No.	5 Art.No.	6 Art.No.	7 Art.No.	8 Magnets Art.No.
30	7030	–	1 70M/30	80E/30	80E-2/30	80A/30	–	–
40	7040	70240	2 70M/40	80E/40	80E-2/40	80A/40	80A-2/40	2 80AM/40
45	7045	70245	–	–	–	–	–	–
50	7050	70250	2 70M/50	80E/50	80E-2/50	80A/50	–	–
60	7060	70260	2 70M/60	80E/60	80E-2/60	80A/60	80A-2/60	2 80AM/60
80	7080	70280	2 70M/80	80E/80	80E-2/80	80A/80	80A-2/80	2 80AM/80
90	7090	70290	–	–	–	–	80A-2/90	–
100	70100	702100	4 70M/100	80E/100	80E-2/100	80A/100	80A-2/100	2 80AM/100
120	70120	702120	4 70M/120	80E/120	80E-2/120	80A/120	80A-2/120	2 80AM/120
150	70150	702150	4 70M/150	80E/150	80E-2/150	–	80A-2/150	4 80AM/150
180	70180	702180	6 70M/180	80E/180	80E-2/180	–	80A-2/180	4 80AM/180
200	70200	–	6 70M/200	80E/200	80E-2/200	–	80A-2/200	4 80AM/200



**1 Type 80 A electronic**

combines the advantages of the Type 80 A with electronic measuring technology and digital display, with 30 cm long ideal tool-bag format, audible inclination guide with three different signals, easy to read digital display rotates for overhead measurement, protection against dust and water splashes from any direction in accordance with IP 54  
 measurement accuracy: in the normal position = 0.5 mm/m  
 for overhead measurements: = 0.75 mm/m  
**length 30 cm**

Art.No. [80A electronic 17323](#)



**2 Type 81SM Torpedo**

strong cast aluminium level with T profile, easy to hold, particularly slender trapezoidal shape, with 2 x strong rare earth magnet, with belt pouch with 1 vertical and 1 horizontal vial  
 measurement accuracy: in the normal position = 0.5 mm/m  
 for overhead measurements: = 0.75 mm/m  
**length 25 cm**

Art.No. [81SM torpedo 02511](#)



**Aluminium Spirit Level Type 70 T, 70 TM**

with 1 horizontal and 1 vertical vial - yellow powder coated, the vials are firmly secured in the strong light metal profile - this spirit level is so handy that you can carry it around with you all the time  
 measurement accuracy: in the normal position  $0.029^\circ = 0.5 \text{ mm/m}$

- 3 Type 70 T without magnet length 25 cm** Art.No. [70T/25](#)
- 4 Type 70 TM with strong magnetic strip length 22 cm** Art.No. [70TM/22](#)



**5 Type AWM Digital Protractor**

precise angle measuring facility with built-in digital display - smooth aluminium rectangular profile - measuring range  $180^\circ$   
 with 1 vertical and 1 horizontal vial - on/off switch, **length 34 cm**

Art.No. [AWM 17142](#)



**6 Type 70 MAS Marking Spirit Levels**

smooth rectangular aluminium profile - with 1 vertical and 1 horizontal vial, the distance needed between drill holes is set on the spirit level with the aid of a sliding marker, the positions of the drill holes can be transferred with spot-on accuracy, with 2 x scales (mm): one end-to-end scale and one starting at the centre, **length 80 cm**

Art.No. [70MAS 1411/0](#)



## STABILA®



### 1 Pocket Spirit Levels

genuine precision vial firmly cast into position for aligning units and fixtures, for inaccessible places, with belt clip and single packing or optionally with counter display presentation, **width x height: 2 x 4 cm**

#### 1A Pocket Basic

plastic mini-format spirit level for horizontal measurements

Art.No. [PB 18114](#)

#### 1B Pocket Magnetic

plastic mini-format magnetic spirit level, ideal for aligning and adjusting metal objects, for horizontal measurements

Art.No. [PM 18116](#)

#### 1c Pocket Magnetic Pro

plastic spirit level with robust aluminium core case, with 2 x extra strong rare earth magnets, frame with two precision-milled (measuring surfaces for horizontal and vertical measurements)

Art.No. [PMP 17953](#)



1A



1B



1c

### 2 LAX 50

self-levelling crossed line laser, including combined tripod/ telescopic leg kit for the installation of built-in furniture, laying tiles, wall-papering and all installation work - setting out without a single pencil mark that's clean working!

Laser Class 2, range 10 m

Art.No. [LAX 50](#)



### 3 LAX 200

self-levelling crossed line laser, ultra-sharp, long laser lines, belt pouch and strong rare earth magnet for fixing to metal brackets etc., casing in U-shaped holder can be rotated through 360°, complete room can be scanned, ideal for inside work.

Laser Class 2, range 20 m

Art.No. [LAX 200](#)



### 4 LT 30

telescopic laser support, variable positioning of lasers at a required working height, from 20 to 365 cm, includes laser platform, transportation length: 135 cm

Art.No. [18238](#)



**STABILA®**

**1 OLS 26 Set**
**a) optical level**

easy to read and reliable transfer of heights. 26x magnification in the optical system, strong carrying case, easy-to-grip, impactabsorbing soft-grip cover, protection class IP 54 set does not require batteries

**b) aluminium levelling rod**

(T-NL), aluminium (anodised), extendable up to 500 cm; long-distance visible scale with 'E' gradations; reverse side with 'cm' gradations

**c) flat-headed construction tripod**

aluminium, rapid locking and spread stopper with high quality chain - (BST-S) height: 100 - 160 cm

Art.No. **18460**

**2 ZP-M**

laser target plate (coated) with rule providing optimum reflection for ease of work even in daylight and over long distances

Art.No. **07428**

**3 Folding Rules Type 900**

the approx. 2.8 mm thick beech sections are connected by sprung jointing plates, black graduation scale with red tens is clearly and evenly printed, length 2 m

**white/yellow** Art.No. **1624/1**

**yellow** Art.No. **1604/3**

**white** Art.No. **1634/0**





## STABILA®



### STABILA Laser Distance Measures

ideal for all craftsmen working, robust, impact-resistant casing with shock-absorbent softgrip cover

#### 1 LD 320

- compact class / 8 functions
- **40 m range** of visible laser line (with reflector plate to 50 m)
- red laser diode - large figures and illuminated display
- protection class IP40
- battery life (2 x AAA included) up to 3.000 measurements
- with belt pouch for easy carrying

Art.No. **18379**



#### 2 LD 420

- measuring genius with 13 functions
- **80 m range** of visible laser line (with reflector plate to 100 m)
- red laser diode
- with integrated calculation functions
- protected against water and dust in accordance with IP 65
- battery life (2 x AAA included) up to 5.000 measurements
- with belt pouch for easy carrying

Art.No. **18378**



#### 3 LD 520

- digital target locator using a built-in camera with crosshairs
- 4x zoom - 2.4" colour display
- **200 m working range**
- high contrast colour display
- 360° inclination sensor for complete flexibility
- comprehensive package of 18 measuring functions
- Bluetooth Smart 4.0 for data transfer (free app available)
- integrated calculator
- control buttons can be assigned individually
- maximum precision even over long distance
- protection class IP 54 (rain/dust)
- battery life (2 x AA included) up to 5.000 measurements
- with belt pouch for easy carrying

Art.No. **18562**



#### 4 Architect's Tape Measures

smallest measuring tape - extremely durable light-weight polyamide casing with only 75 mm in diameter - nickelplated spring-loaded crank - high quality measuring instrument with a touch of exclusivity - white-painted steel blade, cm and mm graduation, width 10 mm

Art.No. **10642** Length 10 m

Art.No. **10565** Length 15 m



#### 5 Open-Frame Tape Measures BM 42

impact-resistant, unbreakable polyamide frame with reinforcement ribs on the inside, with turning handle, well-proven Y design, large, robust draw ring with notches for plumbline measurements, width 13 mm

**5A** fibreglass measuring tape (white), standard scale: cm = gradation in cm one side only, first metre in mm

**5B** white-painted steel measuring tapes, standard scale: mm = full length gradation in mm, one side only

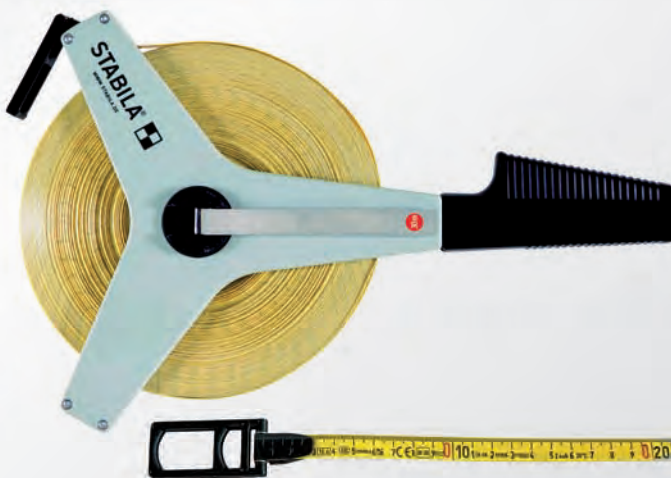

Length (m)	5A Art.No.	5B Art.No.
30	10589	10706
50	10596	10711
100	-	10721

# STABILA®

**1 Pocket Tape Measures Type BM 40 - professional**  
 shatter-proof plastic case with shock-absorbent softgrip cover  
 - excellent impact resistance - secure belt clip - patented  
 STABILA hook with non slip-spikes - push brake for the 3 and  
 5 m length models - rocker brake for models with 8 and 10 m  
 long blades - measuring scale with superb abrasion  
 resistance provided by a high-performance polyester coating

- 1A single scale mm/cm
- 1B double scale mm/ft



**2 Pocket Tape Measures Type BM 30**

casing made of unbreakable plastic with belt clip, patented STABILA hook  
 with non slip-spikes, stopper for braking and locking the blade,  
 polyamide-coated (curved) yellow steel blade (with high abrasion resistance)

- 2A single scale mm/cm
- 2B double scale mm/ft



**3 Cased Tape Measures BM 50**

impact-resistant nylon casing, optimal handling thanks to the retractable re-wind drum,  
 special hook with a spike coating, new eyelet for quickreleasefixing

- 3A fibreglass measuring tape (white),  
 standard scale: cm = gradation in cm  
 one side only, first metre in mm
- 3B white-painted steel measuring tapes,  
 standard scale: mm = full length gradation in mm,  
 one side only

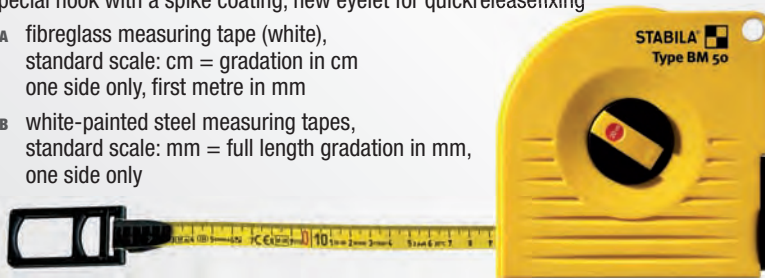

**4 KNIGHT Pocket Tape Measures**

blade made of carbon steel,  
 thickness of tape blade: 0.115 mm,  
 length available up to 10 m



**4A Type MKA**  
 tape measure in strong  
 ABS case with carrying  
 strip, colour: blue/white  
 and white blue

**4B Type RGA**  
 tape measure  
 in rubber coated  
 strong ABS case,  
 colour: rey/black



Length (m)	Width (mm)	1A Art.No.	2A Art.No.	Length (m/ft)	3A Art.No.	Length (m/ft)	Width (mm)	4A Art.No.	4B Art.No.
2	13	-	16449	10	17214	2/6	13	EGK MKA2013	EGK RGA2013
3	16	17736	16450	20	17215	3/10	13	EGK MKA3013	EGK RGA3013
5	19	17740	16451	30	17216	3.6/12	13	EGK MKA3613	EGK RGA3613
5		17744				3/10	16	-	EGK RGA3016
8	25	17745	16452			3/10	19	EGK MKA3019	EGK RGA3019
10	27	17747		10	17220	5/16	19	EGK MKA5019	EGK RGA5019
				20	17221	5/16	25	EGK MKA5025	EGK RGA5025
		1B	2B	30	17222	5.5/18	25	EGK MKA5525	EGK RGA5525
2	13	-	-			7.5/25	25	EGK MKA7525	EGK RGA7525
3	16	17737	16453			8/27	25	EGK MKA8025	EGK RGA8025
5	19	17741	16454			9/30	25	EGK MKA9025	EGK RGA9025
8	25	17746	16455			10/33	25	EGK MKA1025	EGK RGA1025
10	27	17748	-			7.5/25	28	-	EGK RGA7528



**All Measuring Tapes:** width: 13 mm, with 2 measures, measure start 'C'

**optional measurement commencements:**

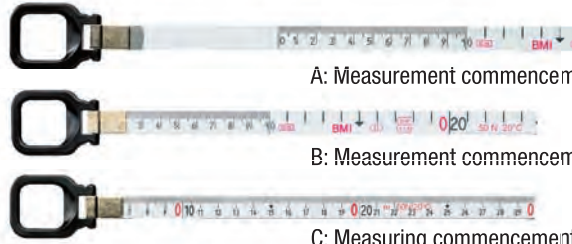
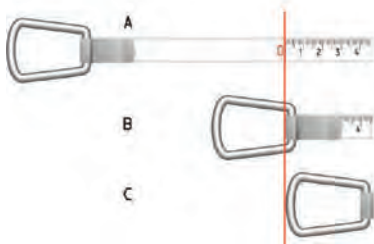

A: Measurement commencement approx. 10 cm after end fitting

B: Measurement commencement at front fitting edge

C: Measuring commencement at front ring edge



**WEISS brand Measuring Tapes 1-3**

in steel case with artificial leather coating, steel fittings nickel plated

**1 Fibreglass white**  
1A cm/inch 1B mm/inch

**2 Steel white enamelled**  
2A cm/inch 2B mm/inch

**3 Steel yellow enamelled**  
3A cm/inch 3B mm/inch

**WEISS brand Steel Measuring Tapes 4-7**

white enamelled, with black plastic handle and steel nickel plated crank

**4 TYPE 600** angular  
on anodized aluminium frame,  
graduation cm/inch

**5 TYPE 700** straight  
on anodized aluminium frame,  
graduation cm/inch

**6 TYPE 900** angular  
on anodized aluminium  
triangle frame,  
graduation cm/inch

**7 TYPE 800** straight  
on anodized aluminium  
triangle frame,  
graduation cm/inch



**BMI brand Steel Measuring Tapes** white enamelled, on anodized aluminium frame with black plastic handle  
popular graduations available: Art.No. **3**: cm-inch, Art.No. **5**: mm-inch

**8 No. 1000**

**9 No. 2000**



	1A	1B	2A	2B	3A	3B	4	5	6	7	8	9
Length (m)	Art.No. 287 GL/...	Art.No. 287 GLM/...	Art.No. 208 WE/...	Art.No. 208 WEM/...	Art.No. 208 GE/...	Art.No. 208 GEM/...	Art.No. 621 WE/...	Art.No. 721 WE/...	Art.No. 921 WE/...	Art.No. 821 WE/...	Art.No. 5010...	Art.No. 5010...
5	5	5	5	5	5	5	5	5	—	—	—	—
10	10	10	10	10	10	10	10	10	10	10	13010C	—
15	15	15	15	15	15	15	15	15	15	15	13015C	—
20	20	20	20	20	20	20	20	20	20	20	13020C	—
25	25	25	25	25	25	25	25	25	25	25	13025C	—
30	30	30	30	30	30	30	30	30	30	30	13030C	—
40	40	40	40	40	40	40	40	40	40	40	—	—
50	50	50	50	50	50	50	50	50	50	50	13050C	33050C
100	—	—	—	—	—	—	—	—	100	100	—	43100C

**1 Road Measuring Wheels**

handle foldable, capacity: 9.999.99 m 1 cm reading, wheel diameter 318.5 mm = 1 m circumference, subtracts and adds, weight: 3900 g

**1A** tolerance below 0,05%, built in stand, colour: orange enamelled

Art.No. **1200 2001**

**1B** tolerance below 0,02 %, built in stand, TÜV-approved and suitable for calibration, colour: luminous red paint (w/o picture)

Art.No. **1200 0001**

**1c Transport Case**

imitation leather, for Road Measuring Wheel, 2 safety locks, strong handle, colour: black, weight 2200 g

Art.No. **1290 0000**



**3 Pocket Spring Balances "ORIGINAL REBÜRE"**

with iron-brassed scale and bright galvanized hook and ring, housing and pointer painted black

**4 Spring Balances "ORIGINAL REBÜRE"**

standard execution, with iron-brassed, round scale and bright galvanized hook and ring, housing and pointer painted black



**5 Precision Dividers**

with square legs, made of forged steel with quick nut



**6 Scribers**

nickle plated, one side straight, other side bent, handle knurled with interchangeable spare points  
Art.No. **105** length 250 - Ø 8 mm

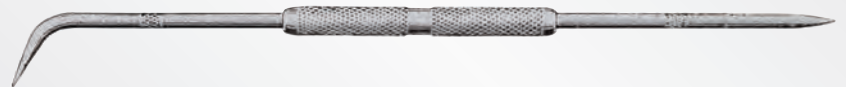

Range (kg)	<b>3</b>		Length (mm)	<b>5A</b>	<b>5B</b>	<b>5C</b>	<b>5D</b>
	Art.No.	Art.No.		Art.No.	Art.No.	Art.No.	Art.No.
<b>0-10.0</b>	102100	132010	<b>75</b>	1800-... 075	1801-... 075	1802-... 075	478-... -
<b>0-12.5</b>	102125	-	<b>100</b>	100	100	100	-
<b>0-20.0</b>	102200	-	<b>125</b>	125	125	125	-
<b>0-25.0</b>	102250	132025	<b>150</b>	150	150	150	101
<b>0-30.0</b>	102300	-	<b>175</b>	175	175	175	110
<b>0-50.0</b>	102500	132050	<b>200</b>	200	200	200	102
<b>0-100.0</b>	1021000	132100	<b>225</b>	225	225	225	-
<b>0-150.0</b>		132150	<b>250</b>	250	250	250	103
<b>0-200.0</b>		132200	<b>275</b>	275	275	275	-
<b>0-300.0</b>		132300	<b>300</b>	300	300	300	104
			<b>400</b>	400	400	400	108
			<b>500</b>	500	500	500	105
			<b>600</b>	-	-	-	109

**1 "JOKÜ" brand Precision Feeler Gauges hanging on a ring**  
blade width 13 mm

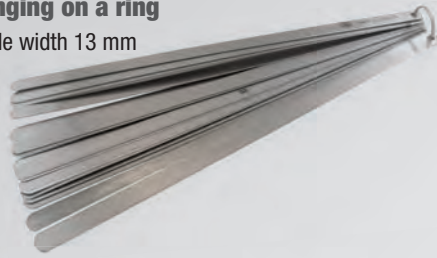

**2 "JOKÜ" brand Precision Feeler Gauges in nickel plated case**  
blade width 13 mm, blade length 100 mm



**3 "JOKÜ" brand Double Thread Calipers**

for outside and inside measurements, whitworth thread: 4-62, metric thread: 0.25 - 6.0

**3A 52 blades** Art.No. **405**

**3B 58 blades** Art.No. **406**

whitworth pipe thread: 8-28

**4 Protractors with locking screw**  
**4A polished**  
**4B stainless steel**



**5 "JOKÜ" brand Precision Micrometers**

acc. to DIN 863, with ratchet, outside - spindle hardened and ground Ø 6 mm, packed in wooden case, range 25 - 50 mm

Art.No. **504/25-50**



**6 Sliding Bevels**  
with iron stock and bright blade, light type - wing nut



**7 Pocket Slide Calipers**  
open slide, monoblock, fully hardened, 4-way with cross-points and depth gauge, stainless steel - chrome



**8 Joiner's Squares** with mitre, with two graduations

**8A light version**  
steel blade 30 mm

**8B heavy version**  
steel blade 35 mm



**9 Steel Square** carbon steel, zink plated

**9A without back**

**9B with back**



Length (mm)	Range (mm)	1A Art.No.		Blades	Range (mm)	2A Art.No.		2B Art.No.		Blade Size (mm)	Blade Width (mm)	9A Art.No.		9B Art.No.	
		13 Blades	20 Blades			2A	Range (inch)	2B	9A			9B			
200	0.05 - 1.00	202/4/200	202/6/200	8	0.05 - 0.50	100/3	2-20/1000	101/3	100 x 70	20	1200100	1300100			
300	0.05 - 1.00	202/4/300	202/6/300	13	0.05 - 1.00	100/7	2-25/1000	101/7	150 x 100	20	1200150	1300150			
400	0.05 - 1.00	202/4/400	202/6/400	20	0.05 - 1.00	100/10	2-35/1000	101/10	200 x 130	20	1200200	1300200			
500	0.05 - 1.00	202/4/500	202/6/500						250 x 160	25	1200250	1300250			
600	0.05 - 1.00	202/4/600	202/6/600						300 x 180	25	1200300	1300300			
									400 x 230	25	1200400*	1300400			
									500 x 280	25	1200500*	1300500			
									600 x 330	30	1200600	1300600			
									800 x 430	30	1200800	1300800			
									1000 x 500	30	1201000	1301000			

Ø - Length (mm)	4A Art.No.	4B Art.No.	Size (mm)	6 Art.No.	Range (mm)	7 Art.No.	Length (mm)	8A Art.No.	8B Art.No.
80 - 120	500/1	500R/1	150	955/150	140	252.201	150	1020150	1110150
120 - 150	500/2	500R/2	200	955/200	150	252.301	200	1020200	1110200
150 - 200	500/3	500R/3	250	955/250	200	252.304	250	1020250	1110250
200 - 300	500/4	500R/4	300	955/300	250	252.311	300	1020300	1110300
					300	252.312	350	1020350	1110350
							400	1020400	1110400

\* Blade width 25 or 30 mm

**1 Refills for "ROTAPLAST" Radiator Paint Rollers - 10 cm**

white with broad yellow line, glued, polyamide fabric, 10 pcs in a plastic box, then 840 pcs in a carton  
 Art.No. **K50.320**  
 Art.No. **K50.320H** including roller frame (Art.No. 87416 - 42 cm)



**2 Refills for "ROTAPLAST" Paint Rollers - 11 cm**

10 pcs in a plastic box with label, CFC free foam, glued

**2a** white colour, straight, fine quality

Art.No. **K50.420**

**2b** white colour, round face, fine quality

Art.No. **K50.427**

**2c** yellow colour, straight, for rustic wall structures with plasters or fillings

Art.No. **K50.440**

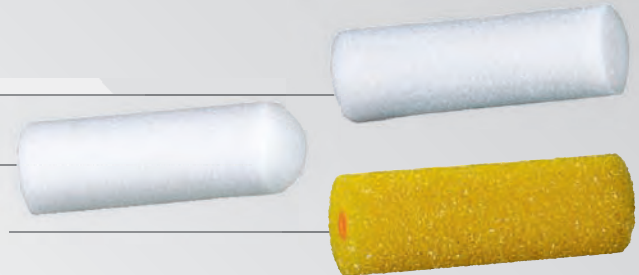

**3 Paint Roller Sets**

with roller frame and blue tray (15 x 27 cm)  
 including roller frame (Art.No. 87216 - 27 cm)  
 Art.No. **52420-53**



**4 Roller Frames**

handle: ROTERGO green, embossed with "Made in Germany"  
 20 pcs each in a carton



**5 Spike Rollers - 25 cm**

spike-length 12 mm  
 to drive out air inclusions in polyester and epoxy resin coatings by rolling

**5A Plastic spike** Art.No. **27069**    **5B Metal spike** Art.No. **27068**

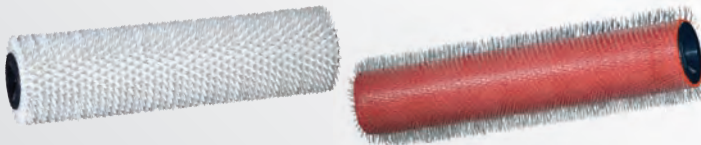

**6 Wallpaper Seam Rollers**

complete with strong handle, 10 pcs each in a carton  
 18 cm Art.No. **24090**  
 5 cm Art.No. **61090**



**7 Radiator Brushes**

with light bristles and wooden handle (unlacquered) - standard quality



**8 Ceiling Brushes - Size No. 1**

with plastic handle and clip, wooden body, size 170 x 70 mm

**8a** with PVC-bristles

Art.No. **87021**

**8b** with pure fibre bristles for Bitumen application

Art.No. **87011**



**9 Ceiling Brushes - Quality DUHALON - Size No. 2**

with black oval plastic body and black plastic handle with clip,  
 pure white DUHALON bristles, length 85 mm, size 180 x 85 mm

Art.No. **87086**



Length (cm)	Width (cm)	<b>4</b> Art.No.	Size (mm)	Size (inch)	<b>7</b> Art.No.
<b>27</b>	10-12	<b>87216</b>	<b>25</b>	<b>1.0"</b>	<b>435025-401</b>
<b>42</b>	10-12	<b>87416</b>	<b>35</b>	<b>1.5"</b>	<b>435035-401</b>
<b>66</b>	10-12	<b>87616</b>	<b>50</b>	<b>2.0"</b>	<b>435050-401</b>
<b>80</b>	10-12	<b>87816</b>	<b>60</b>	<b>2.5"</b>	<b>435065-401</b>
<b>30</b>	25-27	<b>80516</b>	<b>75</b>	<b>3.0"</b>	<b>435075-401</b>

**1 Classic Smoothing Trowels**

classic style, aluminium column, beechwood handle in red or blue

**2 Notched Smoothing Trowels**

classic style, aluminium column, beechwood handle in red or blue

**3 Modern Smoothing Trowels**

modern style, aluminium column, multicomponent handle in red/black, straight finish or with teeth

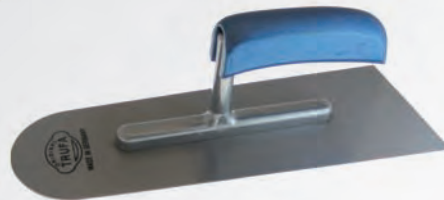
**4 Lebanese Style Smoothing Trowels**

with two steel columns and varnished wooden handle

**5 Belgian Style Smoothing Trowels**

half round nose, with two aluminium columns and varnished wooden handle

**6 Flooring Trowels**

pointed, with two aluminium columns and closed wooden handle in red or blue

**7 Plastic Finishing Trowels**

classic style  
140 x 280 mm  
180 x 320 mm  
200 x 360 mm

**BEST  
SELLER**

**8 Darby Plastic Finishing Trowels**

extra long

**9 Shaped Plastic Finishing Trowels**

Art.No.	Size (mm)	Notches (mm)	Art.No.	Size (mm)	Art.No.	Size (mm)
<b>1</b> 014.280	280 x 130 x 0.7		<b>5</b> 250-128	280 x 110 x 80 x 0.9	<b>8</b> 200080	111 x 800
<b>2</b> 014.284	280 x 130 x 0.7	4 x 4	<b>6</b> 260-145	450 x 90 x 70 x 1.2	200100	110 x 1000
014.286	280 x 130 x 0.7	6 x 6	260-150	500 x 90 x 70 x 1.2	200120	110 x 1200
014.288	280 x 130 x 0.7	8 x 8	260-160	600 x 90 x 70 x 1.2	<b>9</b> 200826	80 x 260
014.281	280 x 130 x 0.7	10 x 10	260-170	700 x 90 x 70 x 1.2		
<b>3</b> 014.280.2K	280 x 130 x 0.7		<b>7</b> 201219	120 x 109		
014.284.2K	280 x 130 x 0.7	4 x 4	201224	120 x 240		
014.286.2K	280 x 130 x 0.7	6 x 6	201423	140 x 230		
014.288.2K	280 x 130 x 0.7	8 x 8	<b>201428</b>	<b>140 x 280</b>		
014.281.2K	280 x 130 x 0.7	10 x 10	<b>201832</b>	<b>180 x 320</b>		
<b>4</b> 265-128	280 x 130 x 0.7		<b>202036</b>	<b>200 x 360</b>		

**1 Plastic Finishing Trowels**  
with rubber sponge - 20mm - rough finish

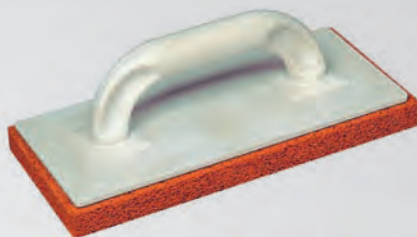

**2 Plastic Finishing Trowels**  
with "HYDRO" sponge support



**3 Plastic Smoothing Trowels**  
with blue coloured hollow PVC handle

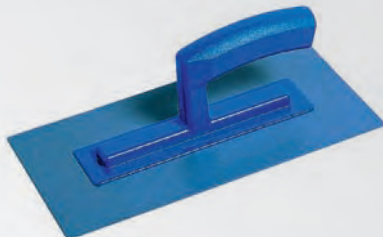

**4 Rubber Scrapers**  
for jointing seams - with beachwood handle



**5 Wall Scrapers - "JUCO" brand**  
made of polished spring steel with beechwood handle



**6 Notched Wall Scrapers**  
made of polished spring steel with beechwood handle



**7 Japan Scraper Sets**  
steel blade with plastic back  
cons. of 4 pcs/set: 50/80/100/120 mm

Art.No. [9/B/SA/OG](#)



**8 Knee Protectors - "Kniefix"**  
made of polyurethane - yellow colour

Art.No. [507002](#)



**9 Utility Knives**  
with die-cast grip - hammer grey enamel  
incl. 5 straight blades (Art. No. 57E)

Art.No. [57](#)



**10 Straight Blades**  
0,65 special hardened and polished steel  
packed in boxes of 12 pcs

Art.No. [57E](#)



**11 Hooked Blades**  
0,65 special hardened and polished steel  
- no deep-cut, packed in boxes of 12 pcs

Art.No. [57H](#)



	Art.No.	Size (mm)	Notches (mm)
<b>1</b>	<a href="#">421428</a>	140 x 280	
<b>2</b>	<a href="#">481428</a>	140 x 280	
<b>3</b>	<a href="#">641428</a>	140 x 280	
<b>4</b>	<a href="#">501502</a>	200	
	<a href="#">501504</a>	250	
	<a href="#">501503</a>	300	
<b>5</b>	<a href="#">810/200</a>	200	
	<a href="#">810/250</a>	250	
<b>6</b>	<a href="#">086028</a>	180	6 x 6
	<a href="#">086029</a>	250	6 x 6



### 1 Wallpaper Adhesives - No. 05 normal

professional adhesive,  
light to medium-weight wallpapers  
- contains methyl  
- ready for use in 30 mins  
packet 125g, 20 units Art.No. **05N**



### 2 Wallpaper Adhesives - No. 05 special

professional adhesive for all vinyl,  
embossed vinyl, woodchip and embossed  
wallpapers and heavy wallpapers  
- contains methyl cellulose  
- resin-reinforced  
- high initial and final bonding  
- ready for use in 30 mins  
packet 200g, 25 units Art.No. **05S**



### 3 Styrofoam Adhesives - No. 65

tube packing ready for use, white emulsion  
adhesive for adhering decorative mouldings,  
roses as well as Styropor® and polyurethane  
decoration and insulation panels.  
- solvent-free  
- ready for use  
- colour: white  
- for indoors  
- practical, re-closable tube  
packet 400g, 12 units Art.No. **065**



### 4 Adhesives for Ornamental Bordering - No. 71

adheres all commercial borders to wallpapers  
and wallcoverings  
- with integrated brush  
- practical, re-closable stand tube  
- solvent-free application  
- tube contents sufficient for approx. 10 m x 15 cm  
packet 250g, 12 units Art.No. **071**



### 5 Assembly Adhesives FIX - No. 92

powerful adhesive for secure, reliable gluing on wood,  
concrete, plaster, stone, metal and similar surfaces.  
For moulding patterns, skirting boards, wood panel-  
ling, panels, wood and PVC strips, decorative and  
insulating panels, ceramic tiles, etc. Temperature  
resistant from -20 to +70 °C after hardening  
-solvent free  
-for indoors and outdoors  
packet 400g, 15 units Art.No. **092**



### 6 decofill Ready-Mix Fillers - No. 144

ready for use white emulsion filler for smoothing  
uneven surfaces and for filling cracks and holes in  
walls and ceilings. Maximum layer, thickness: 5 mm  
- for quick repairs indoors  
- hardens crack-free  
- solvent-free  
packet 400g, 12 units Art.No. **144**



### 7 Fine Fillers - No. 134

for repairing and smoothing varnished and untreated  
wood, plaster, concrete, stone, plasterboards etc.  
Ideal surface for varnishing with resin- or acrylic  
varnishes. Ready for use in a practical,  
re-closable stand tube  
- solvent free  
- for indoors  
- max. 3 mm application thickness  
packet 400g, 12 units Art.No. **134**



### 8 Wood Putties - No. 138

Ready for use, natural brown emulsion-based wood  
putty for repairing wooden surfaces.  
- high filling capacity  
- hardens evenly and crack-free  
- can be sanded and overpainted  
- for indoors and with a weatherproof additional  
paint – also for outdoors  
- practical, re-closable tube  
packet 400g, 12 units Art.No. **138**

### 9 BOB Rustsealing Transparents - No. 9411

- stops and seals the rust – no prior rust removal
- works reliably and durably
- quick and simple processing

125 mL, 12 units Art.No. **9411-125**  
375 mL, 6 units Art.No. **9411-375**  
750 mL, 6 units Art.No. **9411-750**  
2500 mL, 4 units Art.No. **9411-2500**



### 10 BAO Brand Putties for Wood colourless, in tins



110 g Art.No. **700/1**  
250 g Art.No. **700/2**  
440 g Art.No. **700/3**  
1000 g Art.No. **700/4**

**1 decomix Universal Concentrated Colorants**

pigment concentrate for tinting lacquers, emulsion paints, synthetic resin plasters, fillers etc.

- extremely strong colour and economical
- 32 brilliant colour shades
- for tinting almost all materials
- excellent mixing performance
- very good light resistance
- space saving due to small volume
- all LW (light and weather resistant) oxide types are suitable for aromatic-free lacquer systems and silicate paints

available in bottles of:

- 20 mL, 10 units
- 200 mL, 10 units
- 500 mL, 20 units

<http://www.kistenmacher.de/decomix>



**2 decolor Tinting Paints - No. 113**

emulsion paint in 22 attractive colour shades for decorative painting as well as for toning emulsion paints and distemper.

- solvent-free
- low of emissions
- for indoors and outdoors
- non-fading
- weatherproof
- wet-scrub resistance
- suitable for use with airless sprays

available in bottles of:

- 250 mL, 10 units
- 750 mL, 10 units

<http://www.kistenmacher.de/decomix>



**3 Masking Tapes**

crepe masking tape for straight edges with display packing



**4 Double Sided Adhesive Tapes**

for carpets with display packing



**5 Anti Slip Tapes**

self-adhesive black colour with display packing



**6 Felt Gliders for Parquet**

self-adhesive, natural colour, extra gliding ability, extra smooth, low noise, blister packing, 180 units



**7 Felt Gliders and Felt Pad**

self-adhesive, with display packing  
 white colour Art.No. ...-01  
 brown colour Art.No. ...-07



	Width (mm)	Length (m)	Units	Art.No.		Size (mm)	qty./ pack	Art.No.		Size (mm)	qty./ pack	Units	Art.No.		Size (mm)	qty./ pack	Units	Art.No.
<b>3</b>	<b>19</b>	50	48	47719	<b>6</b>	<b>22</b>	16	7062216	<b>7</b>	<b>17</b>	20	270	75		<b>22 x 22</b>	16	270	78
	<b>25</b>	50	36	47725		<b>25</b>	9	7062509		<b>17</b>	60	60	7560		<b>22 x 22</b>	48	60	7848
	<b>30</b>	50	32	47730		<b>28</b>	9	7062809		<b>22</b>	16	270	76		<b>25 x 25</b>	9	270	725259
	<b>38</b>	50	24	47738		<b>35</b>	4	7063504		<b>22</b>	48	60	7648		<b>25 x 25</b>	27	60	7252527
	<b>50</b>	50	24	47750		<b>20 x 20</b>	16	7062016		<b>25</b>	9	270	7259		<b>32 x 32</b>	6	270	732326
<b>4</b>	<b>5</b>	5	24	52550	<b>25 x 25</b>	9	7062525	<b>25</b>	27	60	72527	<b>32 x 32</b>	18	60	7323218			
	<b>10</b>	24	521050	<b>20 x 40</b>	8	7062008	<b>28</b>	8	270	77	<b>22 x 36</b>	8	270	79				
	<b>25</b>	30	522550	<b>95 x 80</b>	1	7068001	<b>28</b>	24	60	7724	<b>16 x 44</b>	8	270	80				
<b>5</b>	<b>19</b>	3	6	126-08	<b>200 x 100</b>	1	7061020	<b>35</b>	4	270	74							
	<b>38</b>	3	3	12638-08				<b>35</b>	12	60	7412							





**1 Felt Gliders**  
with pin  
**1A display card holder**  
**1B bilster packing**



**4 Polyethylene Strings**  
on spools of 50 m,  
12 spool per carton  
**4A Ø 1.0 mm**  
**4B Ø 2.0 mm**



**7 White Polyurethane Foam Tapes**  
fine open-cell, with brown PVC backing, not UV-resistant, highly compressible and very adaptable  
**7A thickness 6 mm**  
**7B thickness 8 mm**  
**7C thickness 9 mm**  
**7D thickness 10 mm**



**2 Draught Excluders**  
door mounted draught excluder,  
self adhesive, for gaps up to 20 mm,  
length 1 m



**3 Bridging Profiles**  
length 90 cm, 10 units



**2A aluminium pure-bristle brush, 10 units**  
**silver** Art.No. **41**  
**brass** Art.No. **42**  
**gold** Art.No. **43**  
**2B plastic with PVC-lip, 20 units**  
**white** Art.No. **45-01**  
**brown** Art.No. **45-07**

**3A aluminium**  
**silver, width 30 cm** Art.No. **10201**  
**gold, width 30 cm** Art.No. **10101**  
**brass, width 30 cm** Art.No. **10001**  
**3B iron brass**  
**gold, width 30 cm** Art.No. **9001**  
**gold, width 40 cm** Art.No. **9041**



**5 Polypropylene Cords - Multifil**  
12 spools per carton  
**5A Ø 1.0 mm** on spools of 50 m  
**5B Ø 2.0 mm** on spools of 50 m  
**5C Ø 1.0 mm** on spools of 100 m  
**5D Ø 2.0 mm** on spools of 100 m

**6 Tile Spacers**  
in poly bag  
**6A 250 pcs / bag**  
**6B 200 pcs / bag**  
**6C 100 pcs / bag**



**8 Cork Inseal Pads**  
on roll with paper layer self-adhesive, cork stacking discs are ideal spacers for glass, plastics, wood and many other sensitive surfaces, simple to use as transport and storage protection, easy to remove again  
**8A thickness 6 mm** size 15 x 15,  
60.000 pcs per carton Art.No. **L5507-2**  
**8B thickness 8 mm** size 18 x 18,  
30.000 pcs per carton Art.No. **L5507-3**

Colour	Size (mm)	qty/ pack	Units	Art.No. 1A	qty/ pack	Units	Art.No. 1B
white	20	8	100	71	16	60	7116-01
white	24	8	100	72	16	48	7216-01
white	28	4	80	73	16	36	7316-01
brown	20	8	100	71-07	16	60	7116-07
brown	24	8	100	72-07	16	48	7216-07
brown	28	4	80	73-07	16	36	7316-07

Colour	Art.No. 4A	Art.No. 4B	Art.No. 5A	Art.No. 5B	Art.No. 5C	Art.No. 5D
red	P23	P232	N85R	N852R	-	-
white	P23W	P232W	N85W	N852W	N85100W	N852100W
green	P23G	P232G	N85G	N852G	-	-
yellow	P23Y	P232Y	-	-	-	-

Size (mm)	Art.No. 6A	Art.No. 6B	Art.No. 6C
2 x 28	20250L	20200L	20100L
2.5 x 28	25250L	25200L	25100L
3 x 28	30250L	30200L	30100L
4 x 22	40250	40200	40100
5 x 22	50250	50200	50100
6 x 24	60250	60200	60100
8 x 30	-	80200	80100
10 x 30	-	-	10100

Size (mm)	Length (mtr)	pcs/ carton	Art.No. 7A	Art.No. 7B	Art.No. 7C	Art.No. 7D
5.0	9	33	-	-	14003-03/9/9	-
10	12	25	14003-03/12	-	-	-
7.5	15	20	-	14003-03/15/8	-	-
10	15	20	14003-03/15	-	-	-
7.5	19	16	-	14003-03/19/8	-	-
10	19	16	14003-03/19	-	-	14003-03/19/10
7.5	25	12	-	14003-03/25/8	-	-
10	25	12	14003-03/25	-	-	-
10	30	10	14003-03/30	-	-	-

**1 Mirror Caps**  
with 1/8" threaded pin  
**1A pointed**  
**1B rounded**



**2 Iron Screws**  
with inner thread 1/8"  
specially made for  
mirror caps, steel  
galvanized, Ø 4.5 mm



Ø (mm)	Art.No. 1A	Art.No. 1B	Length (mm)	Art.No. 2	Head Ø	Head height	Art.No. 4A	Packing Unit
10	..	349/10	15	357/15	6.0	1.60	1 1/4	1000
12	348/12	..	20	357/20	6.5	1.80	20 1/3	1000
13	..	349/13	25	357/25	7.5	2.20	50 1/3	1000
15	..	349/15	30	357/30	8.0	2.30	60 1/3	1000
16	348/16	..	35	357/35	9.0	2.40	90 1/3	1000
18	..	349/18	40	357/40	9.5	2.50	100 1/3	1000
19	348/19	..	50	357/50	10.0	2.80	110 1/3	1000
20	..	349/20	60	357/60	11.0	2.80	130 1/3	1000
24	348/24	349/24	70	357/70	12.5	3.00	160 1/3	1000
			80	357/80	14.0	4.00	1507	1000
					16.0	4.20	1505	500
					18.0	4.50	1504	500
					20.0	5.00	1503	500
					22.0	5.50	1501	500
					24.0	6.00	1500	250
					26.0	8.00	1499	250
					28.0	7.00	1498	250
					30.0	8.00	1497	250

**3 Mirror Clamps Sets**  
4-piece, with 2 upper parts  
and 2 lower parts and 4 screws

Art.No. **6503 GE 0000 2**

steel nickel-plated, in polybag packing

Art.No. **6503 SS 0000 2**

stainless steel, with additional  
4 wall plugs, in carton packing



**4/5 Furniture Nails**

**4A flat head chair nails**

**4B domed head chair nails**

**5 decorative nails**

Please add colour code to art.no.:

Colour Group I

No. **050** - brass plated, polished

No. **031** - nickle plated, polished

Colour Group II

No. **013** - browned light

No. **055** - old gold spotted light

No. **054** - old gold spotted normal

Colour Group III

No. **058** - brass relieved, polished

No. **011** - copper relieved, polished

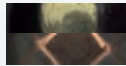
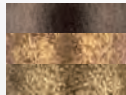

**6 VITOMOUNT Mirror Tapes**  
colour: white, two side-adhesive, in rolls of 66 m,  
13 pcs per carton

**6A thickness 6 mm** covered with green silicon-foil  
25 x 1 mm Art.No. **125-SS-70 PE**

**6B thickness 8 mm** covered with brown silicon-foil  
19 x 1 mm Art.No. **125-SS-70 PBR**



**7 PRYM brand**

of brass, matt  
\*\* polished version

**6A Eyelets**

**6B Washers**



Head Ø	Head height	Art.No. 7A	Art.No. 7B	Packing unit
8.0	0B	541112**	541113**	1000
9.5	2B	541270**	541275**	200
10.5	3B	541150	541149	200
11.5	4B	541151	541153	200
12.5	5B	541177	541155	200
13.5	6B	541176	541175	200
14.0	7B	541182	541159	200
15.0	8B	541174	541161	100
17.5	9B	541179	541163	100
19.5	10B	541171	541165	100
23.5	12B	541168**	541169**	100
28.5	14B	541170**	541173**	100

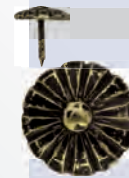

**1 Fixing Sets**  
in poly bag packing



**1A for Water Boilers**  
Size 10 x 95 mm Art.No. 5771 00 1095 1



**1B for Washbasin**  
Size 10 x 140 mm  
Art.No. 5772 10 0140 1



**1c for WC and Bidet**  
Size 6 x 70 mm Art.No. 5773 04 6070 1  
Size 6 x 90 mm Art.No. 5773 04 6090 1



**2 Steel Collars for Light Pipes**  
band size 16 x 1.2 mm,  
thread M6, bulk packing 100 pcs

**3 Steel Collars**  
screw with threaded steel,  
with wall plug, blister packing  
**3A** 4 + 4 + 4 pcs / pack  
**3B** 3 + 3 + 3 pcs / pack



**4 NORMA brand Hose Clips TORRO**  
in carton box packing  
**4A** W1 width 9mm  
**4B** W1 width 12mm



**5 Brass Tube Sockets**



**5A** polished  
**5B** nickel plated



**5c** angle type - polished  
**5d** angle type - nickel plated



**5E** straight type - polished  
**5F** straight type - nickel plated

pipes for (mm)	Art.No.	Type	Range mm	Art.No. 4A	Art.No. 4B
14	1402	CT14	8-12	W1/8-12	-
16	1403	CT16	10-16	W1/10-16	-
18	1404	CT18	12-18	W1/12-18	-
20	1405	CT20	12-22	W1/12-22	-
22	1406	CT22	16-27	W1/16-27	W1/16-27/12
24	1407	CT24	20-32	W1/20-32	W1/20-32/12
26	1408	CT26	25-40	W1/25-40	W1/25-40/12
28	1409	CT28	30-45	W1/30-45	W1/30-45/12
			35-50	W1/35-50	W1/35-50/12
	<b>3A</b>		40-60	W1/40-60	W1/40-60/12
14	3191	CTV 14.S	50-70	W1/50-70	W1/50-70/12
16	3192	CTV 16.S	60-80	W1/60-80	W1/60-80/12
18	3193	CTV 18.S	70-90	W1/70-90	W1/70-90/12
20	3194	CTV 20.S	80-100	W1/80-100	W1/80-100/12
22	3195	CTV 22.S	90-110	W1/90-120	W1/90-110/12
24	3196	CTV 24.S	100-120	-	W1/100-120/12
			110-130	-	W1/110-130/12
			120-140	-	W1/120-140/12
	<b>3B</b>		130-150	-	W1/130-150/12
26	3197	CTV 26.S	140-160	-	W1/140-160/12
28	3198	CTV 28.S	150-170	-	W1/150-170/12
			160-180	-	W1/160-180/12
			180-200	-	W1/180-200/12
			200-220	-	W1/200-220/12

Ø mm - inch	Art.No. 5A	Art.No. 5B	Art.No. 5C
10 - 3/8"	0021-9210-014	0021-9210-015	0021-9310-014
13 - 1/2"	0021-9213-014	0021-9213-015	0021-9313-014
16 - 5/8"	0021-9216-014	0021-9216-015	0021-9316-014
19 - 3/4"	0021-9219-014	0021-9219-015	0021-9319-014
25 - 1"	0021-9225-014	0021-9225-015	0021-9325-014

	Art.No. 5D	Art.No. 5E	Art.No. 5F
10 - 3/8"	0021-9310-015	0021-9410-014	0021-9410-015
13 - 1/2"	0021-9313-015	0021-9413-014	0021-9413-015
16 - 5/8"	0021-9316-015	0021-9416-014	0021-9416-015
19 - 3/4"	0021-9319-015	0021-9419-014	0021-9419-015
25 - 1"	0021-9325-015	0021-9425-014	0021-9425-015

**1 Sets of Anchors and Pozidriv Screws**

KISTENMACHER brand



**2 Wall Plugs**

KISTENMACHER brand



**3 Wall Plugs**

Expandet brand  
in carton packing



**4 Nylon Wing Toggles HS**

Type HS 10+17



**5 Wooden Dowels**

beach wood in bags of 10 kgs



**6 Expandet brand Chemical Anchors**



**7 Steel Pins for Picture Hangings**

with brass covered head,  
material: hardened steel, blued



**8 Steel Hooks**

material: hardened,  
blue tempered steel, square wire

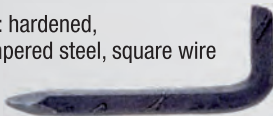

**9 Steel Nails**

blue tempered steel, material: hardened,  
tallow drop head



**10 Quality Steel Nails**

with grooves, with countersunk head



Size	Length (mm)	Art.No.	Wire	Length (mm)	Art.No.	Packing Unit	
<b>1</b>							
4.0	20	280420/EGK					
5.0	25	280525/EGK					
6.0	30	280630/EGK					
8.0	40	280840/EGK					
10.0	50	281050/EGK	2.0	20	345/20	100	
12.0	60	281260/EGK	2.0	25	345/25	100	
<b>2</b>							
4.0	20	260420	2.2	30	345/30	100	
5.0	25	260525	2.5	40	345/40	100	
6.0	30	260630	2.5	50	345/50	100	
8.0	40	260840	2.5	60	345/60	100	
10.0	50	261050	3.0	70	345/70	100	
12.0	60	261260	4.0	50	345/504	100	
14.0	70	261470	4.0	60	345/604	100	
16.0	80	261680	4.0	70	345/704	100	
5.0	100	345/100	5.0	100	345/100	100	
<b>3</b>							
4.0	25	1204251	yellow	<b>9</b>			
5.0	25	1205251	white	2.0	12	B2320-12	1000
5.0	35	1205351	white	2.0	16	B2320-16	1000
6.0	25	1206251	red	2.0	20	B2320-20	1000
6.0	35	1206351	red	2.0	25	B2320-25	1000
7.0	25	1207251	green	2.0	30	B2320-30	1000
7.0	30	1207301	green	2.0	35	B2320-35	1000
7.0	35	1207351	green	2.0	40	B2320-40	1000
7.0	50	1207501	green	2.5	20	B2325-20	1000
8.0	25	1208251	blue	2.5	25	B2325-25	1000
8.0	35	1208351	blue	2.5	30	B2325-30	1000
8.0	50	1208501	blue	2.5	40	B2325-40	1000
10.0	35	1210351	orange	2.5	50	B2325-50	1000
10.0	50	1210501	orange	2.5	60	B2325-60	1000
10.0	60	1210601	orange	3.0	30	B2330-30	1000
12.0	50	1212501	grey	3.0	40	B2330-40	1000
12.0	60	1212601	grey	3.0	50	B2330-50	1000
12.0	75	1212751	grey	3.0	60	B2330-60	1000
				3.0	70	B2330-70	1000
				3.0	80	B2330-80	1000
				3.5	40	B2335-40	1000
				3.5	50	B2335-50	1000
10	40	1050	4-12	3.5	60	B2335-60	1000
10	47	1051	15-19	3.5	70	B2335-70	1000
				3.5	80	B2335-80	1000
6	30	67121		<b>10</b>			
8	30	67221		2.7	20	6127-20	250
8	35	67231		2.7	30	6127-30	250
8	40	67421		2.7	40	6127-40	250
10	50	67631		2.7	50	6127-50	250
				2.7	60	6127-60	250
8	80	900008		3.5	30	6135-30	250
10	80	900010		3.5	40	6135-40	250
12	95	900012		3.5	50	6135-50	250
16	95	900016		3.5	60	6135-60	250
20	170	900020		3.5	70	6135-70	250
24	210	900024		3.5	80	6135-80	250
Head dia.			Packing Unit				
				4.5	40	6145-40	250
6	20	344/20	100	4.5	50	6145-50	250
6	25	344/25	100	4.5	60	6145-60	250
6	30	344/30	100	4.5	70	6145-70	250
6	40	344/40	100	4.5	80	6145-80	250
6	50	344/50	100	4.5	90	6145-90	125
6	60	344/60	100	4.5	100	6145-100	125

**1 THREE STARS Marking Crayons**  
size: 12 x 120 mm,  
1 dozen in a carton-box



**2 LYRA brand Marking Crayons**  
size: 11 x 110 mm  
1 dozen in a carton-box



**3 Carpenter Pencils**  
Type 333Profi,  
oval shape - red polished  
100pcs in display-box



Colour	Art.No.
	<b>1</b>
white	12012-1
yellow	12012-2
red	12012-3
blue	12012-4
green	12012-6
black	12012-7

	<b>2</b>
white	795001
yellow	795007
red	795017
blue	795051
green	795067
black	795099

length cm	<b>3</b>
18	4331103
24	4332103
30	4333103

Ø mm	<b>5a</b>
8	753080
10	753100
12	753120
14	753140
16	753160
	<b>5b</b>
10	751100
12	751120

**4 Wire for Lead Seals**  
galvanized, size: 0.50/0.30 mm  
approx. 96 m 250 g/spool Art.No. 1115030-05  
approx. 193 m 500 g/spool Art.No. 1115030-06  
approx. 385 m 1000 g/spool Art.No. 1115030-07



**5 Lead Seals**  
Pb940R EN 12659  
**5A** in bags of 1Kg  
**5B** in bags of 1000pcs



**6 Lead Sealing Pliers**  
with straight handles  
**6A** polished  
**6B** nickel-plated,  
with blue coated handles

length mm	punch Ø mm	<b>6a</b>
130	8.0	25/0000
150	9.0	25/000
170	10.0	25/00
190	11.0	25/0A
220	12.0	25/0B
		<b>6b</b>
130	8.0	25/0000 bl
150	9.0	25/000 bl
170	10.0	25/00 bl
190	11.0	25/0A bl
220	12.0	25/0B bl

**7 Sealing Clips**  
**7A coppered finishes**  
length 25 mm,  
thickness 0.35/0.50 mm,  
1000 pcs/box



**7B iron brights**  
length 25 mm,  
thickness 0.50 mm,  
1000 pcs/box



**7C bright finishes**  
size: 32 x 57 x 0.90 mm,  
500 pcs/box

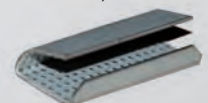

**8 Steel Straps**  
bright, cold-rolled,  
thickness 0.50 mm,  
in rings of 15,- kos,  
2 rings each bundled



Size (inch)	Size (mm)	Art.No. <b>7A</b>	Art.No. <b>7B</b>	Art.No. <b>7C</b>	Art.No. <b>8</b>
1/2"	13	76175 2512	76175 2512B		76180 0012
5/8"	16	76175 2558	76175 2558B		76180 0058
3/4"	19	76175 2534	76175 2534B		76180 0034
1.1/4"	32			76175 32114	

**1 Revolving Punch Pliers**

with additional hole diameter indicator, automatic lock function, exchangeable tubes Ø2.0-4.5 mm, bright nickel-plated, single packed in cardboard boxes, size: 225 mm / 9"

**1A with plain handles**  
Art.No. **0910-3501(B)**

**1B with red plastic coated handles**  
Art.No. **0910-3509(B)**



**2 Revolving Punch and Eyelet Pliers**

automatic lock function, bright nickel-plated, with ergonomical shaped red plastic handles, size: 225 mm / 9", single packed in cardboard boxes  
Art.No. **0920-3601(B)**



**3 Lever Action Revolving Punch Pliers**

with additional hole diameter indicator, exchangeable tubes Ø 2.0-4.5 mm, bright nickel-plated, with ergonomical shaped red plastic handles, size: 250 mm / 10", single packed in cardboard boxes  
Art.No. **0930-3718(B)**



**4 GEWA brand Spanning and Sealing Machines**

body made of high-grade steel

- 4A model SIMPLEX I** - incl. 1 knife only
- 4B model SIMPLEX II** - with 3 knives (knife changing device)
- 4C model FAVORIT 100** - adjustable for 3 band width
  - no-seal joint for steel strap
  - can be used with all kind of high-quality steel bands
  - thickness 0.5 mm, band guiding with ring marking
- 4D model FAVORIT 2000** - no-seal joint for steel strap
  - can be used with all kind of high-quality steel bands
  - thickness 0.38/0.60 mm

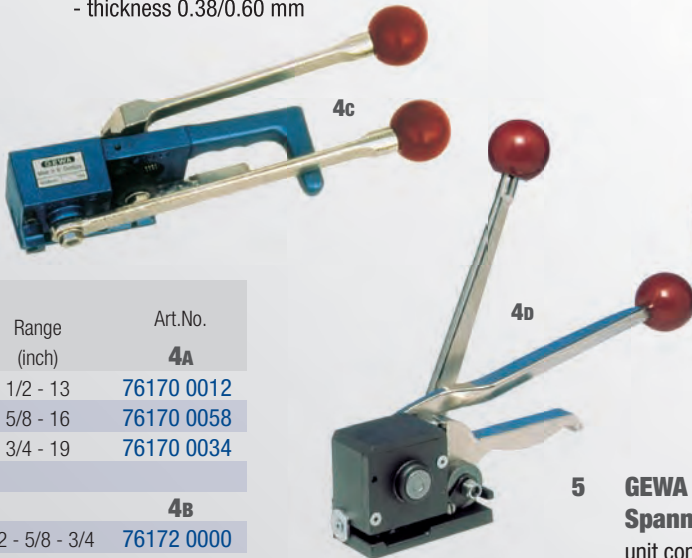

Range (inch)	Art.No.
	<b>4A</b>
1/2 - 13	76170 0012
5/8 - 16	76170 0058
3/4 - 19	76170 0034
	<b>4B</b>
1/2 - 5/8 - 3/4	76172 0000
	<b>4C</b>
1/2 - 5/8 - 3/4	F100
	<b>4D</b>
1/2 - 13	F2000-13
5/8 - 16	F2000-16
3/4 - 19	F2000-19
	<b>5</b>
1 - 25	Certex25
1.1/4 - 32	Supra32

**5 GEWA brand Heavy Duty Spanning and Sealing Machines**

unit consists of two tools - a stretching mechanism as well as a pair of closing tongs for steel straps - easy to handle - extra long closing seal guarantees highest security, as up to 8 notching points are possible



**1 Lead Sheets**

made of Pb99,94 Cu, acc. to DIN EN 12588, packed in rolls of 50 kg, each 20 rolls on a pallet, wrapped with shrinkfoil, width 1000 mm

Size (mm)	Length	1
1.5	2900	16505
2.0	2200	10431
2.5	1750	16911
3.0	1500	10537

**2 Threaded Rods**

grade 4,8, zinc plated, DIN 975 raw material: mild steel grade Q195/Q235, packed in bundles of abt. 20 kg

- 2A 1 m length
- 2B 2 m length
- 2c 3 m length
- 2d 4 m length

**4 Slotted »U« Rails**

size: 6 x 16 x 0.7 x 3500 mm, distance of holes: 98 mm, 100 pcs per carton

Art.No. **990** steel nickel plated Art.No. **985** steel brass plated

**5 Brackets, 16 mm for slotted »U« Rails**

300 pieces per carton

Art.No. **1020** steel nickel plated Art.No. **1019** steel brass plated

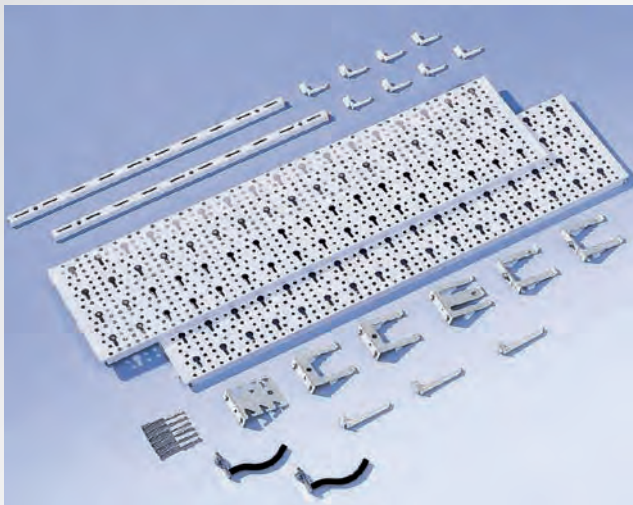
**6 Tool Suspension Sets**

organised storage in the minimum of space, complete kit comprising: 2 perforated steel panels 800 x 200 mm, 2 wall uprights, 500 mm, screws and wall plugs included, numerous practical accessories, total size 40 x 80 cm. Can be extended

**6A Set 19 RAL 9003 white**  
19 tool holders of various types - Art.No. **11300-00000**

**6B Set 19 RAL 9006 silver**  
19 tool holders of various types Art.No. **11300-00009**

**6c Set 9 RAL 9003 white**  
9 tool holders of various types Art.No. **11300-00004**

**6d BasicSet RAL 9003 white**  
without tool holders Art.No. **11300-00005**

**3 Piano Hinges**

size 32 x 0.6 mm, in lengths of 3500 mm, 100 lengths per case

Art.No. **3206 K**  
Art.No. **3206 K/3480**  
Art.No. **3206 M**  
Art.No. **3206 N**  
Art.No. **3206 S**

iron brass-colour painted (khaki)  
colour as a.m. / lengths of 3480 mm  
iron brass plated  
nickel plated  
stainless steel

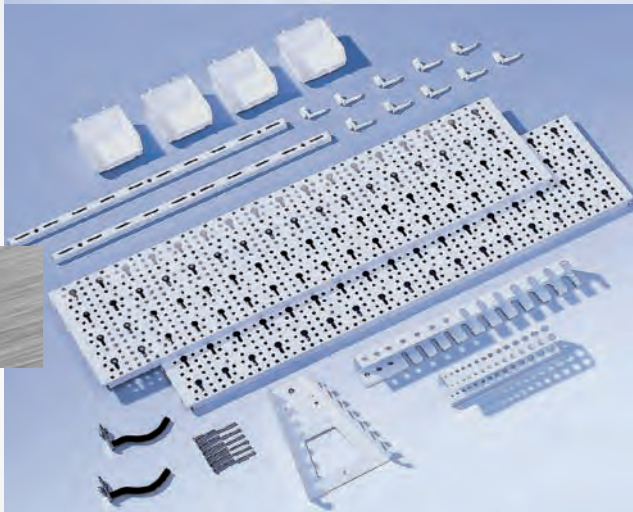

Size mm	Art.No.	Art.No.	Art.No.	Art.No.
	2A	2B	2c	2d
M 6	EGK M06x1MTRS	EGK M06x2MTRS	EGK M06x3MTRS	EGK M06x4MTRS
M 8	EGK M08x1MTRS	EGK M08x2MTRS	EGK M08x3MTRS	EGK M08x4MTRS
M 10	EGK M10x1MTRS	EGK M10x2MTRS	EGK M10x3MTRS	EGK M10x4MTRS
M 12	EGK M12x1MTRS	EGK M12x2MTRS	EGK M12x3MTRS	EGK M12x4MTRS
M 14	EGK M14x1MTRS	EGK M14x2MTRS	EGK M14x3MTRS	EGK M14x4MTRS
M 16	EGK M16x1MTRS	EGK M16x2MTRS	EGK M16x3MTRS	EGK M16x4MTRS
M 18	EGK M18x1MTRS	EGK M18x2MTRS	EGK M18x3MTRS	EGK M18x4MTRS
M 20	EGK M20x1MTRS	EGK M20x2MTRS	EGK M20x3MTRS	EGK M20x4MTRS
M 22	EGK M22x1MTRS	EGK M22x2MTRS	EGK M22x3MTRS	EGK M22x4MTRS
M 24	EGK M24x1MTRS	EGK M24x2MTRS	EGK M24x3MTRS	EGK M24x4MTRS



**1 Wall Uprights - Single-Slotted -**  
suitable as end elements for wallmounted shelf units in combination with double slotted uprights - pair packing

- 1A RAL 9003 white**
- 1B RAL 9006 silver**
- 1C RAL 8014 brown**

**2 Wall Uprights - Double-Slotted -**  
permit shelves, baskets, etc. to be mounted immediately alongside each other - pair packing

- 2A RAL 9003 white**
- 2B RAL 9006 silver**
- 2C RAL 8014 brown**

**3 Angle Brackets**  
suspension hooks, specific left-hand and right-hand, designs permit use as attractive brackets for the ends of shelves - pair packing

- 3A RAL 9003 white**
- 3B RAL 9006 silver**
- 3C RAL 8014 brown**



**4 Safety Brackets with 2 lugs**  
can be used with all types of wall uprights

- 4A RAL 9003 white**
- 4B RAL 9006 silver**
- 4C RAL 8014 brown**

**5 Clip-On Holders**  
support for wooden and glass shelves, 12 pcs/box

- 5A single sided** Art.No. **11604-00001**
- 5B two sided** Art.No. **11612-00001**



**6 Suction Pads**  
can be installed in clip-on and insert holders to support glass or wooden shelves, 20 pcs/box  
Art.No. **11605-00001**



**7 U-Brackets**  
can be used with double slotted wall upright  
**7A RAL 9003 white**  
**7B RAL 9006 silver**  
**7C RAL 8014 brown**



**8 Steel Shelves**  
can be used with brackets - Ref. No. 10105  
**8A RAL 9003 white**  
**8B RAL 9006 silver**

**9 Perforated Steel Panels**  
suitable for use with all wall-mounted tracks  
**9A RAL 9003 white**  
**9B RAL 9006 silver**

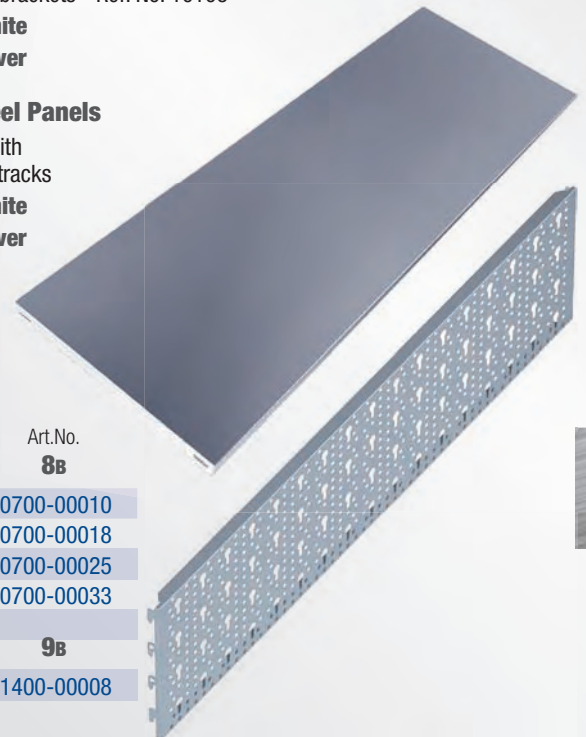

Length (cm)	Art.No. 1A	Art.No. 1B	Art.No. 1C
50	10000-00000	10000-000005	10000-000003
80	10000-00010	10000-000014	10000-000012
100	10000-00017	10000-000023	10000-000020
150	10000-00028	10000-000034	10000-000031
200	10000-00039	10000-000044	10000-000041
250	10000-00049	10000-000054	10000-000051

	2A	2B	2C
50	10001-00001	10001-000005	10001-000003
100	10001-00010	10001-000014	10001-000012
150	10001-00019	10001-000023	10001-000021
200	10001-00028	10001-000032	10001-000030
250	10001-00037	10001-000041	10001-000039

	3A	3B	3C
18	10300-00019	10300-00023	10300-00021
23	10300-00026	10300-00030	10300-00028
28	10300-00033	10300-00037	10300-00035
33	10300-00040	10300-00044	10300-00042
38	10300-00047	10300-00051	10300-00049
48	10300-00000	10300-00004	10300-00002

	4A	4B	4C
10	10105-00001	10105-00003	10105-00004
15	10105-00101	10105-00103	10105-00104
20	10105-00201	10105-00203	10105-00204
25	10105-00301	10105-00303	10105-00304
30	10105-00401	10105-00403	10105-00404
35	10105-00501	10105-00503	10105-00504
40	10105-00601	10105-00603	10105-00604
50	10105-00801	10105-00803	10105-00804

	7A	7B	7C
12	1200-00000	1200-00004	1200-00002
17	1201-00002	1201-00006	1201-00004
22	1201-00008	1201-00012	1201-00010
27	1201-00015	1201-00019	1201-00017
37	1201-00021	1201-00025	1201-00023
47	1201-00027	1201-00031	1201-00029
52	1201-00032	1201-00036	1201-00034
57	1201-00037	1201-00041	1201-00039

Size cm	Art.No. 8A	Art.No. 8B
20 x 80	10700-00004	10700-00010
25 x 80	10700-00012	10700-00018
30 x 80	10700-00020	10700-00025
35 x 80	10700-00027	10700-00033
	9A	9B
20 x 80	11400-00004	11400-00008

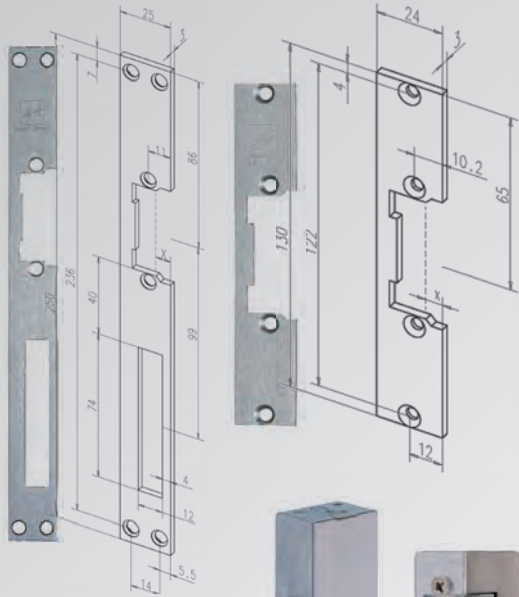

**1 eff-eff brand Flat Striking Plates**

DIN left and right usable, thickness 3 mm

- 1A** Art.No. **02135-01** size 250 x 25 mm with dead bolt cutout  
**1B** Art.No. **09635-01** size 130 x 24 mm with latch bolt aperture

**2 eff-eff brand Electric Door Openers**

classic modell - surface mounted

- 2A** Art.No. **10K/6-12** 6-12V  
**2B** Art.No. **10K/24** 24V

**3 eff-eff brand Electric Door Openers**suitable for all common striking plates housing made of die-cast zinc  
- suitable for DIN right and left due to 180° fitting, 6-12V

- 3A** Art.No. **14/D11** size: 90 x 20.0 mm - depth 28.2 mm  
**3B** Art.No. **17/D11** size: 75 x 20.5 mm - depth 28.0 mm

**4 eff-eff brand Mortise Latches**

small, easily mounted version - can be used as an additional locking mechanism in combination with fail unlocked electric strike

- Art.No. **802/00** size: 55 x 20.0 mm - depth 30.0 mm

**6 eff-eff brand Push-Buttons**surface-mounted push-button with key symbol - white colour  
size: 60 x 61.0 mm - depth 22 mm

- Art.No. **1010/00**

**5 eff-eff brand Rim Latches**matching part for surface-mounted door strikes  
- suitable for special structures  
- is used as additional locking device with fail-unlocked door strike

- Art.No. **804/00** size: 20 x 34.0 mm - depth 44.0 mm

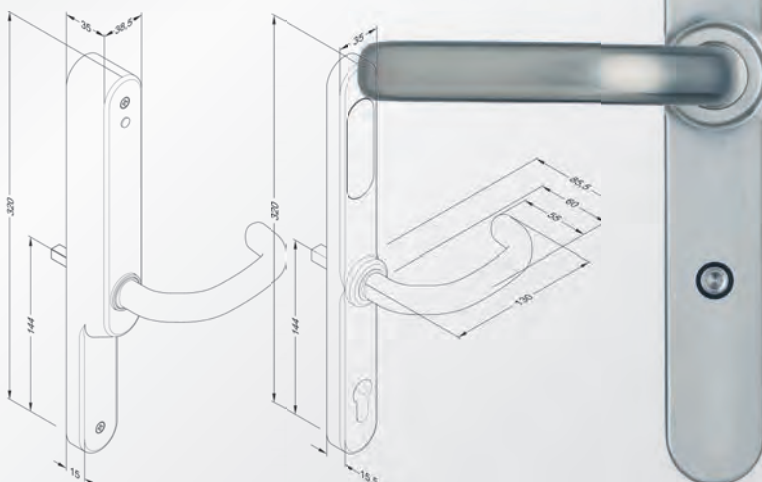
**7 eff-eff brand ANYKEY® Security Door Fittings**the access code version of ANYKEY® is the ideal solution for applications requiring increased security  
- designed for three to eight digit codes thus enabling a maximum of 100 million potential codes - stand alone device, suitable for door leaf thickness from 38 - 43 mm  
scope of delivery: 1 interior door fitting, 1 exterior door fitting, 1 mounting accessory kit, 4 batteries (type AA)

- Art.No. **49610804011-B86**



The World in Motion.

**Castor – Swivel Type**

- A** double ball bearing swivel head, wheel axle with nut
- B** precision ball bearing, with threadguards
- C** sealed swivel double ball bearing, reinforced and heat-treated ball covers, riveted king pin, wheel axle with nut
- D** sealed single swivel double ball bearing, threaded king pin and locking nut secured, grease nipple, wheel axle with nut

**Castor – Fixed Type**

- A** fork made of pressed steel, zinc-chromatised, wheel axle with nut
- B** fork and wheels made from high grade synthetic materials
- C** fork made of heavy pressed steel, reinforced, yellow zinc plated, wheel axle with nut
- D** fork and plate steel welded, zinc-chromatised, wheel axle with nut

**Castor – Brake Type**

- A** with total lock, tail end of castor, double ball bearing swivel head, wheel axle with nut
- B** with total lock, tail end of castor, precision ball bearing, with threadguards
- C** with wheel brake, double ball bearing swivel head, wheel axle with nut
- D** with total lock, tail end of castor, sealed swivel double ball bearing, reinforced and heat-treated ball covers, riveted king pin, wheel axle with nut
- E** with total lock, head end of castor, sealed single swivel double ball bearing, threaded king pin and locking nut secured, grease nipple, wheel axle with nut

**1 Castor Wheels**

housing made of pressed steel, zinc-chromatised, wheel centre made of pressed steel  
Tread: solid rubber, with threadguards, grey non-marking, plain bearing  
Swivel Type A    Fixed Type A    Brake Type A

**2 Castor Wheels**

housing made of pressed steel, zinc-chromatised, wheel centre made of Polypropylene  
Tread: TENTEprene (thermoplastic rubber), grey non-marking, plain bearing  
Swivel Type A    Fixed Type A    Brake Type A

**3 Castor Wheels**

housing and wheels made from high grade synthetic materials, with integrated threadguards, all metal parts are yellow passivated, wheel centre made of Polypropylene  
Tread: TENTEprene (thermoplastic rubber), grey nonmarking  
Swivel Type B    Fixed Type B    Brake Type B



Size (mm)	Load Capacity (kg)	Plate fitting / bolt hole	Art.No.	Art.No.	Art.No.
			1	1	1
			Swivel Type A	Fixed Type A	Brake Type A
50	40	p-fit	2470 DIK 050 P40	2478 DIK 050 P40	2475 DIK 050 P40
75	55	p-fit	2470 DIK 075 P40	2478 DIK 075 P60	2477 DIK 075 P40
100	80	p-fit	2470 DIK 100 P50	2478 DIK 100 P50	2477 DIK 100 P50
125	100	p-fit	2470 DIK 125 P50	2478 DIK 125 P50	2477 DIK 125 P50
150	100	p-fit	2470 DIK 150 P50	2478 DIK 150 P50	2477 DIK 150 P50
50	40	hole 11	2470 DIK 050 P30		2475 DIK 050 P30
75	55	hole 11	2470 DIK 075 P30		2477 DIK 075 P30
100	80	hole 11	2470 DIK 100 P30		2477 DIK 100 P30
125	100	hole 11	2470 DIK 125 P30		2477 DIK 125 P30
150	100	hole 11	2470 DIK 150 P30		2477 DIK 150 P30



Size (mm)	Load Capacity (kg)	p-fit	Art.No.	Art.No.	Art.No.
			2	2	2
			Swivel Type A	Fixed Type A	Brake Type A
50	50	p-fit	2470 PJI 050 P40	2478 PJI 050 P40	2475 PJI 050 P40
75	75	p-fit	2470 PJO 075 P40	2478 PJO 075 P60	2477 PJO 075 P40
100	80	p-fit	2470 PJO 100 P50	2478 PJO 100 P50	2477 PJO 100 P50
125	100	p-fit	2470 PJO 125 P50	2478 PJO 125 P50	2477 PJO 125 P50
150	100	p-fit	2470 PJO 150 P50	2478 PJO 150 P50	2477 PJO 150 P50
50	50	hole 11	2470 PJI 050 P30		2475 PJI 050 P30
75	50	hole 11	2470 PJO 075 P30		2477 PJO 075 P30
100	75	hole 11	2470 PJO 100 P30		2477 PJO 100 P30
125	100	hole 11	2470 PJO 125 P30		2477 PJO 125 P30
150	100	hole 11	2470 PJO 150 P30		2477 PJO 150 P30



Size (mm)	Load Capacity (kg)	p-fit	Art.No.	Art.No.	Art.No.
			3	3	3
			Swivel Type B	Fixed Type B	Brake Type B
100	100		5320 PJP 100 P50	5328 PJP 100 P50	5327 PJP 100 P50
125	100		5320 PJP 125 P50	5328 PJP 125 P50	5327 PJP 125 P50



The World in Motion.



Load Size (mm)	Capacity (kg)	Art.No.	Type	Art.No.	Type
50	70	2970 U00 050 P40	Swivel Type A	2975 U00 050 P40	Brake Type C
50	70	2970 U00 050 P30	Swivel Type A	2975 U00 050 P30	Brake Type C

bolt hole 11 mm



Load Size (mm)	Capacity (kg)	Art.No.	Type	Art.No.	Type	Art.No.	Type
100	75	3470 DVR 100 P62	Swivel Type A	3478 DVR 100 P62	Fixed Type A	3477 DVR 100 P62	Brake Type A
125	100	3470 DVR 125 P62	Swivel Type A	3478 DVR 125 P62	Fixed Type A	3477 DVR 125 P62	Brake Type A
160	135	3470 DVR 160 P63	Swivel Type A	3478 DVR 160 P63	Fixed Type A	3477 DVR 160 P63	Brake Type A
200	205	3470 DVR 200 P63	Swivel Type A	3478 DVR 200 P63	Fixed Type A	3477 DVR 200 P63	Brake Type A
250	290	4680 DVL 250 P63	Swivel Type A	4688 DVL 250 P63	Fixed Type A	4687 DVL 250 P63	Brake Type A



Load Size (mm)	Capacity (kg)	Art.No.	Type	Art.No.	Type	Art.No.	Type
80	70	3470 PVR 080 P62	Swivel Type A	3478 PVR 080 P62	Fixed Type A	3477 PVR 080 P62	Brake Type A
100	75	3470 PVR 100 P62	Swivel Type A	3478 PVR 100 P62	Fixed Type A	3477 PVR 100 P62	Brake Type A
125	100	3470 PVR 125 P62	Swivel Type A	3478 PVR 125 P62	Fixed Type A	3477 PVR 125 P62	Brake Type A
160	135	3470 PVR 160 P63	Swivel Type A	3478 PVR 160 P63	Fixed Type A	3477 PVR 160 P63	Brake Type A
200	205	3470 PVR 200 P63	Swivel Type A	3478 PVR 200 P63	Fixed Type A	3477 PVR 200 P63	Brake Type A



Load Size (mm)	Capacity (kg)	Art.No.	Type	Art.No.	Type	Art.No.	Type
80	200	3470 U00 080 P62	Swivel Type A	3478 U00 080 P62	Fixed Type A	3477 U00 080 P62	Brake Type A
100	200	3470 U00 100 P62	Swivel Type A	3478 U00 100 P62	Fixed Type A	3477 U00 100 P62	Brake Type A
125	275	3470 U00 125 P63	Swivel Type A	3478 U00 125 P63	Fixed Type A	3477 U00 125 P63	Brake Type A
160	350	3470 U00 160 P63	Swivel Type A	3478 U00 160 P63	Fixed Type A	3477 U00 160 P63	Brake Type A
200	350	3470 U00 200 P63	Swivel Type A	3478 U00 200 P63	Fixed Type A	3477 U00 200 P63	Brake Type A



Load Size (mm)	Capacity (kg)	Art.No.	Type	Art.No.	Type	Art.No.	Type
80	125	3470 POR 080 P62	Swivel Type A	3478 POR 080 P62	Fixed Type A	3477 POR 080 P62	Brake Type A



Load Size (mm)	Capacity (kg)	Art.No.	Type	Art.No.	Type	Art.No.	Type
100	200	3470 UOR 100 P62	Swivel Type A	3478 UOR 100 P62	Fixed Type A	3477 UOR 100 P62	Brake Type A
125	250	3470 UOR 125 P63	Swivel Type A	3478 UOR 125 P63	Fixed Type A	3477 UOR 125 P63	Brake Type A
160	350	3470 UOR 160 P63	Swivel Type A	3478 UOR 160 P63	Fixed Type A	3477 UOR 160 P63	Brake Type A
200	350	3470 UOR 200 P63	Swivel Type A	3478 UOR 200 P63	Fixed Type A	3477 UOR 200 P63	Brake Type A

### 1 Castor Wheels

housing made of pressed steel, zinc-chromatised, wheel made of Polyamide, plain bearing  
Swivel Type A Swivel Type C

### 2 Castor Wheels

housing made of pressed steel, zinc-chromatised, dustguard, wheel centre made of pressed steel  
Tread: solid rubber, black, roller bearing  
Swivel Type A Fixed Type A Brake Type A

### 3 Castor Wheels

housing made of pressed steel, zinc-chromatised, dustguard, wheel centre made of polypropylene  
Tread: solid rubber, black, roller bearing  
Swivel Type A Fixed Type A Brake Type A

### 4 Castor Wheels

housing made of pressed steel, zinc-chromatised, dustguard, wheel centre made of polyamide, white, plain bearing  
Swivel Type A Fixed Type A Brake Type A

### 5 Castor Wheels

housing made of pressed steel, zinc-chromatised, dustguard, wheel centre made of polypropylene, dark grey, roller bearing  
Swivel Type A Fixed Type A Brake Type A

### 6 Castor Wheels

housing made of pressed steel, zinc-chromatised, dustguard, wheel centre made of polyamide, dark grey, roller bearing.  
All types optionally available in white colour.  
Size 200mm available in white colour only.  
Swivel Type A Fixed Type A Brake Type A



The World in Motion.



\* to order the blue version please add »blue« to the Art.No.

Load Size (mm)	Capacity (kg)	Art.No. 1 Swivel Type A	Art.No. 1 Fixed Type A	Art.No. 1 Brake Type A
100	160	3470 UFR 100 P62*	3478 UFR 100 P62*	3477 UFR 100 P62*
125	250	3470 UFR 125 P62*	3478 UFR 125 P62*	3477 UFR 125 P62*
160	300	3470 UFR 160 P63	3478 UFR 160 P63	3477 UFR 160 P63
200	400	3470 UFR 200 P63	3478 UFR 200 P63	3477 UFR 200 P63



Load Size (mm)	Capacity (kg)	Art.No. 2 Swivel Type C	Art.No. 2 Fixed Type C	Art.No. 2 Brake Type D
125	300	4680 IEP 125 P63	4688 IEP 125 P63	4687 IEP 125 P63
160	350	4680 IEP 160 P63	4688 IEP 160 P63	4687 IEP 160 P63
200	400	4680 IEP 200 P63	4688 IEP 200 P63	4687 IEP 200 P63
250	450	4680 IEP 250 P63	4688 IEP 250 P63	4687 IEP 250 P63



Load Size (mm)	Capacity (kg)	Art.No. 3 Swivel Type D	Art.No. 3 Fixed Type D	Art.No. 3 Brake Type E
100	400	9680 ITP 100 P63	9688 ITP 100 P63	-
125	500	9680 ITP 125 P63	9688 ITP 125 P63	9682 ITP 125 P63
160	800	9680 ITP 160 P63	9688 ITP 160 P63	9682 ITP 160 P63
200	800	9680 ITP 200 P63	9688 ITP 200 P63	9682 ITP 200 P63
250	1000	9680 ITP 250 P63	9688 ITP 250 P63	9682 ITP 250 P63



Load Size (mm)	Capacity (kg)	Art.No. 4 Swivel Type A	Art.No. 4 Fixed Type A	Art.No. 4 Brake Type A
200	75	3470 PPO 200 P63	3478 PPO 200 P63	3477 PPO 200 P63

**1 Castor Wheels grey or blue\***

housing made of pressed steel, zinc-chromatised, dustguard, wheel centre made of polypropylene  
 Tread: elastic-tyre, grey / blue, non-marking, roller bearing  
 Swivel Type A Fixed Type A Brake Type A  
 \*to order the blue version please add »blue« to the Art.No.

**2 Heavy Duty Castor Wheels**

housing made of very heavy pressed steel, reinforced, yellow zinc plated, wheel centre made of aluminium  
 Tread: black elastic-tyre, vulcanized, precision ball bearing  
 Swivel Type C Fixed Type C Brake Type D

**3 Heavy Duty Castor Wheels**

housing and plate steel-welded, zinc-chromatised, wheel centre made of Aluminium  
 Tread: Polyurethane, casted, precision ball bearing  
 Swivel Type D Fixed Type D Brake Type E

**4 Castor Wheels (e.g. for Hotel Trolleys)**

housing and plate steel-welded, zinc-chromatised with fixing plate, wheel center made of polypropylene  
 Thread: pneumatic tyre (grey), plain bearing, rip profile  
 Fixed Type Brake Type

**5 TENTE brand Castor Wheels for Shopping Trolleys**

swivel castor, housing made of pressed steel, zinc-chromatised, double ball bearing swivel head, wheel axle with nut, wheel centre made of Polypropylene.  
 Tread: TENTEprene (thermoplastic rubber), grey non-marking, precision ball bearing, with threadguards, bolt hole

**5A Size 100 mm / load capacity 100 kg bolt hole 11**  
 Art.No **2370 PJP 100 P30**

**5B Size 125 mm / load capacity 100 kg bolt hole 13**  
 Art.No **2370 PJP 125 P30**

**6 Walkway Castors - Automatic Wheel Brake**

housing made of pressed steel, zinc chromatised, double ball bearing swivel head, wheel axle with nut, wheel centre made of Polyurethane.  
 Tread: Polyurethane, 4 tracks, selfcleaning between tracks, with threadguards, precision ball bearing, distances between tracks: approx. 4.5 mm, track width: approx. 4.0 mm, load capacity 80 / 40kgs/castor on walkways, bolt hole 12.3

**6A with break shoe**  
**Size 100 mm** Art.No **2875 QMP 100 R30R**  
**Size 100 mm** Art.No **2875 QMP 100 R30L**

**6B with integrated break shoe**  
**Size 125 mm** Art.No **2875 QMP 125 P30**



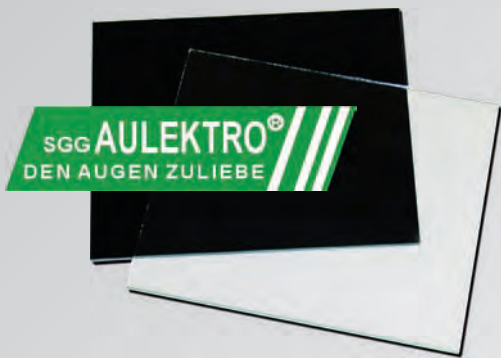

## 1 Dark Welding Glasses

DIN 4646/4647

**1A size: 50 x 105 mm****1B size: 51 x 108 mm**

## 2 Clear Welding Glasses

DIN 4646/4647, thickness 2.0 mm

**2A size: 50 x 105 mm**Art.No. **50105/K****2B size: 51 x 108 mm**Art.No. **51108/K**

## 3 Heavy Duty Electrode Holders

with pressure spring,

brass version, 60% duty cycles

## 4 Earth Clamps for Welders

with cable-shoe connection

## 5 Welding Electrode Holders

- export version - fully insulated, black

## 6 Connectors for Welding Cables

with 13 mm pin

**6A** male-plug**6B** female-socket

## 7 Eurostar with clear anti-fog polycarbonate lens

polycarbonate safety spectacles with easy-to-replace, protective lens with toughened coating and integrated side-protection - the temples are easily length-adjustable - in polybag packing

Art.No. **0453 0000 02 CSV** frame blackArt.No. **0455 0000 02 CSV** frame blue

## 8 Eurostar 1400 with clear anti-fog polycarbonate lens

light and trendy spectacle for safety- as well as for sports' purposes - the smooth nose-bridge, together with the rubber inserts in the temples guarantees a perfect fit to any headsize - in polybag packing

Art.No. **0486 0000 02 CSV**

## 9 Helico 2004 with clear polycarbonate lens

economic version of Helico goggles, with colourless soft PVC body (cadmium free) and 4 ventilation, openings - can be worn over any type of prescription glasses - the elastic headband is easy to adjust - in polybag packing

Art.No. **0156 0000 02 PF**

## 10 Helico Vento 2000 with clear polycarbonate lens

this type of goggle guarantees excellent ventilation due to perforations all around the frame - with colourless soft PVC body (cadmium free) can be worn over any type of prescription glasses - the elastic headband is easy to adjust - in polybag packing

Art.No. **0168 0000 02 PF**

Shade	1A	1B
9	50105/9	51108/9
10	50105/10	51108/10
11	50105/11	51108/11
12	50105/12	51108/12

Cable Connection (sqmm)	Rating Amp	3
25/35	200	512.D255
35/50	300	512.D256
50/70	400	512.D257
70/95	500	512.D258
70/95	600	512.D259

Amp	4
300	4165
400	4166
600	4167

Amp	5
300	3102-300
400	3102-400
500	3107-500
600	3107-600

Size (sqmm)	6A
10-25	511.0005
35-50	511.0015
50-70	511.0031
70-95	511.0042

	6B
10-25	511.0003
35-50	511.0013
50-70	511.0029
70-95	511.0040



- 1 Flippo Typ II**  
with clear polycarbonate lens and dark protection lens  
welder's goggle - the new version of the legendary Flippo has combined wearing comfort and design - with the wide surface contact area and the 25 mm wide elastic headband  
- shade protection #5 - body made of soft PVC - in polybag packing

Art.No. **0111 0000 02 PFE5** yellow frame



- 2 Flippo 2004**  
with clear polycarbonate lens and dark protection lens  
welder's goggle - this classic version of the Flippo has 4 ventilation openings  
- can be worn over any type of prescription glasses  
- the elastic headband is easy to adjust  
- body made of soft PVC - in polybag packing

Art.No. **0136 0000 02 PF** yellow frame



- 3 Weliglasses Typ II**  
with unicarbonated plastic protection lens level #5 - dia. 50 mm

the adapted design, the wide headband and the comfortable surface contact areas are greatly enhanced features of the Weliglas  
- the good ventilation ensures excellent air circulation, which makes it even more comfortable to wear  
- body made of soft PVC  
- shade protection #5 - in polybag packing

Art.No. **0195 0000 02 EG5** yellow frame



- 4 Safety Welding Goggles**  
**Modell 879**

clear glasses, DIN L, size: round dia. 50 mm

Art.No. **187901740** beige frame

**Modell 879**

with green ATHERMAL glasses, size: round dia. 50 mm

Art.No. **187901105** beige frame, shade protection #5

Art.No. **187901106** beige frame, shade protection #6



- 5 Uniheads Typ II**

face protection carrier for large visors where simple goggles or safety spectacles are not sufficient  
- with two adjustment settings, this product can be adapted to any head size

Art.No. **0801 3001 00**



**Claro 3000**

face visors suitable to be used with Unihead Typ II

Art.No. **9908 0320 00 HF**

with clear anti-fog acetate visor

Art.No. **9908 0360 00 EG5**

polycarbonate visor shade #5



## 1 Protective Hand-Shields

### 1A - Type EURO-STAR

thermostable up to 100°C - straight, made of black ABS material, complete with lens frame and handle

Art.No. **21400A** glass size: 51 x 108 mm

Art.No. **21400** glass size: 90 x 110 mm

### 1B - Type EURO-HANDY 2000

thermostable up to 120°C - inclined

Art.No. **200100A** glass size: 51 x 108 mm

Art.No. **200100** glass size: 90 x 110 mm



## 2 Welding Helmets Type EURO



**2A** made of black ABS material, complete with lens

Art.No. **219400A** glass size: 51 x 108 mm

Art.No. **219400** glass size: 90 x 110 mm

**2B** fibre-glass reinforced

Art.No. **219411A** glass size: 51 x 108 mm

Art.No. **219411** glass size: 90 x 110 mm



## 3 Particulate Respirator Filters Type ROCKMAN

designed spaciouly to fit large variety of faces - supersoft inner sealing - equipped with newly designed exhalation valve - layers ultrasonic welded

**3A** Filtering Face Piece: solid particulate material nontoxic dust

Art.No. **7010-FFP1** without valve

Art.No. **7011-FFP1** with valve

**3B** Filtering Face Piece: solid particulate material reduced toxic dust

Art.No. **7020-FFP2** without valve

Art.No. **7021-FFP2** with valve

Art.No. **7222-FFP2** with valve and carbon layers against offensive smell

## 4 Particulate Respirator Halfmasks

### Type ROCKMAN

anatomically perfectly fitting mask body made of rubber, covering the whole chin - the large exhalation valve allows easy exhalation - easy size adjustment thanks to simply adjustable headband

Respiration Filter Standards:

P: solid parcticulate material - class 1,2,3

A: organic gases and vapours flash point > 65° - class 1,2,3

A: organic gases and vapours flash point < 65° - class 1,2,3

B: inorganic gases and vapours - like: prussic acid - class 1,2,3

E: acid gases - like: salt acid - class 1,2,3

K: ammonia and organic ammonia derivates - class 1,2,3

Art.No. **7310** single cartridge

Art.No. **7320** twin cartridge

### Suitable filters

Protection Rating	Art.No.
P2	<b>73P2</b>
P3	<b>73P3</b>
A1	<b>73A1</b>
A1/P2	<b>73A1/P2</b>
ABEK	<b>73ABEK</b>
E1	<b>73E1</b>
K1	<b>73K1</b>

